

## GaAs pHEMT MMIC 3 WATT POWER AMPLIFIER SMT WITH POWER DETECTOR, 12 - 16 GHz



### Typical Applications

The HMC995LP5GE is ideal for:

- Point-to-Point Radios
- Point-to-Multi-Point Radios
- VSAT & SATCOM
- Military & Space

### Features

- Integrated Power Detector
- Saturated Output Power: 35.5 dBm @ 24% PAE
- High Output IP3: 41 dBm
- High Gain: 27 dB
- DC Supply: +5V to +7V @ 1200 mA
- No External Matching Required

### Functional Diagram

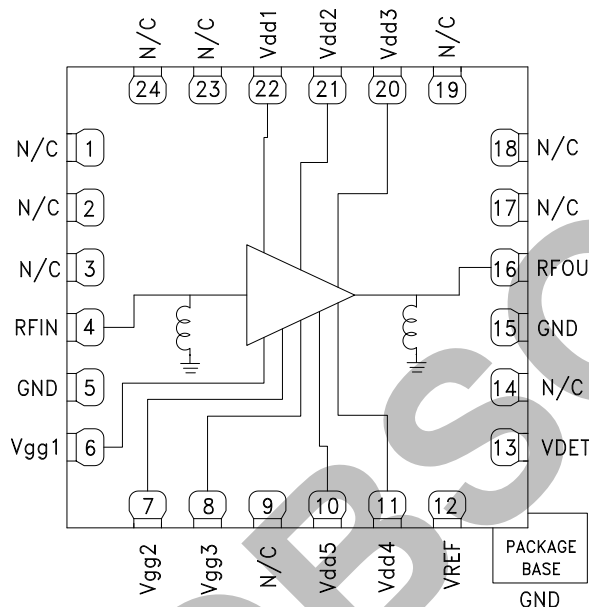

### General Description

The HMC995LP5GE is a 4 stage GaAs pHEMT MMIC 2 Watt Power Amplifier with an integrated temperature compensated on-chip power detector which operates between 12 and 16 GHz. The HMC995LP5GE provides 27 dB of gain, 35.5 dBm of saturated output power, and 24% PAE from a +7V supply. The HMC995LP5GE exhibits excellent linearity and is optimized for high capacity digital microwave radio. It is also ideal for 13.75 to 14.5 GHz Ku Band VSAT transmitters as well as SATCOM applications. The HMC995LP5GE amplifier I/Os are internally matched to 50 Ohms and is packaged in a leadless QFN 5x5 mm surface mount package and requires no external matching components.

### Electrical Specifications

$T_A = +25^\circ \text{C}$ ,  $V_{dd} = V_{dd1} = V_{dd2} = V_{dd3} = V_{dd4} = V_{dd5} = +7\text{V}$ ,  $I_{dd} = 1200 \text{mA}$  [1]

Parameter	Min.	Typ.	Max.	Units
Frequency Range		12 - 16		GHz
Gain [3]	24	27		dB
Gain Variation Over Temperature		0.03		dB/ °C
Input Return Loss		9		dB
Output Return Loss		15		dB
Output Power for 1 dB Compression (P1dB)	32	34.5		dBm
Saturated Output Power (P <sub>sat</sub> )		35.5		dBm
Output Third Order Intercept (IP3) <sup>[2]</sup>		41		dBm
Total Supply Current (I <sub>dd</sub> )		1200		mA

[1] Adjust (V<sub>gg1</sub>=V<sub>gg2</sub>=V<sub>gg3</sub>) between -2 to 0V to achieve I<sub>dd</sub> = 1200mA typical.

[2] Measurement taken at +7V @ 1200mA, P<sub>out</sub> / Tone = +22 dBm

[3] Board loss subtracted out

**GaAs pHEMT MMIC 3 WATT POWER AMPLIFIER SMT WITH POWER DETECTOR, 12 - 16 GHz**



**Broadband Gain & Return Loss vs. Frequency**

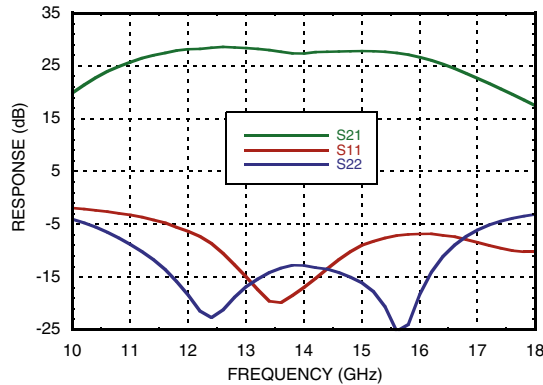

**Gain vs. Temperature [1]**

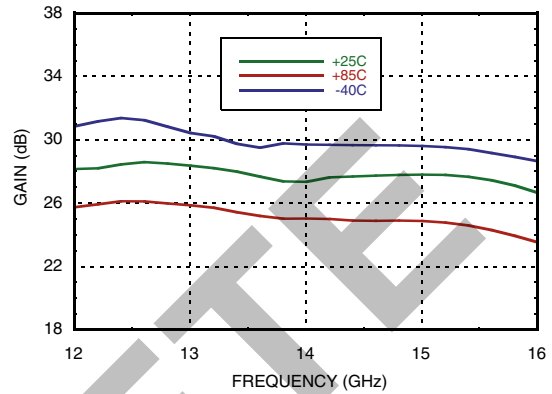

**Input Return Loss vs. Temperature**

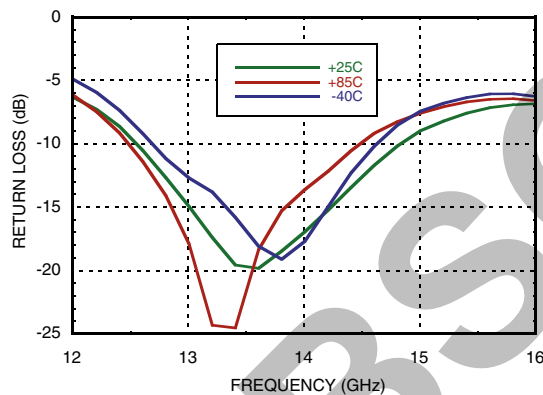

**Output Return Loss vs. Temperature**

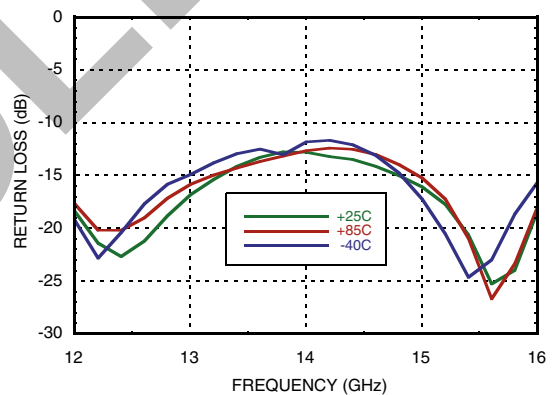

**P1dB vs. Temperature**

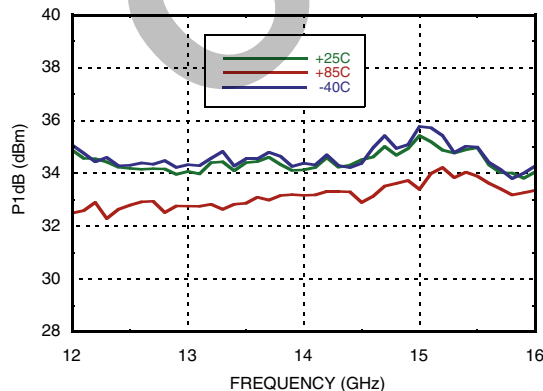

**P1dB vs. Supply Voltage**

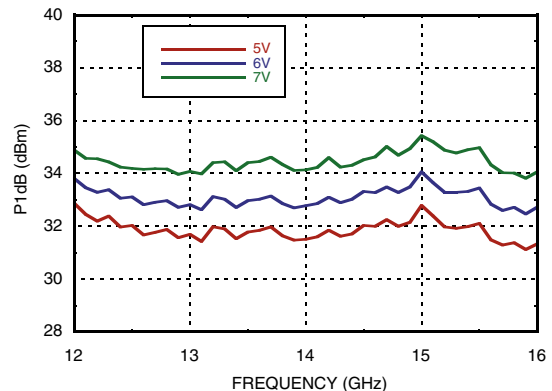

Information furnished by Analog Devices is believed to be accurate and reliable. However, no responsibility is assumed by Analog Devices for its use, nor for any infringements of patents or other rights of third parties that may result from its use. Specifications subject to change without notice. No license is granted by implication or otherwise under any patent or patent rights of Analog Devices. Trademarks and registered trademarks are the property of their respective owners.

For price, delivery, and to place orders: Analog Devices, Inc., One Technology Way, P.O. Box 9106, Norwood, MA 02062-9106 Phone: 781-329-4700 • Order online at [www.analog.com](http://www.analog.com) Application Support: Phone: 1-800-ANALOG-D



**GaAs pHEMT MMIC 3 WATT POWER AMPLIFIER SMT WITH POWER DETECTOR, 12 - 16 GHz**

**Psat vs. Temperature**

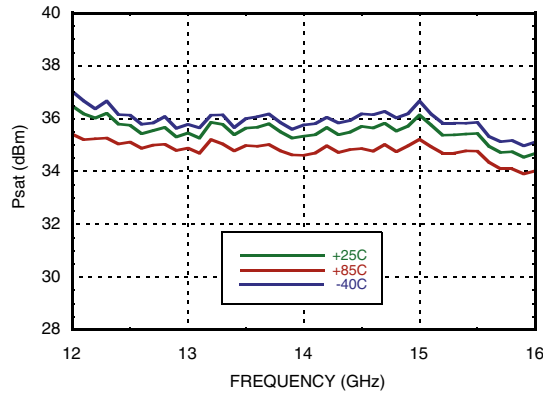

**Psat vs. Supply Voltage**

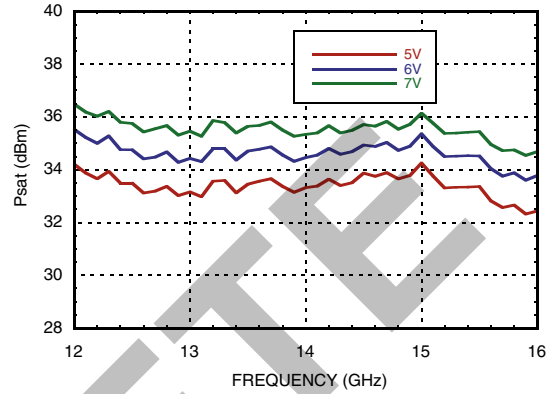

**P1dB vs. Supply Current (Idd)**

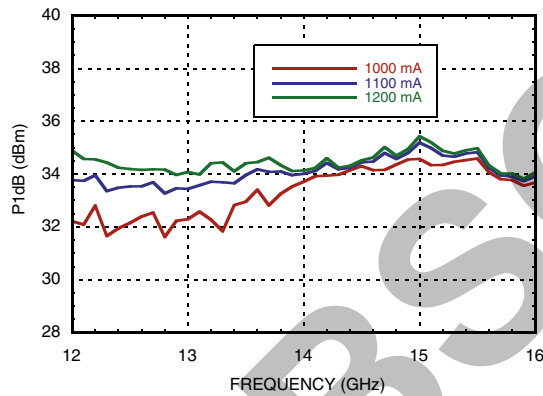

**Psat vs. Supply Current (Idd)**

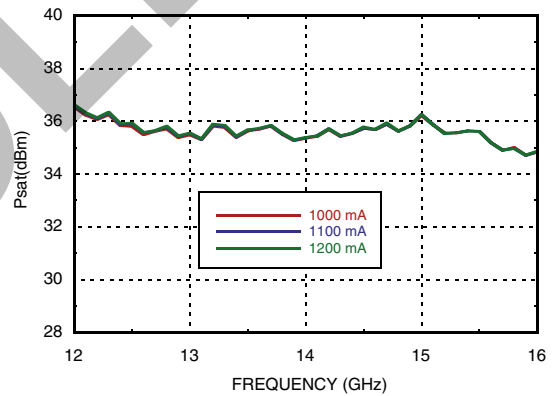

**Output IP3 vs. Temperature, Pout/Tone = +22 dBm**

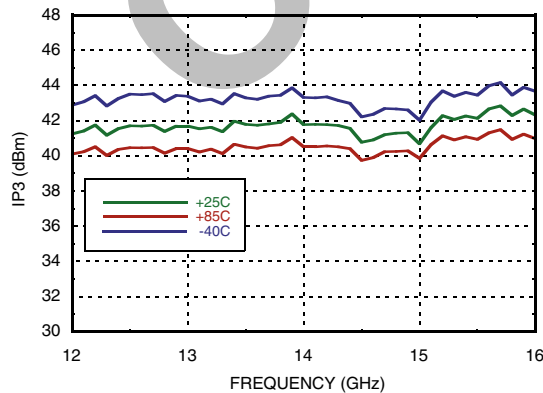

**Output IP3 vs. Supply Current, Pout/Tone = +22 dBm**

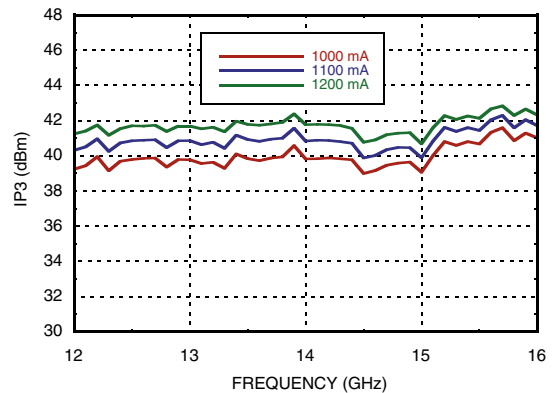

Information furnished by Analog Devices is believed to be accurate and reliable. However, no responsibility is assumed by Analog Devices for its use, nor for any infringements of patents or other rights of third parties that may result from its use. Specifications subject to change without notice. No license is granted by implication or otherwise under any patent or patent rights of Analog Devices. Trademarks and registered trademarks are the property of their respective owners.

For price, delivery, and to place orders: Analog Devices, Inc., One Technology Way, P.O. Box 9106, Norwood, MA 02062-9106 Phone: 781-329-4700 • Order online at [www.analog.com](http://www.analog.com) Application Support: Phone: 1-800-ANALOG-D

**GaAs pHEMT MMIC 3 WATT POWER AMPLIFIER SMT WITH POWER DETECTOR, 12 - 16 GHz**



**Output IP3 vs. Supply Voltage, Pout/Tone = +22 dBm**

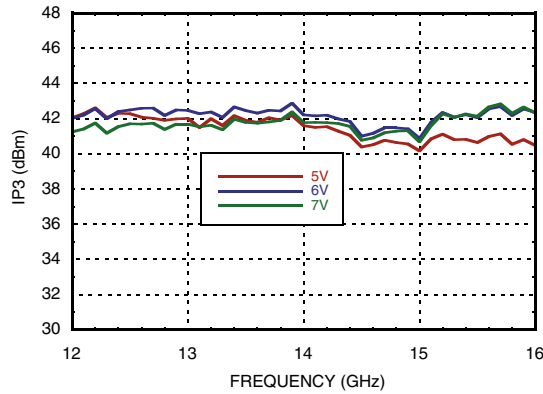

**Output IM3 @ Vdd = +5V**

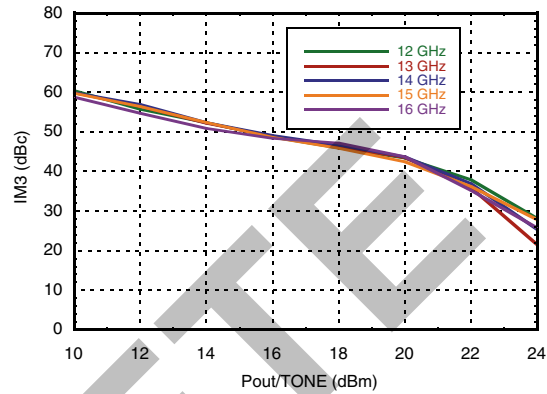

**Output IM3 @ Vdd = +6V**

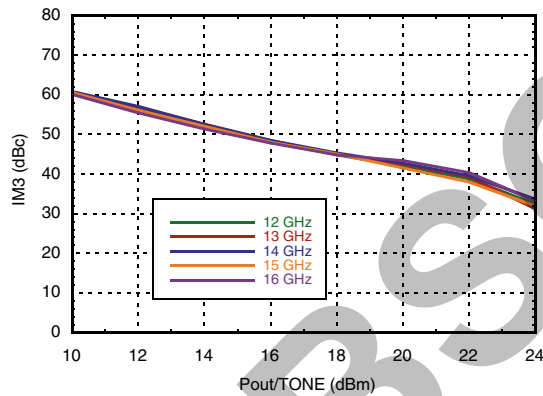

**Output IM3 @ Vdd = +7V**

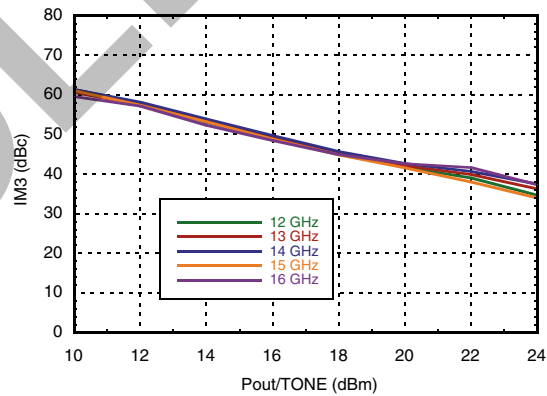

**Power Compression @ 13 GHz**

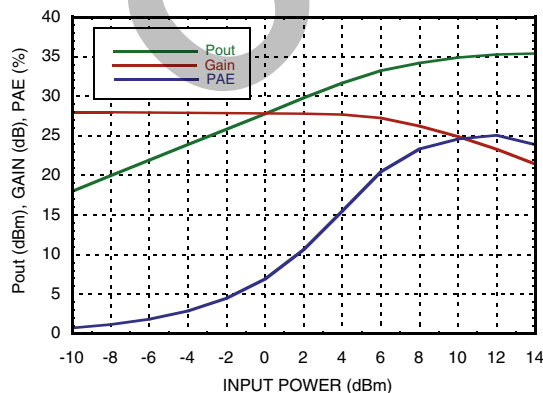

**Power Compression @ 15 GHz**

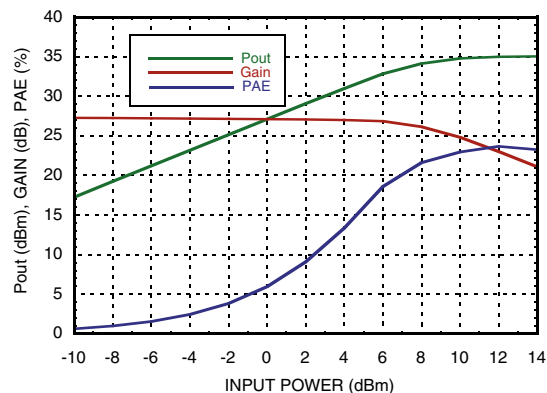

Information furnished by Analog Devices is believed to be accurate and reliable. However, no responsibility is assumed by Analog Devices for its use, nor for any infringements of patents or other rights of third parties that may result from its use. Specifications subject to change without notice. No license is granted by implication or otherwise under any patent or patent rights of Analog Devices. Trademarks and registered trademarks are the property of their respective owners.

For price, delivery, and to place orders: Analog Devices, Inc., One Technology Way, P.O. Box 9106, Norwood, MA 02062-9106 Phone: 781-329-4700 • Order online at [www.analog.com](http://www.analog.com) Application Support: Phone: 1-800-ANALOG-D

**GaAs pHEMT MMIC 3 WATT POWER AMPLIFIER SMT WITH POWER DETECTOR, 12 - 16 GHz**



**Detector Voltage vs. Frequency & Temperature**

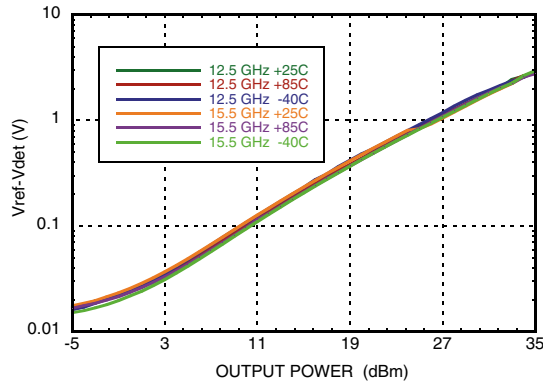

**Reverse isolation vs. Temperature**

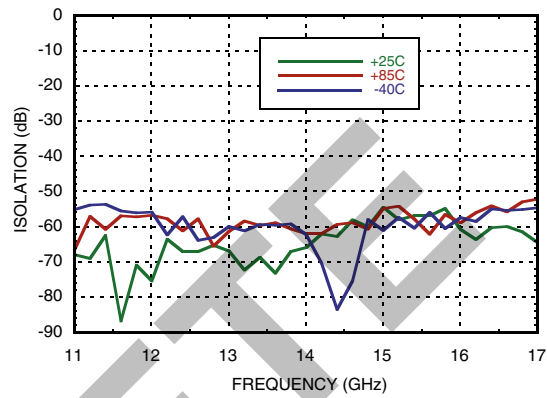

**Gain & Power vs. Supply Current @ 14 GHz**

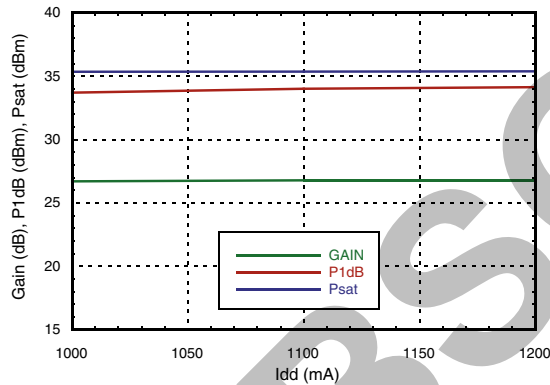

**Gain & Power vs. Supply Voltage @ 14 GHz**

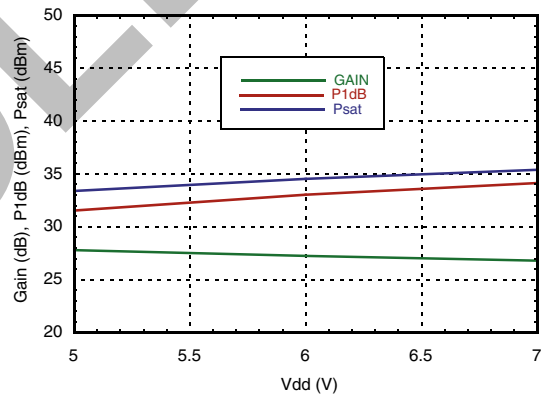

**Power Dissipation**

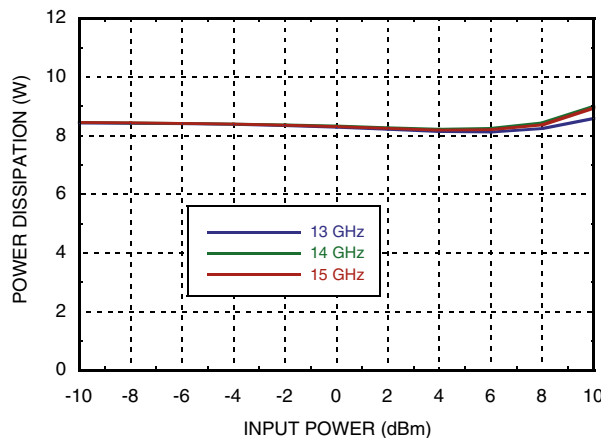

Information furnished by Analog Devices is believed to be accurate and reliable. However, no responsibility is assumed by Analog Devices for its use, nor for any infringements of patents or other rights of third parties that may result from its use. Specifications subject to change without notice. No license is granted by implication or otherwise under any patent or patent rights of Analog Devices. Trademarks and registered trademarks are the property of their respective owners.

For price, delivery, and to place orders: Analog Devices, Inc., One Technology Way, P.O. Box 9106, Norwood, MA 02062-9106 Phone: 781-329-4700 • Order online at [www.analog.com](http://www.analog.com) Application Support: Phone: 1-800-ANALOG-D

**GaAs pHEMT MMIC 3 WATT POWER AMPLIFIER SMT  
WITH POWER DETECTOR, 12 - 16 GHz**
**Absolute Maximum Ratings**

Drain Bias Voltage (Vdd1-5)	+8V
RF Input Power (RFIN)	+24 dBm
Channel Temperature	150 °C
Continuous Pdiss (T= 85 °C) (derate 137 mW/°C above 85 °C)	8.9 W
Thermal Resistance (channel to gnd paddle)	7.3 °C/W
Storage Temperature	-65 to +150 °C
Operating Temperature	-40 to +85 °C
ESD Sensitivity (HBM)	Class 1A

**Typical Supply Current vs. Vdd**

Vdd (V)	Idd (mA)
5	1200
6	1200
7	1200

Note: Amplifier will operate over full voltage ranges shown above Vgg adjusted to achieve Idd = 1200 mA



**ELECTROSTATIC SENSITIVE DEVICE  
OBSERVE HANDLING PRECAUTIONS**

OBSOLETE



**GaAs pHEMT MMIC 3 WATT POWER AMPLIFIER SMT WITH POWER DETECTOR, 12 - 16 GHz**

**Outline Drawing**

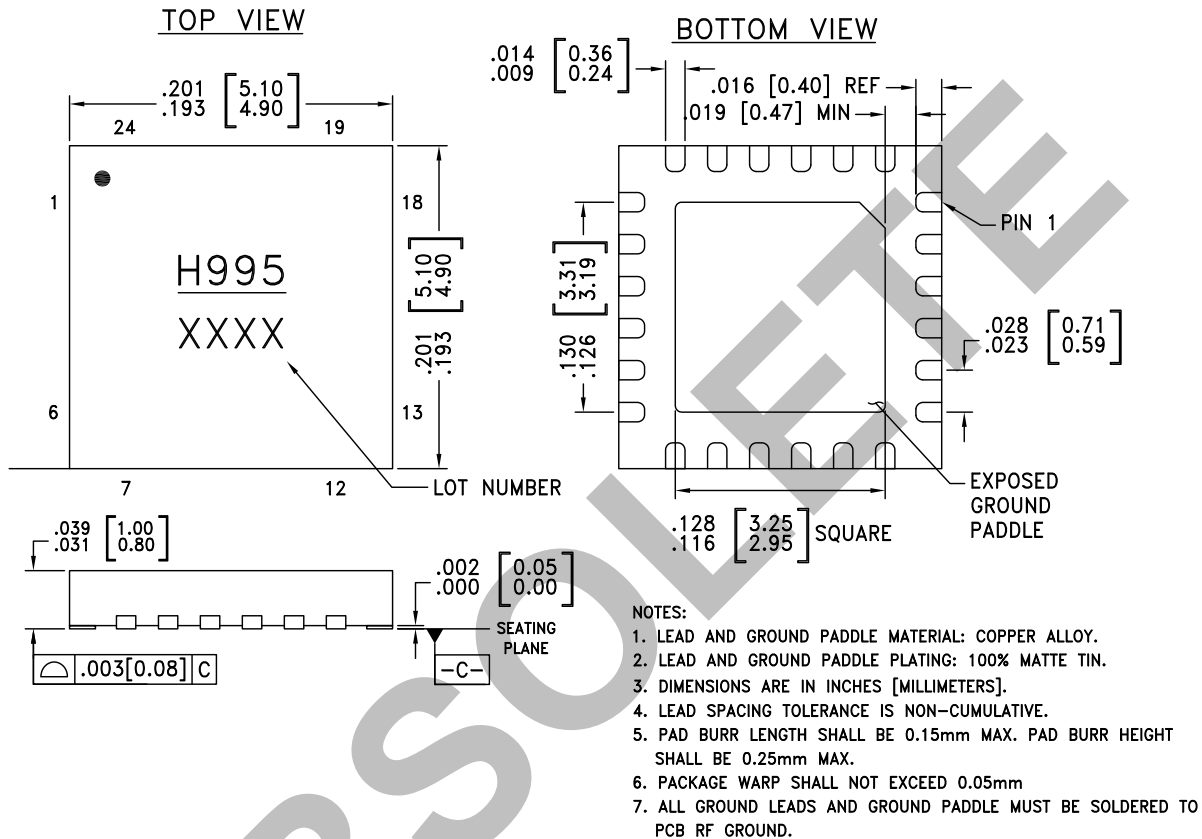

**Package Information**

Part Number	Package Body Material	Lead Finish	MSL Rating	Package Marking <sup>[1]</sup>
HMC995LP5GE	RoHS-compliant Low Stress Injection Molded Plastic	100% matte Sn	MSL3 <sup>[2]</sup>	H995 XXXX



[1] 4-Digit lot number XXXX

[2] Max peak reflow temperature of 260 °C

## GaAs pHEMT MMIC 3 WATT POWER AMPLIFIER SMT WITH POWER DETECTOR, 12 - 16 GHz

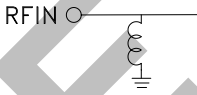

### Pin Descriptions

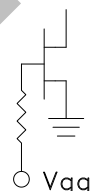
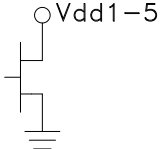
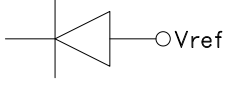
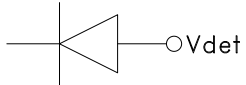
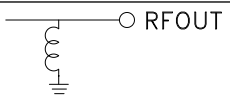
Pin Number	Function	Description	Interface Schematic
1-3, 9, 14 17-19, 23, 24	N/C	These pins are not connected internally, however all data shown herein was measured with these pins connected to RF/DC ground externally.	
4	RFIN	This pad is DC coupled and matched to 50 Ohms.	
5, 15	GND	These pins and package bottom must be connected to RF/DC ground.	
6-8	Vgg1, Vgg2 Vgg3	Gate control for amplifier. External bypass capacitors of 100pF, 10nF and 4.7uF are required. Please follow "MMIC Amplifier Biasing Procedure" App Note.	
10, 11 20-22	Vdd1, Vdd2, Vdd3, Vdd4, Vdd5	Drain bias voltage for the amplifier. External bypass capacitors of 100pF, 10nF and 4.7uF capacitors are required.	
12	Vref	DC voltage of diode biased through external resistor, used for temperature compensation of Vdet. See Application Circuit.	
13	Vdet	DC voltage representing RF output power rectified by diode which is biased through an external resistor. See Application Circuit.	
16	RFOUT	This pin is DC coupled and matched to 50 Ohms.	



**GaAs pHEMT MMIC 3 WATT POWER AMPLIFIER SMT WITH POWER DETECTOR, 12 - 16 GHz**



**Application Circuit**

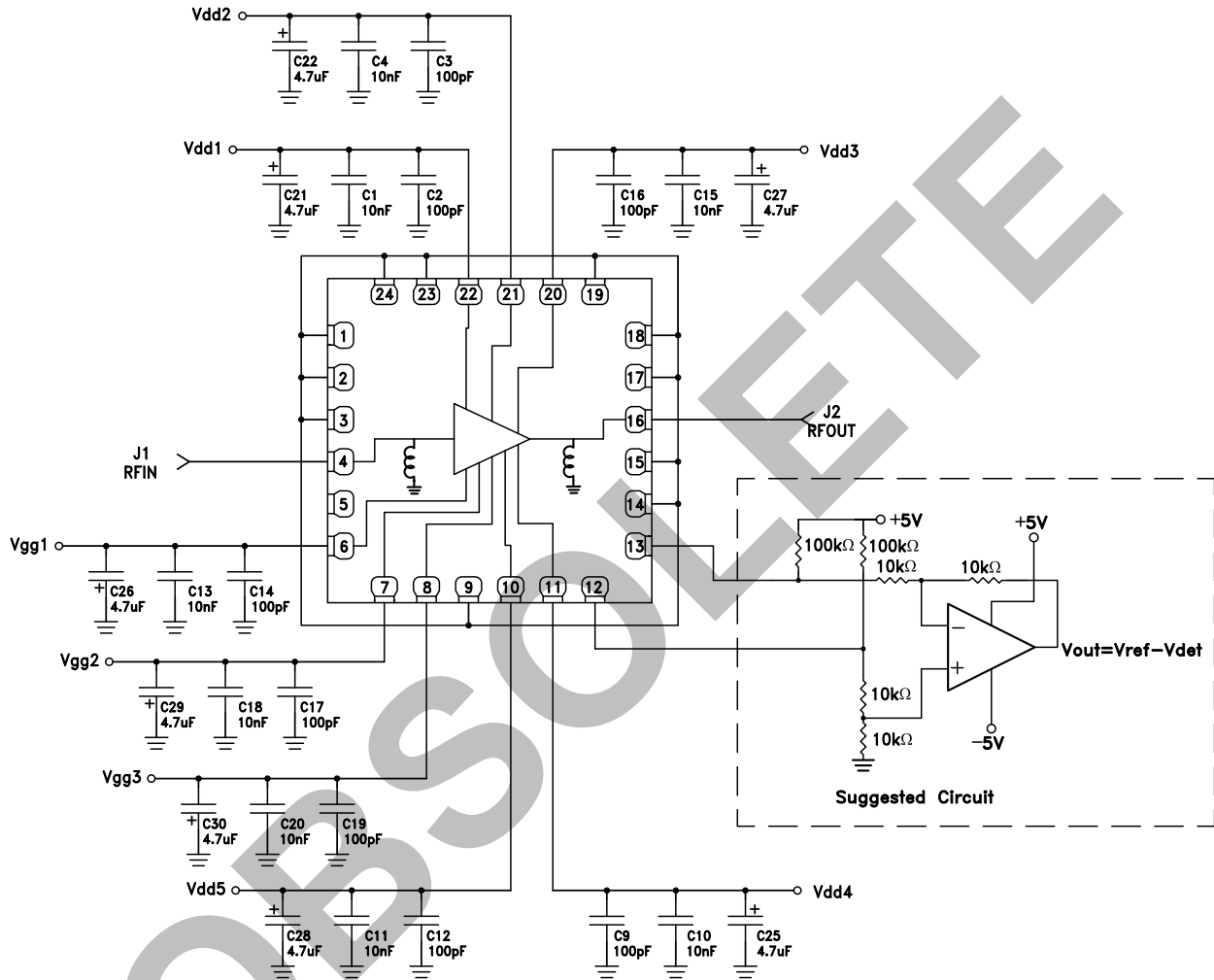

Information furnished by Analog Devices is believed to be accurate and reliable. However, no responsibility is assumed by Analog Devices for its use, nor for any infringements of patents or other rights of third parties that may result from its use. Specifications subject to change without notice. No license is granted by implication or otherwise under any patent or patent rights of Analog Devices. Trademarks and registered trademarks are the property of their respective owners.

For price, delivery, and to place orders: Analog Devices, Inc., One Technology Way, P.O. Box 9106, Norwood, MA 02062-9106 Phone: 781-329-4700 • Order online at [www.analog.com](http://www.analog.com) Application Support: Phone: 1-800-ANALOG-D

## GaAs pHEMT MMIC 3 WATT POWER AMPLIFIER SMT WITH POWER DETECTOR, 12 - 16 GHz



### Evaluation PCB

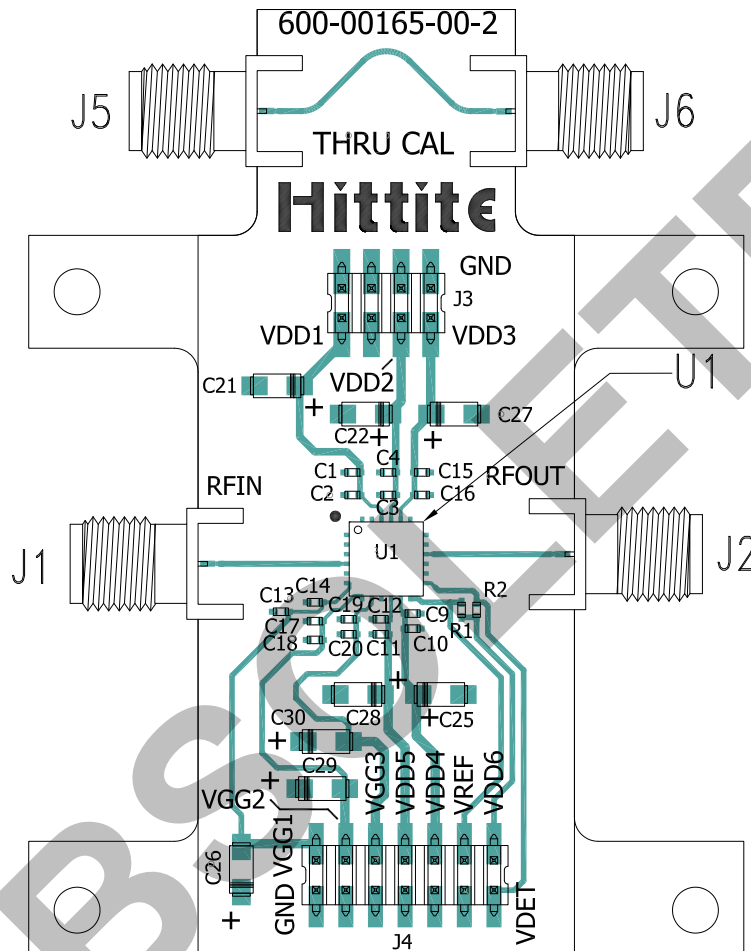

### List of Materials for Evaluation PCB EVAL01-HMC995LP5GE [1]

Item	Description
J1, J2, J5, J6	K Connector SRI
J3, J4	DC Pin
C2, C3, C9, C12, C14, C16, C17, C19	100 pF Capacitor, 0402 Pkg.
C1, C4, C10, C11, C13, C15, C18, C20	10 nF Capacitor, 0402 Pkg.
C21, C22, C25 - C30	4.7uF Capacitor, Case A.
U1	HMC995LP5GE Power Amplifier
PCB	600-00163-00 Evaluation PCB

[1] Reference this number when ordering complete evaluation PCB

[2] Circuit Board Material: Rogers 4350 or Arlon FR4

The circuit board used in the application should use RF circuit design techniques. Signal lines should have 50 Ohm impedance while the package ground leads and exposed paddle should be connected directly to the ground plane similar to that shown. A sufficient number of via holes should be used to connect the top and bottom ground planes. The evaluation board should be mounted to an appropriate heat sink. The evaluation circuit board shown is available from Hittite upon request.