

PIN MMIC HIGH ISOLATION SPDT SWITCH, 2 - 50 GHz

Typical Applications

The HMC975 is ideal for:

- Telecom Infrastructure
- Microwave Radio & VSAT
- Military Radios, Radar & ECM
- Space Systems
- Test Instrumentation

Features

- High Isolation: 45 dB @ 26 GHz
- Low Insertion Loss: 0.9 dB @ 26 GHz
- Series-Shunt Reflective Topology
- Die Size: 1.75 x 1.1 x 0.1 mm

Functional Diagram

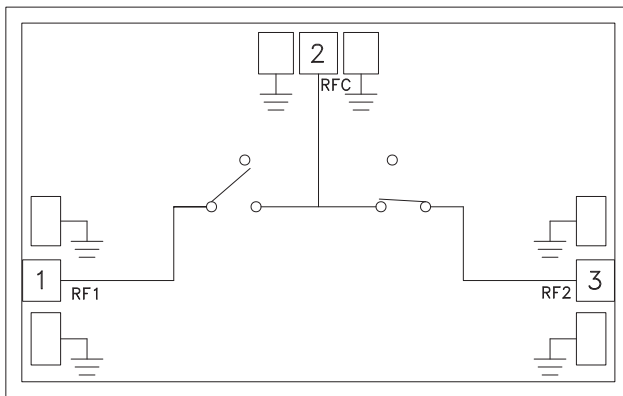

General Description

The HMC975 is a broadband high isolation series shunt reflective PIN SPDT MMIC chip. Covering 2 to 50 GHz, the switch features 45 dB isolation and 0.9 dB insertion loss at 26 GHz. The HMC975 is capable of switching 1/2W of power from 12 to 50 GHz. The HMC975 operates from a positive (30mA) supply current and a negative (-10V) supply voltage. Bias control signals for the switch consists of a reverse bias voltage of -10V typical for ON state and a forward bias current of 30 mA for the OFF state.

Electrical Specifications, $T_A = +25^\circ\text{C}$, With 30mA / -10V Control, 50 Ohm System

Parameter	Frequency	Min.	Typ.	Max.	Units
Insertion Loss RFC to RF1	2 - 15 GHz		0.6	1.0	dB
	15 - 30 GHz		0.9	1.3	dB
	30 - 40 GHz		1.6	2.0	dB
	40 - 50 GHz		1.7	2.1	dB
Insertion Loss RFC to RF2	2 - 15 GHz		0.5	0.9	dB
	15 - 30 GHz		0.8	1.2	dB
	30 - 40 GHz		1.5	1.9	dB
	40 - 50 GHz		1.7	2.1	dB
Isolation	2 - 15 GHz	35	50		dB
	15 - 50 GHz	35	45		dB
Return Loss "On State"	2 - 15 GHz		20		dB
	15 - 50 GHz		12		dB
Input Power for 1 dB Compression	2 - 6 GHz		20		dBm
	6 - 12 GHz		26		dBm
	12 - 50 GHz		28		dBm

Information furnished by Analog Devices is believed to be accurate and reliable. However, no responsibility is assumed by Analog Devices for its use, nor for any infringements of patents or other rights of third parties that may result from its use. Specifications subject to change without notice. No license is granted by implication or otherwise under any patent or patent rights of Analog Devices. Trademarks and registered trademarks are the property of their respective owners.

For price, delivery, and to place orders: Analog Devices, Inc., One Technology Way, P.O. Box 9106, Norwood, MA 02062-9106
 Phone: 781-329-4700 • Order online at www.analog.com
 Application Support: Phone: 1-800-ANALOG-D

**PIN MMIC HIGH ISOLATION
SPDT SWITCH, 2 - 50 GHz**

Insertion Loss, RFC to RF1

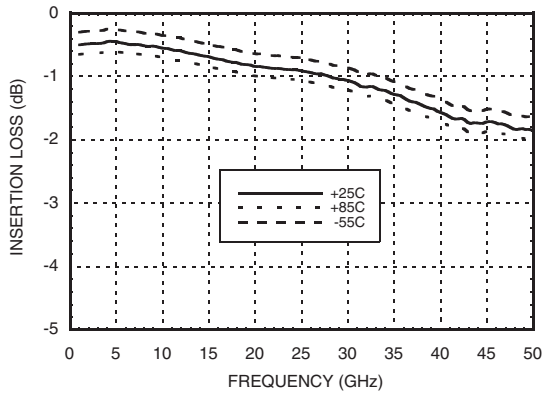

Insertion Loss, RFC to RF2

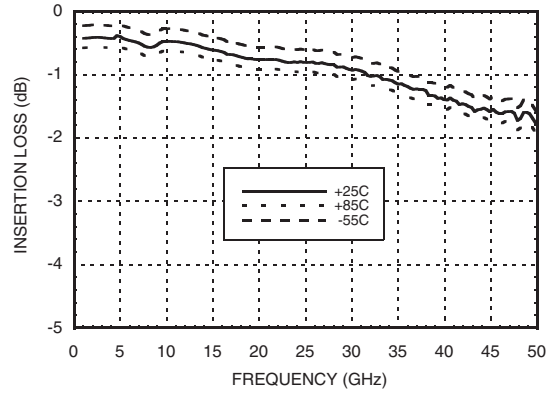

Isolation

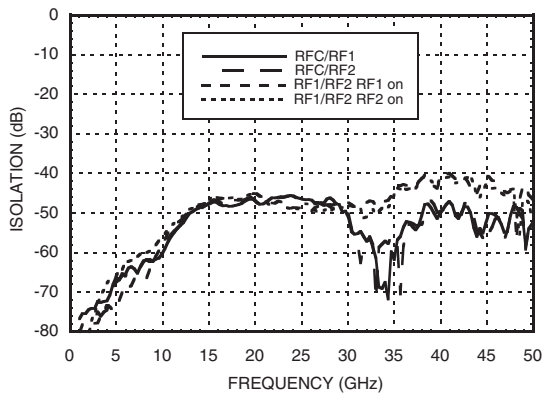

Return Loss

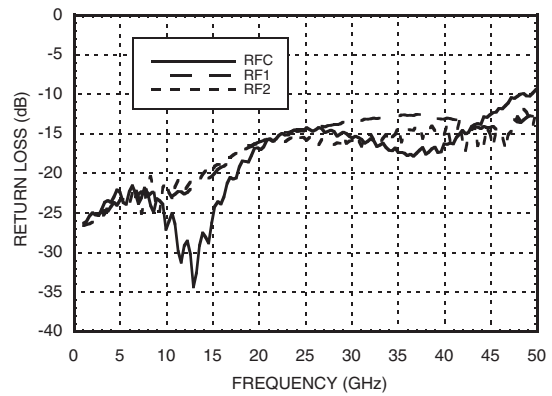

Insertion Loss vs. Pin

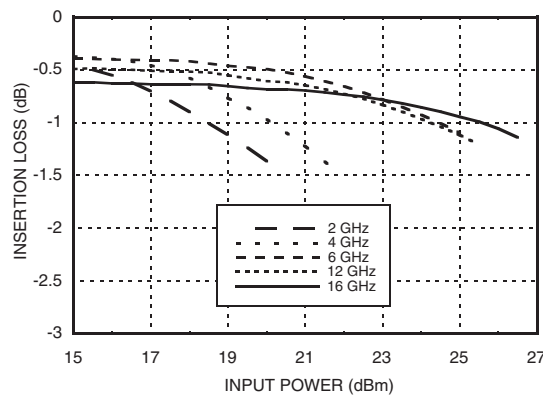

*Isolation data taken with probe on the die

Information furnished by Analog Devices is believed to be accurate and reliable. However, no responsibility is assumed by Analog Devices for its use, nor for any infringements of patents or other rights of third parties that may result from its use. Specifications subject to change without notice. No license is granted by implication or otherwise under any patent or patent rights of Analog Devices. Trademarks and registered trademarks are the property of their respective owners.

For price, delivery, and to place orders: Analog Devices, Inc., One Technology Way, P.O. Box 9106, Norwood, MA 02062-9106 Phone: 781-329-4700 • Order online at www.analog.com Application Support: Phone: 1-800-ANALOG-D

PIN MMIC HIGH ISOLATION SPDT SWITCH, 2 - 50 GHz

Absolute Maximum Ratings

RF Input Power	23 dBm (2 - 6 GHz) 30 dBm (6 - 50 GHz)
Negative Control Voltage	-15V
Forward Bias Current	80 mA
Storage Temperature	-65 to +150 °C
Operating Temperature	-55 to +85 °C



ELECTROSTATIC SENSITIVE DEVICE
OBSERVE HANDLING PRECAUTIONS

7

SWITCHES - CHIP

Control Voltages

State	RFC - RF1	RFC - RF2	CNTL1	CNTL2
1	IL	Isol	-10V	+30mA / 1.29V
2	Isol	IL	+30mA / 1.29V	-10V

Equivalent Schematic

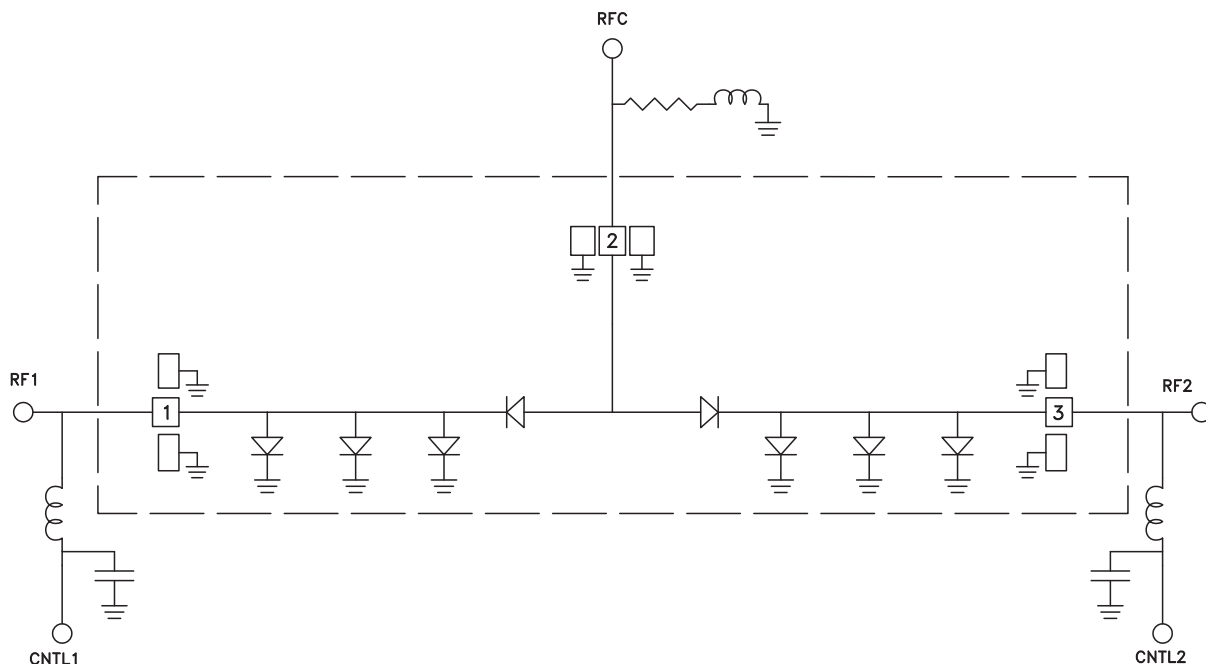

Information furnished by Analog Devices is believed to be accurate and reliable. However, no responsibility is assumed by Analog Devices for its use, nor for any infringements of patents or other rights of third parties that may result from its use. Specifications subject to change without notice. No license is granted by implication or otherwise under any patent or patent rights of Analog Devices. Trademarks and registered trademarks are the property of their respective owners.

For price, delivery, and to place orders: Analog Devices, Inc., One Technology Way, P.O. Box 9106, Norwood, MA 02062-9106
Phone: 781-329-4700 • Order online at www.analog.com
Application Support: Phone: 1-800-ANALOG-D

PIN MMIC HIGH ISOLATION SPDT SWITCH, 2 - 50 GHz

Outline Drawing

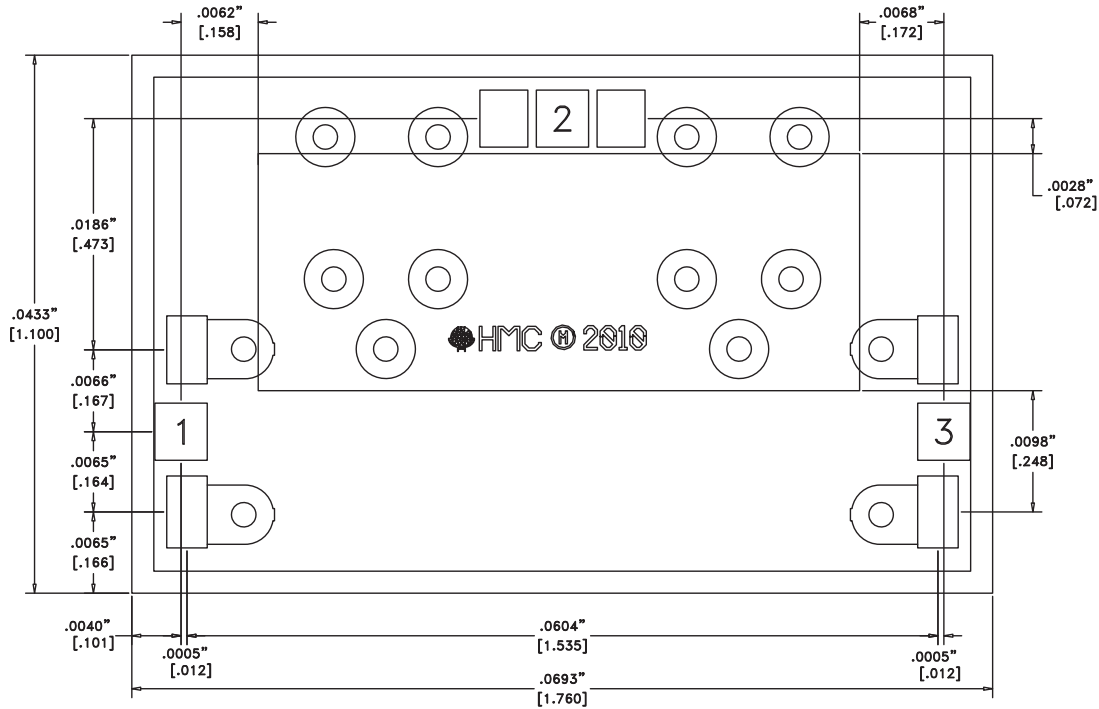

Die Packaging Information [1]

Standard	Alternate
GP-2 (Gel Pack)	[2]

[1] Refer to the "Packaging Information" section for die packaging dimensions.

[2] For alternate packaging information contact Hittite Microwave Corporation.

NOTES:

1. ALL DIMENSIONS ARE IN INCHES [MM]
2. DIE THICKNESS IS .004"
3. TYPICAL BOND PAD IS .004" SQUARE
4. BACKSIDE METALIZATION: GOLD
5. BACKSIDE METAL IS GROUND
6. BOND PAD METALIZATION: GOLD
7. NO CONNECTION REQUIRED FOR UNLABELED BOND PADS.
8. OVERALL DIE SIZE ±.002"

Pad Descriptions

Pad Number	Function	Description	Interface Schematic
1	RF1	RF output signal (path1). External DC bias through RF choke is required.	RF1
2	RFC	RF input signal. External dropping resistor to ground through the RF choke is required.	RFC
3	RF2	RF output signal (path2). External DC bias through RF choke is required.	RF2
Die Bottom	GND	Die bottom must be connected to RF/DC ground.	GND

Information furnished by Analog Devices is believed to be accurate and reliable. However, no responsibility is assumed by Analog Devices for its use, nor for any infringements of patents or other rights of third parties that may result from its use. Specifications subject to change without notice. No license is granted by implication or otherwise under any patent or patent rights of Analog Devices. Trademarks and registered trademarks are the property of their respective owners.

For price, delivery, and to place orders: Analog Devices, Inc., One Technology Way, P.O. Box 9106, Norwood, MA 02062-9106 Phone: 781-329-4700 • Order online at www.analog.com Application Support: Phone: 1-800-ANALOG-D

**PIN MMIC HIGH ISOLATION
SPDT SWITCH, 2 - 50 GHz**

Assembly Diagram

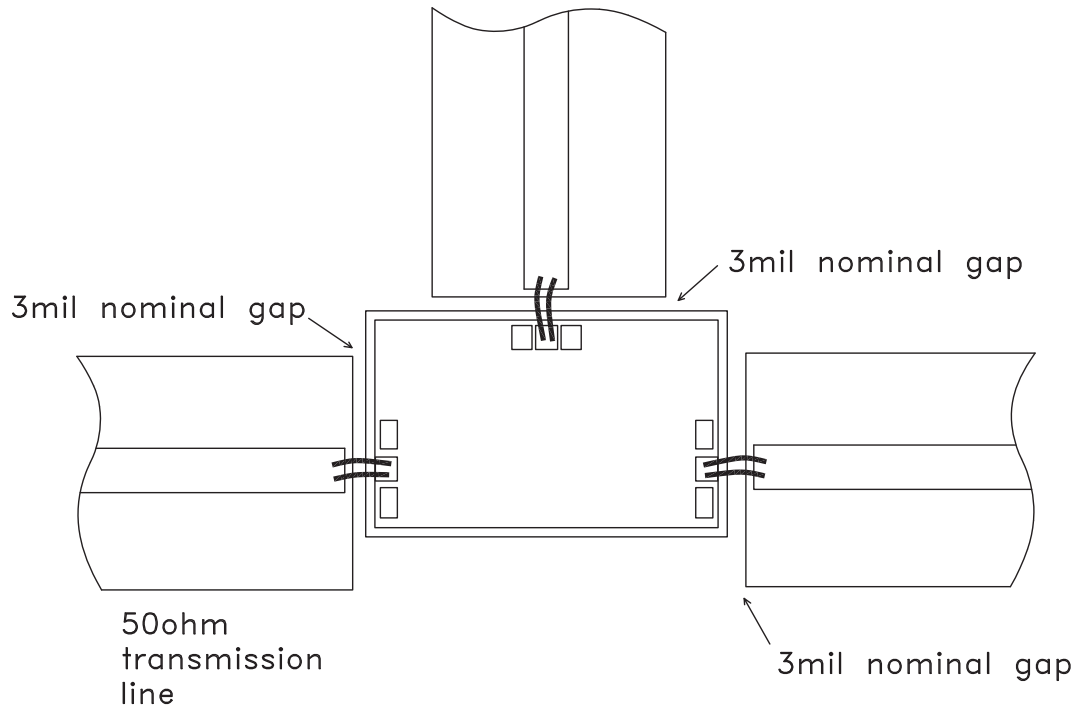

Information furnished by Analog Devices is believed to be accurate and reliable. However, no responsibility is assumed by Analog Devices for its use, nor for any infringements of patents or other rights of third parties that may result from its use. Specifications subject to change without notice. No license is granted by implication or otherwise under any patent or patent rights of Analog Devices. Trademarks and registered trademarks are the property of their respective owners.

For price, delivery, and to place orders: Analog Devices, Inc., One Technology Way, P.O. Box 9106, Norwood, MA 02062-9106 Phone: 781-329-4700 • Order online at www.analog.com Application Support: Phone: 1-800-ANALOG-D

PIN MMIC HIGH ISOLATION SPDT SWITCH, 2 - 50 GHz

Mounting & Bonding Techniques for Millimeterwave GaAs MMICs

The die should be attached directly to the ground plane eutectically or with conductive epoxy (see HMC general Handling, Mounting, Bonding Note).

50 Ohm Microstrip transmission lines on 0.127mm (5 mil) thick alumina thin film substrates are recommended for bringing RF to and from the chip (Figure 1). If 0.254mm (10 mil) thick alumina thin film substrates must be used, the die should be raised 0.150mm (6 mils) so that the surface of the die is coplanar with the surface of the substrate. One way to accomplish this is to attach the 0.102mm (4 mil) thick die to a 0.150mm (6 mil) thick molybdenum heat spreader (moly-tab) which is then attached to the ground plane (Figure 2).

Microstrip substrates should be brought as close to the die as possible in order to minimize bond wire length. Typical die-to-substrate spacing is 0.076mm (3 mils).

Handling Precautions

Follow these precautions to avoid permanent damage.

Storage: All bare die are placed in either Waffle or Gel based ESD protective containers, and then sealed in an ESD protective bag for shipment. Once the sealed ESD protective bag has been opened, all die should be stored in a dry nitrogen environment.

Cleanliness: Handle the chips in a clean environment. DO NOT attempt to clean the chip using liquid cleaning systems.

Static Sensitivity: Follow ESD precautions to protect against ESD strikes.

Transients: Suppress instrument and bias supply transients while bias is applied. Use shielded signal and bias cables to minimize inductive pick-up.

General Handling: Handle the chip along the edges with a vacuum collet or with a sharp pair of bent tweezers. The surface of the chip has fragile air bridges and should not be touched with vacuum collet, tweezers, or fingers.

Mounting

The chip is back-metallized and can be die mounted with AuSn eutectic preforms or with electrically conductive epoxy. The mounting surface should be clean and flat.

Epoxy Die Attach: Apply a minimum amount of epoxy to the mounting surface so that a thin epoxy fillet is observed around the perimeter of the chip once it is placed into position. Cure epoxy per the manufacturer's schedule.

Wire Bonding

Ball or wedge bond with 0.025 mm (1 mil) diameter pure gold wire (DC bias, IF1 and IF2) or Ribbon Bond (RF and LO ports) 0.076 mm x 0.013 mm (3 mil x 0.5 mil) size is recommended. Thermosonic wirebonding with a nominal stage temperature of 150 °C and a ball bonding force of 40 to 50 grams or wedge bonding force of 18 to 22 grams is recommended. Use the minimum level of ultrasonic energy to achieve reliable wirebonds. Wirebonds should be started on the chip and terminated on the package or substrate. All bonds should be as short as possible <0.31 mm (12 mils).

