

## GaAs MMIC ANALOG VARIABLE GAIN AMPLIFIER, 0.5 - 6.0 GHz



### Typical Applications

The HMC972LP5E is ideal for:

- Cellular/3G Infrastructure
- WiBro / WiMAX / 4G
- Microwave Radio & VSAT
- Test Equipment and Sensors
- IF & RF Applications

### Features

- Wide Gain Control Range: -35 to +15 dB
- High Output IP3: +28 dBm
- Positive Analog Control: 0 to +5V
- Can be configured with 1 or 2 Attenuators
- 32 Lead 5x5 mm SMT Package: 25 mm<sup>2</sup>

### Functional Diagram

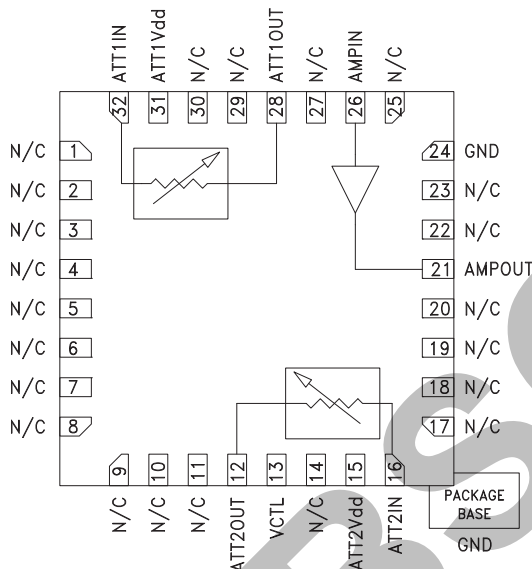

### General Description

The HMC972LP5E is an analog controlled variable gain amplifier composed of two identical voltage variable attenuators in combination with an InGaP HBT gain block MMIC amplifier which operates from 0.5 to 6 GHz, and can be controlled to provide anywhere from 15 dB of gain to 35 dB of attenuation. The HMC972LP5E delivers noise figure of 7.5 dB in its maximum gain state, with output IP3 of up to +28 dBm. The HMC972LP5E is housed in a RoHS compliant 5x5 mm QFN leadless package, and requires no external matching components.

### Electrical Specifications, $T_A = +25^\circ\text{C}$ , 50 Ohm System, $V_{dd} = \text{ATT1Vdd} = \text{ATT2Vdd} = +5\text{V}$ [1]

Parameter	Frequency	Min.	Typ.	Max.	Units
Insertion Gain (Vctl = 0V)	0.5 - 2.7 GHz	10.5	13		dB
	2.7 - 4.0 GHz	6	9		dB
	4.0 - 6.0 GHz		0		
Gain Control Range	0.5 - 4.0 GHz		50		dB
	4.0 - 6.0 GHz		42		
Input Return Loss (Vctl = 0V)			12		dB
Output Return Loss (Vctl = 0V)			10		dB
Output Power for 1dB Compression (Vctl = 0V)	0.5 - 2.7 GHz		16		dBm
	2.7 - 4.0 GHz		13		dBm
	4.0 - 6.0 GHz		6		
Output Third Order Intercept Point (Two-Tone Output Power = 0 dBm Each Tone) (Vctl = 0V)	0.5 - 2.7 GHz		29		dBm
	2.7 - 4.0 GHz		26		dBm
	4.0 - 6.0 GHz		20		
Noise Figure (Vctl = 0V)			7.5		dB
I <sub>dd</sub>		75	85	102	mA
ATT1I <sub>dd</sub>			0.2	0.3	mA
ATT2I <sub>dd</sub>			0.2	0.3	mA

[1] Unless otherwise noted, test conditions: ATT1 + AMP + ATT2 in cascade.

Information furnished by Analog Devices is believed to be accurate and reliable. However, no responsibility is assumed by Analog Devices for its use, nor for any infringements of patents or other rights of third parties that may result from its use. Specifications subject to change without notice. No license is granted by implication or otherwise under any patent or patent rights of Analog Devices. Trademarks and registered trademarks are the property of their respective owners.

For price, delivery, and to place orders: Analog Devices, Inc., One Technology Way, P.O. Box 9106, Norwood, MA 02062-9106  
 Phone: 781-329-4700 • Order online at [www.analog.com](http://www.analog.com)  
 Application Support: Phone: 1-800-ANALOG-D



**GaAs MMIC ANALOG VARIABLE GAIN AMPLIFIER, 0.5 - 6.0 GHz**

**Gain vs. Frequency Over Vctl [1]**

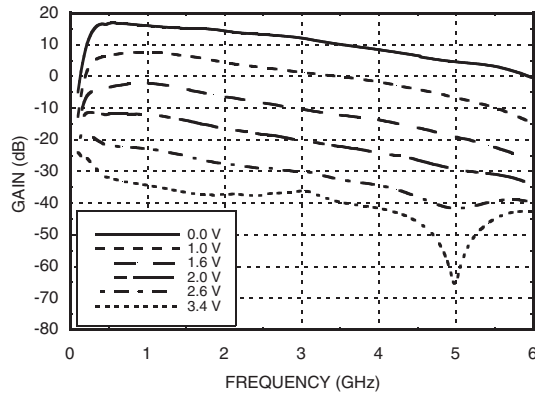

**Gain Over Temperature (Vctl = 0V) [1]**

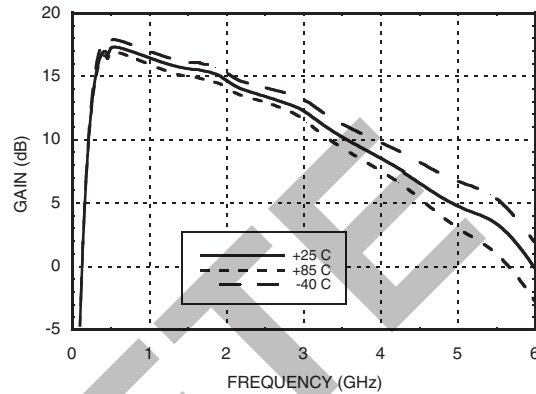

**Gain vs. Vctl Over Temperature @ 0.5 GHz [1]**

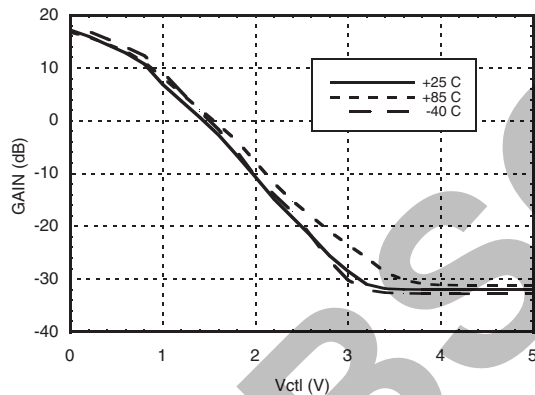

**Gain vs. Vctl Over Temperature @ 2 GHz [1]**

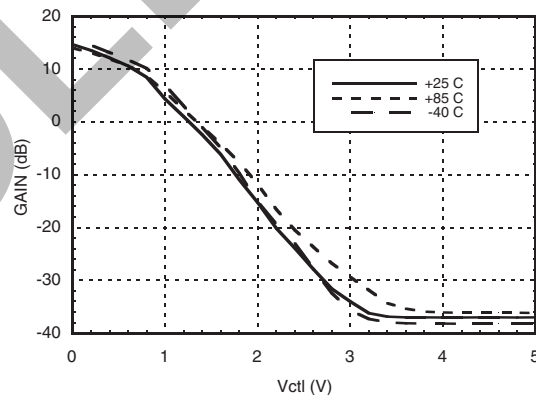

**Gain vs. Vctl Over Temperature @ 4 GHz [1]**

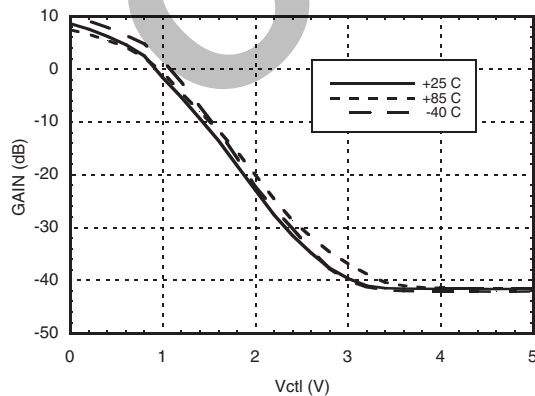

**Gain vs. Vctl Over Temperature @ 6 GHz [1]**

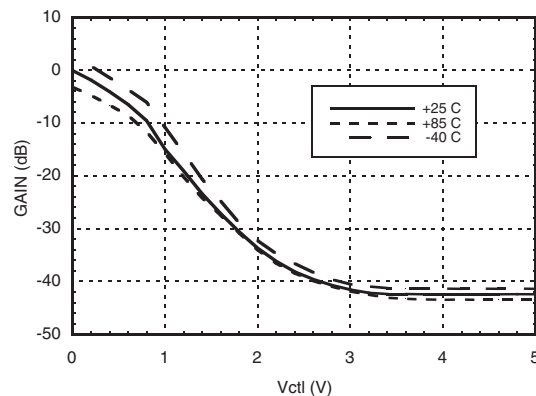

[1] ATT1 + AMP + ATT2

Information furnished by Analog Devices is believed to be accurate and reliable. However, no responsibility is assumed by Analog Devices for its use, nor for any infringements of patents or other rights of third parties that may result from its use. Specifications subject to change without notice. No license is granted by implication or otherwise under any patent or patent rights of Analog Devices. Trademarks and registered trademarks are the property of their respective owners.

For price, delivery, and to place orders: Analog Devices, Inc., One Technology Way, P.O. Box 9106, Norwood, MA 02062-9106 Phone: 781-329-4700 • Order online at [www.analog.com](http://www.analog.com) Application Support: Phone: 1-800-ANALOG-D



**GaAs MMIC ANALOG VARIABLE GAIN AMPLIFIER, 0.5 - 6.0 GHz**

**Input Return Loss Over Vctl [1]**

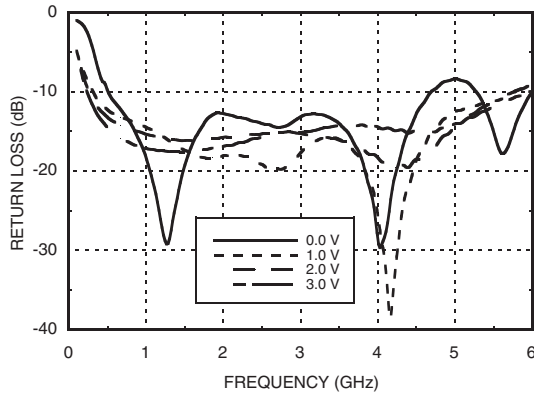

**Input Return Loss Over Temperature (Vctl = 0V) [1]**

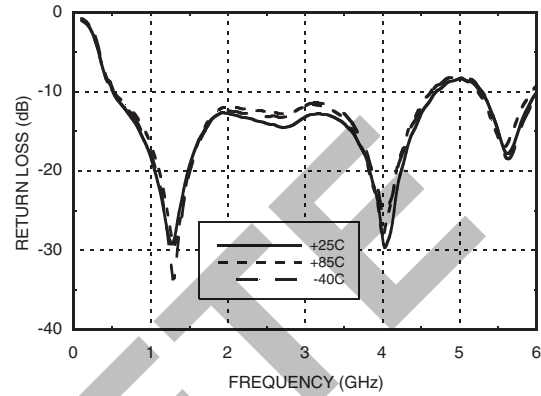

**Output Return Loss Over Vctl [1]**

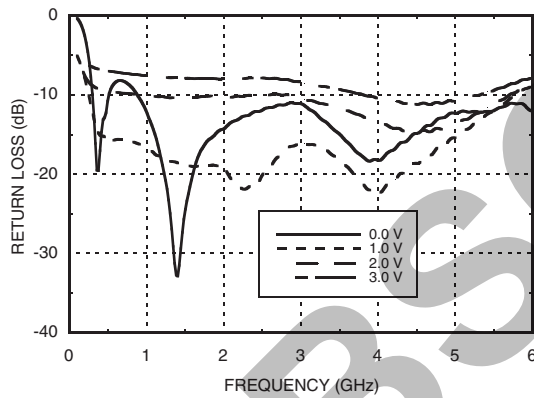

**Output Return Loss Over Temperature (Vctl = 0V) [1]**

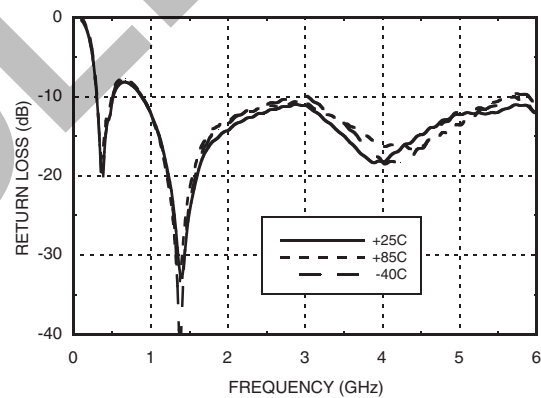

**Output IP3 vs. Vctl [1]**

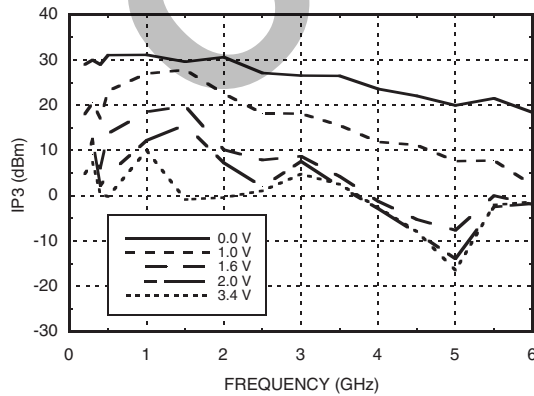

**Output IP3 vs. Temperature (Vctl = 0V) [1]**

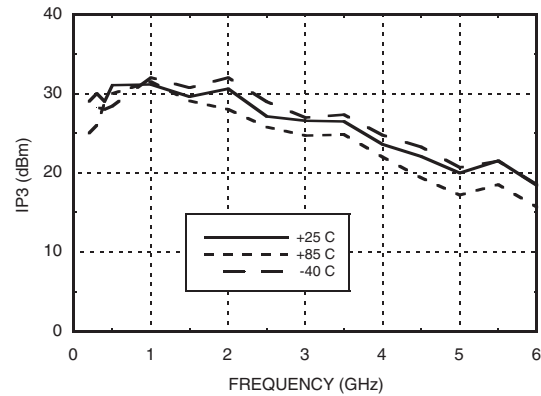

[1] ATT1 + AMP + ATT2

Information furnished by Analog Devices is believed to be accurate and reliable. However, no responsibility is assumed by Analog Devices for its use, nor for any infringements of patents or other rights of third parties that may result from its use. Specifications subject to change without notice. No license is granted by implication or otherwise under any patent or patent rights of Analog Devices. Trademarks and registered trademarks are the property of their respective owners.

For price, delivery, and to place orders: Analog Devices, Inc., One Technology Way, P.O. Box 9106, Norwood, MA 02062-9106 Phone: 781-329-4700 • Order online at [www.analog.com](http://www.analog.com) Application Support: Phone: 1-800-ANALOG-D



**GaAs MMIC ANALOG VARIABLE  
GAIN AMPLIFIER, 0.5 - 6.0 GHz**

**Output IP2 vs. Vctl [1]**

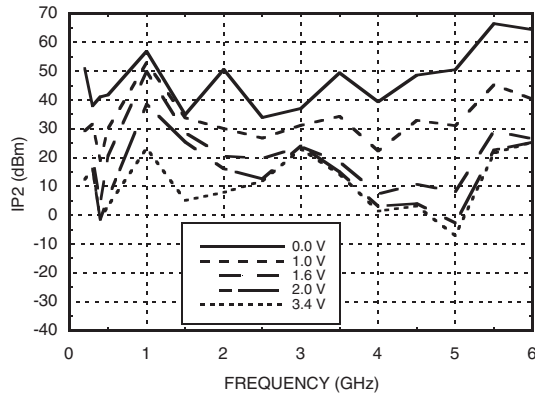

**Output IP2 vs. Temperature (Vctl = 0V) [1]**

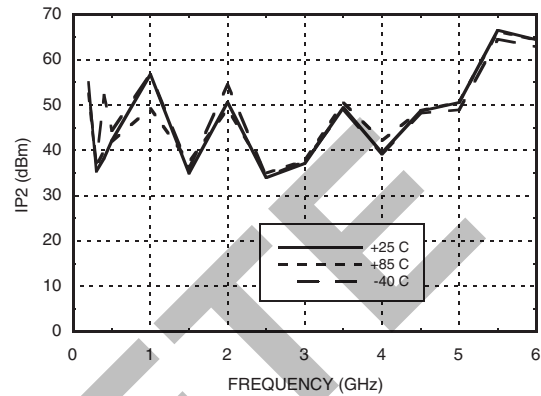

**Noise Figure Over Temperature  
(Vctl = 0V) [1]**

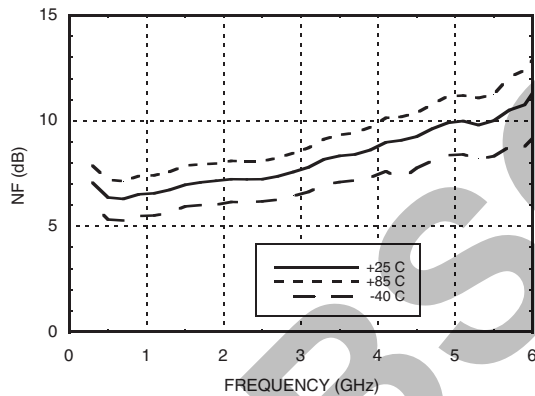

**Output P1dB Over Temperature  
(Vctl = 0V) [1]**

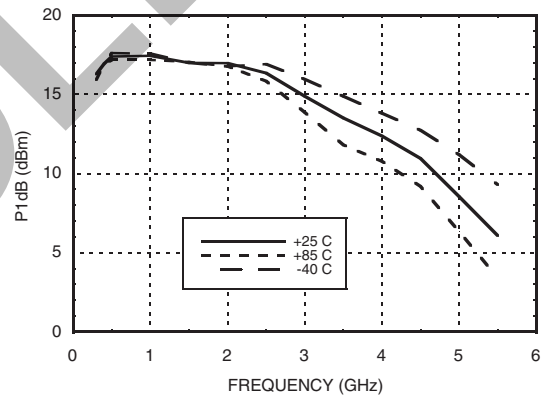

[1] ATT1 + AMP + ATT2

Information furnished by Analog Devices is believed to be accurate and reliable. However, no responsibility is assumed by Analog Devices for its use, nor for any infringements of patents or other rights of third parties that may result from its use. Specifications subject to change without notice. No license is granted by implication or otherwise under any patent or patent rights of Analog Devices. Trademarks and registered trademarks are the property of their respective owners.

For price, delivery, and to place orders: Analog Devices, Inc., One Technology Way, P.O. Box 9106, Norwood, MA 02062-9106 Phone: 781-329-4700 • Order online at [www.analog.com](http://www.analog.com) Application Support: Phone: 1-800-ANALOG-D



**GaAs MMIC ANALOG VARIABLE GAIN AMPLIFIER, 0.5 - 6.0 GHz**

**Insertion Loss vs. Vctl [2]**

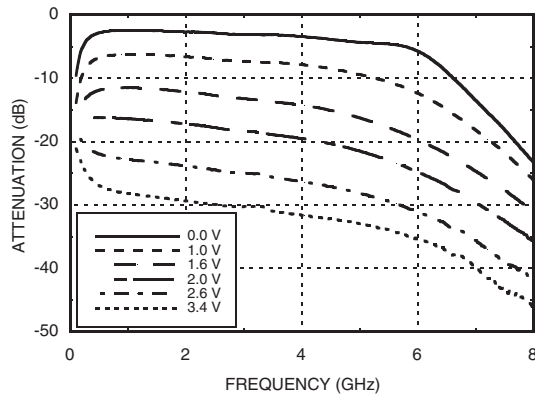

**Insertion Loss vs. Temperature [2]**

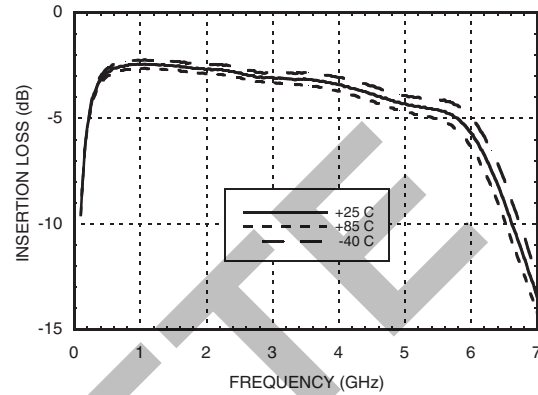

**Input Return Loss vs. Vctl [2]**

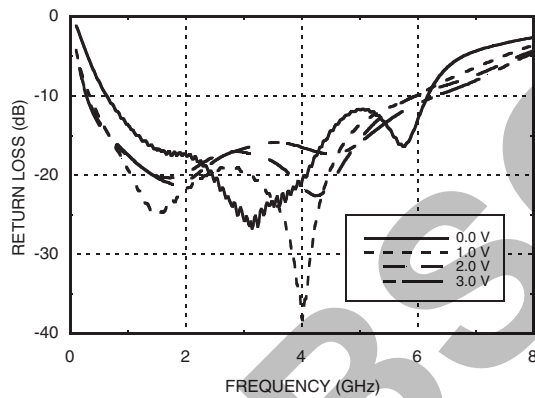

**Output Return Loss vs. Vctl [2]**

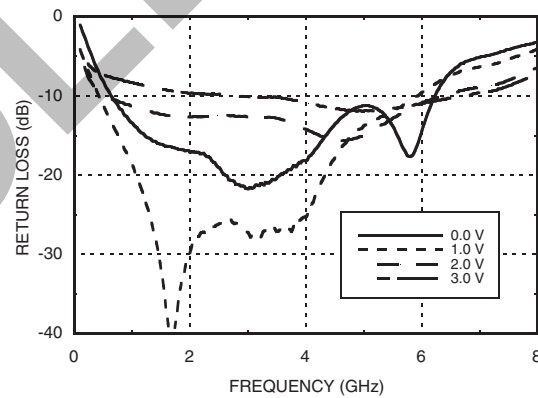

**Input IP3 vs. Vctl [2]**

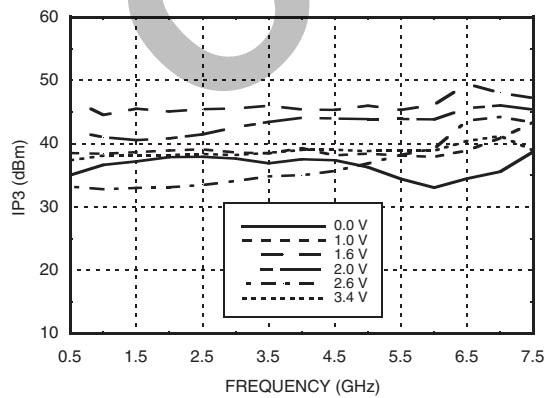

**Input IP3 vs. Temperature (Vctl = 0V) [2]**

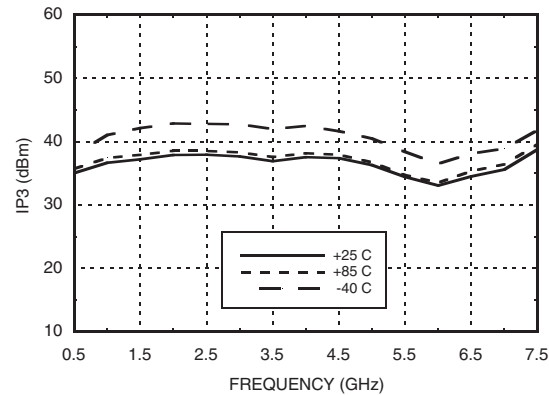

[2] ATT1 Only

Information furnished by Analog Devices is believed to be accurate and reliable. However, no responsibility is assumed by Analog Devices for its use, nor for any infringements of patents or other rights of third parties that may result from its use. Specifications subject to change without notice. No license is granted by implication or otherwise under any patent or patent rights of Analog Devices. Trademarks and registered trademarks are the property of their respective owners.

For price, delivery, and to place orders: Analog Devices, Inc., One Technology Way, P.O. Box 9106, Norwood, MA 02062-9106 Phone: 781-329-4700 • Order online at [www.analog.com](http://www.analog.com) Application Support: Phone: 1-800-ANALOG-D



## GaAs MMIC ANALOG VARIABLE GAIN AMPLIFIER, 0.5 - 6.0 GHz

### Absolute Maximum Ratings

RF Input Power	+12 dBm
Supply Voltage	5.5 Vdc
Channel Temperature	150 °C
Continuous Pdiss (T = 85 °C) (derate 8.5 mW/°C above 85 °C) [1]	0.55 W
Thermal Resistance (Junction to Exposed Ground Paddle)	120 °C/W
Storage Temperature	-65 to +150 °C
Operating Temperature	-40 to +85 °C
ESD Sensitivity (HBM)	Class 1A

### Bias Voltage

Vdd (V)	Idd (Typ.) (mA)
+5V	90



ELECTROSTATIC SENSITIVE DEVICE  
OBSERVE HANDLING PRECAUTIONS

### Outline Drawing

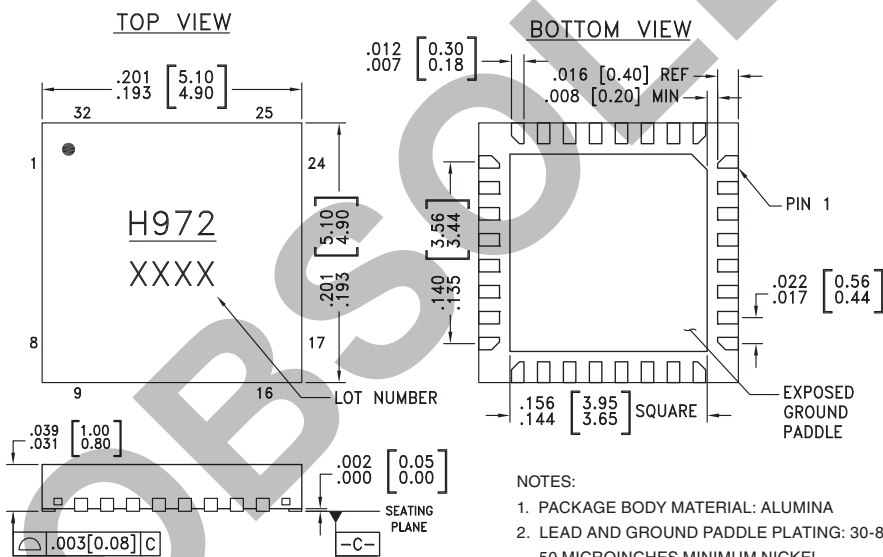

NOTES:

1. PACKAGE BODY MATERIAL: ALUMINA
2. LEAD AND GROUND PADDLE PLATING: 30-80 MICROINCHES GOLD OVER 50 MICROINCHES MINIMUM NICKEL.
3. DIMENSIONS ARE IN INCHES [MILLIMETERS].
4. LEAD SPACING TOLERANCE IS NON-CUMULATIVE
5. PACKAGE WARP SHALL NOT EXCEED 0.05mm DATUM [-C-]
6. ALL GROUND LEADS AND GROUND PADDLE MUST BE SOLDERED TO PCB RF GROUND.
7. CLASSIFIED AS MOISTURE SENSITIVITY LEVEL (MSL) 1.

### Package Information

Part Number	Package Body Material	Lead Finish	MSL Rating	Package Marking [1]
HMC972LP5E	RoHS-compliant Low Stress Injection Molded Plastic	100% matte Sn	MSL1 [2]	H972 XXXX



[1] 4-Digit lot number XXXX

[2] Max peak reflow temperature of 260 °C

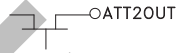
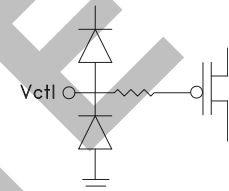
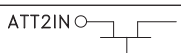
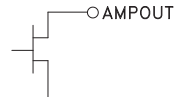

## GaAs MMIC ANALOG VARIABLE GAIN AMPLIFIER, 0.5 - 6.0 GHz

### Pin Descriptions

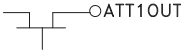
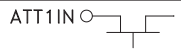
Pin Number	Function	Description	Interface Schematic
1 - 11, 14, 17 - 20, 22, 23, 25, 27, 29, 30	N/C	No connection required. The pins are not connected internally; however, all data shown herein was measured with these pins connected to RF/DC ground externally.	
12	ATT2OUT	This port is matched to 50 Ohms. Blocking capacitor required.	
13	Vctl	Attenuation control voltage for the attenuators. 0V for minimum attenuation, 5V for maximum attenuation.	
15	ATT2VDD	Power Supply for attenuator 2. External bypass capacitor is required. See application circuit.	
16	ATT2IN	This port is matched to 50 Ohms. Blocking capacitor required. Attenuator performance is similar to HMC973LP3E.	
21	AMPOUT	This port is matched to 50 Ohms. External Choke inductor and DC blocking capacitor are required. See application circuit.	
24	GND	This pin and the exposed ground paddle must be connected to RF/DC ground.	
26	AMPIN	This port is matched to 50 Ohms. Blocking capacitor required. Amplifier performance is similar to HMC589ST89E.	
28	ATT1OUT	This port is matched to 50 Ohms. Blocking capacitor required.	
31	ATT1VDD	Power supply for attenuator 1. External bias capacitor is required. See application circuit.	
32	ATT1IN	This port is matched to 50 Ohms. Blocking capacitor required. Attenuator performance is similar to HMC973LP3E.	

13

VARIABLE GAIN AMPLIFIERS - ANALOG - SMT



**GaAs MMIC ANALOG VARIABLE GAIN AMPLIFIER, 0.5 - 6.0 GHz**

**Application Circuit**

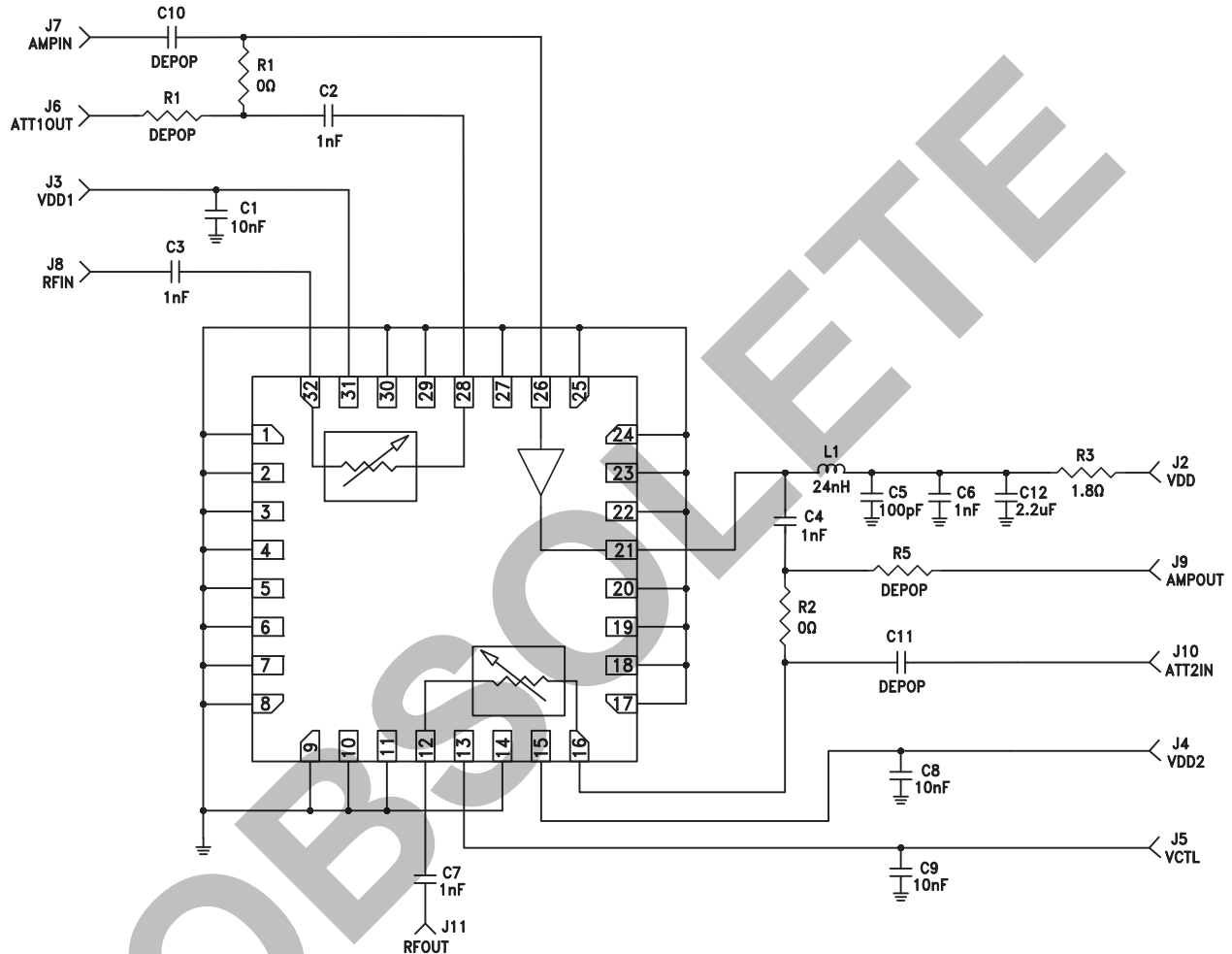

13

VARIABLE GAIN AMPLIFIERS - ANALOG - SMT

Information furnished by Analog Devices is believed to be accurate and reliable. However, no responsibility is assumed by Analog Devices for its use, nor for any infringements of patents or other rights of third parties that may result from its use. Specifications subject to change without notice. No license is granted by implication or otherwise under any patent or patent rights of Analog Devices. Trademarks and registered trademarks are the property of their respective owners.

For price, delivery, and to place orders: Analog Devices, Inc., One Technology Way, P.O. Box 9106, Norwood, MA 02062-9106 Phone: 781-329-4700 • Order online at [www.analog.com](http://www.analog.com) Application Support: Phone: 1-800-ANALOG-D





**GaAs MMIC ANALOG VARIABLE GAIN AMPLIFIER, 0.5 - 6.0 GHz**

**Evaluation PCB**

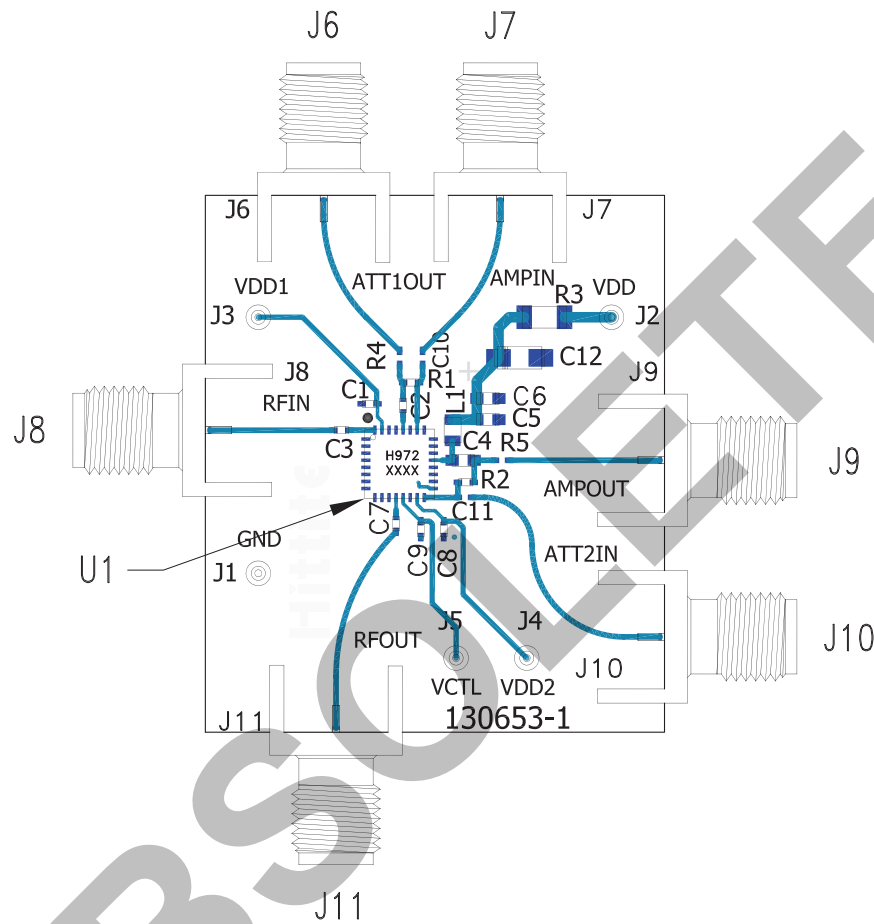

**List of Materials for Evaluation PCB 130656 [1]**

Item	Description
J1 - J5	DC Connector Header
J6 - J11	PCB Mount SMA RF Connector
C1, C8, C9	10 nF Capacitor, 0402 Pkg
C2, C3, C7	1000 pF Capacitor, 0402 Pkg.
C4, C6	1000 pF Capacitor, 0603 Pkg.
C5	100 pF Capacitor, 0603 Pkg.
C12	2.2 μF Capacitor, CASE A Pkg.
L1	24 nH Inductor 0603 Pkg.
R1, R2	0 Ohm Resistor, 0402 Pkg.
R3	1.8 Ohm Resistor, 1206 Pkg.
U1	HMC972LP5E Variable Gain Amplifier
PCB [2]	130653 Evaluation PCB

[1] Reference this number when ordering complete evaluation PCB

[2] Circuit Board Material: Rogers 4350

The circuit board used in the application should use RF circuit design techniques. Signal lines should have 50 Ohm impedance while the package ground leads and exposed paddle should be connected directly to the ground plane similar to that shown. A sufficient number of via holes should be used to connect the top and bottom ground planes. The evaluation circuit board shown is available from Hittite upon request.

Information furnished by Analog Devices is believed to be accurate and reliable. However, no responsibility is assumed by Analog Devices for its use, nor for any infringements of patents or other rights of third parties that may result from its use. Specifications subject to change without notice. No license is granted by implication or otherwise under any patent or patent rights of Analog Devices. Trademarks and registered trademarks are the property of their respective owners.

For price, delivery, and to place orders: Analog Devices, Inc., One Technology Way, P.O. Box 9106, Norwood, MA 02062-9106 Phone: 781-329-4700 • Order online at [www.analog.com](http://www.analog.com) Application Support: Phone: 1-800-ANALOG-D

**GaAs MMIC ANALOG VARIABLE  
GAIN AMPLIFIER, 0.5 - 6.0 GHz****Notes:**

OBSOLETE