

Analog Devices Welcomes Hittite Microwave Corporation

NO CONTENT ON THE ATTACHED DOCUMENT HAS CHANGED



THIS PAGE INTENTIONALLY LEFT BLANK

Typical Applications

The HMC869LC5 is ideal for:

- Point-to-Point and Point-to-Multi-Point Radio
- Military Radar, EW & ELINT
- Satellite Communications

Features

- Conversion Gain: 14 dB
- Image Rejection: 32 dB
- LO to RF Isolation: 45 dB
- Noise Figure: 2.8 dB
- Input IP3: -1 dBm
- 32 Lead 5x5mm SMT Ceramic Package: 25mm²

Functional Diagram

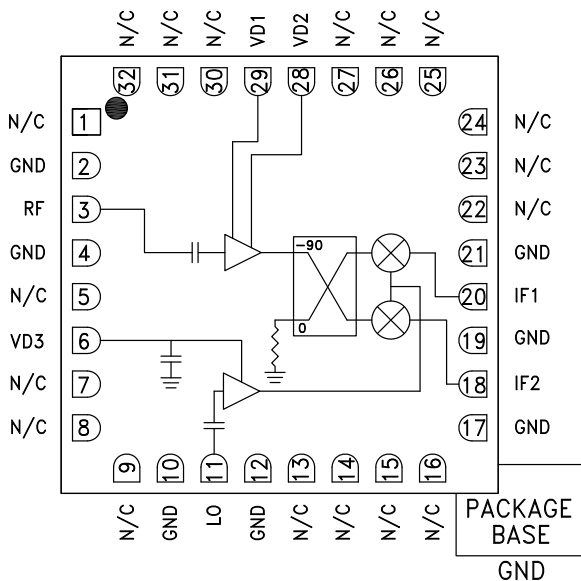

General Description

The HMC869LC5 is a GaAs MCM I/Q downconverter in a leadless RoHS compliant SMT package. This device provides a small signal conversion gain of 14 dB with a noise figure of 2.8 dB and 32 dB of image rejection. The HMC869LC5 utilizes an LNA followed by an image reject mixer which is driven by an LO buffer amplifier. The image reject mixer eliminates the need for a filter following the LNA, and removes thermal noise at the image frequency. I and Q mixer outputs are provided and an external 90° hybrid is needed to select the required sideband. The HMC869LC5 is a much smaller alternative to hybrid style image reject mixer downconverter assemblies, and it eliminates the need for wire bonding by allowing the use of surface mount manufacturing techniques.

Electrical Specifications, $T_A = +25^\circ\text{C}$, IF = 100 MHz, LO = +2 dBm, VD3 = 5V, VD1, VD2 = 3V*

Parameter	Min.	Typ.	Max.	Units
Frequency Range, RF		12 - 16		GHz
Frequency Range, LO		8.5 - 19.5		GHz
Frequency Range, IF		DC - 3.5		GHz
Conversion Gain (As IRM)	10	14		dB
Noise Figure		2.8		dB
Image Rejection	15	32		dB
1 dB Compression (Input)		-10		dBm
LO to RF Isolation	30	45		dB
LO to IF Isolation	20	32		dB
IP3 (Input)		-1		dBm
Amplitude Balance		0		dB
Phase Balance		±10		Deg
Supply Current (ID1 + ID2)		60	88	mA
Supply Current (ID3)		100	120	mA

*Data taken as IRM with external 90° IF Hybrid

Data Taken As IRM With External 90° IF Hybrid

Conversion Gain vs. Temperature

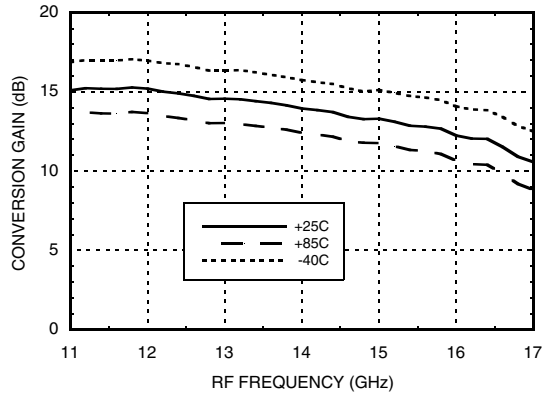
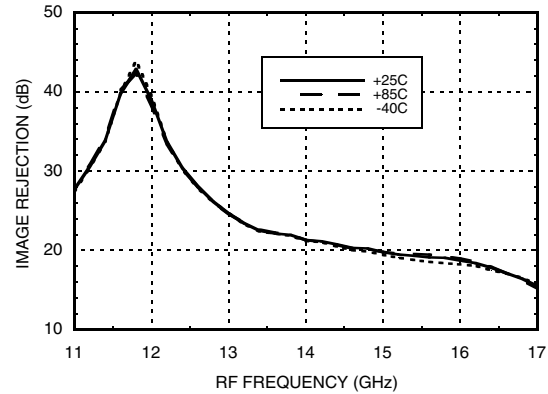
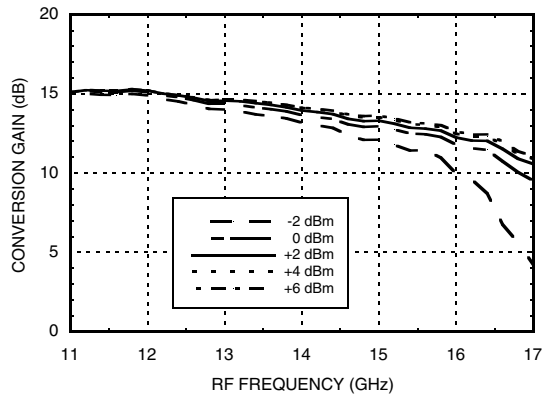

Image Rejection vs. Temperature



Conversion Gain vs. LO Drive



Return Loss

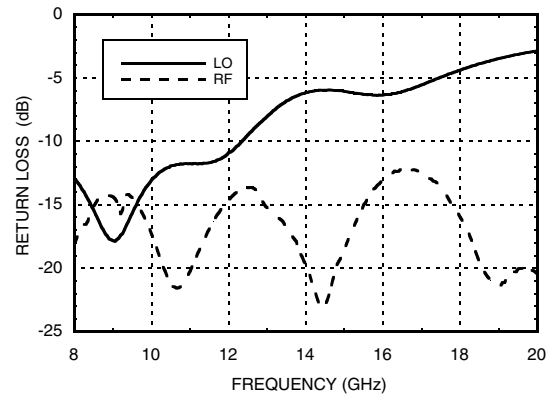

Input P1dB vs. Temperature

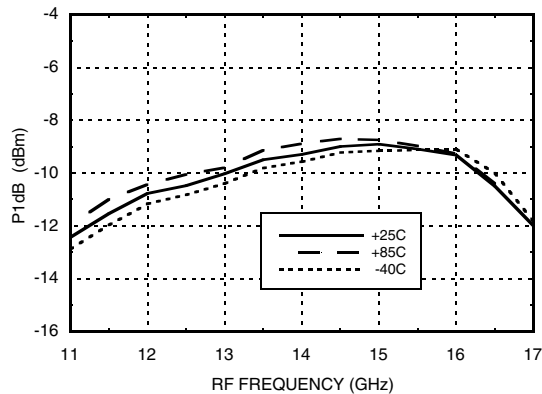

Input IP3 vs. LO Drive

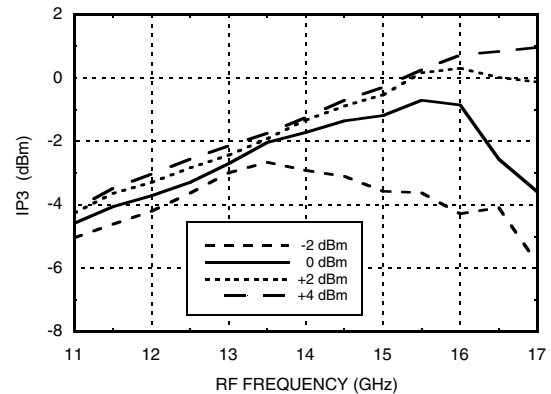



Quadrature Channel Data Taken Without IF Hybrid

Isolations

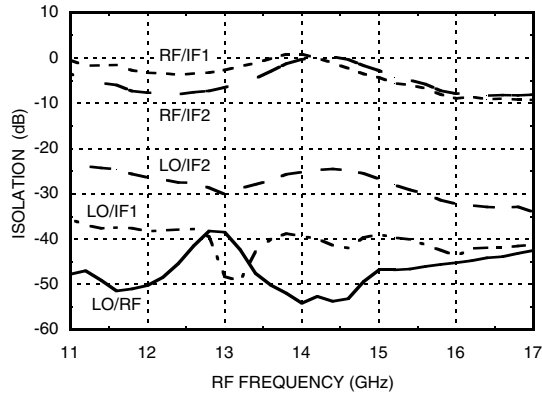

IF Bandwidth*

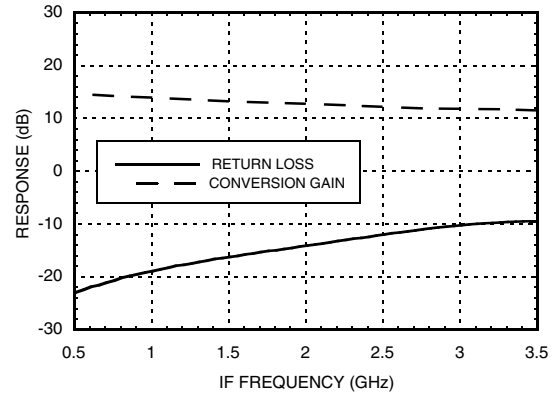

Amplitude Balance vs. LO Drive

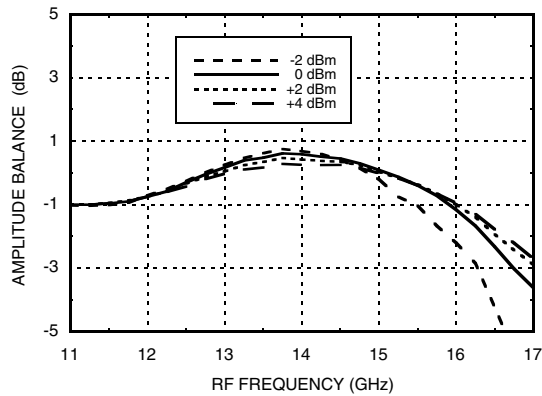

Phase Balance vs. LO Drive

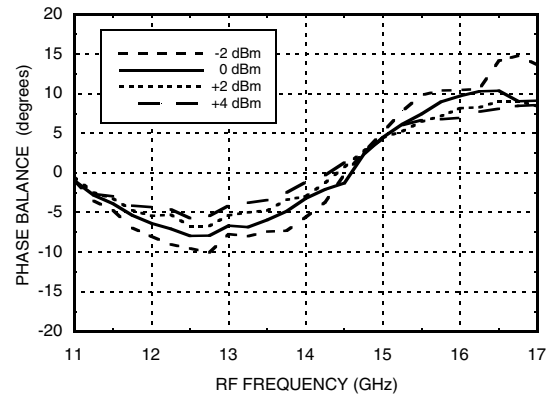

Noise Figure vs. LO Drive, LO Frequency = 12 GHz

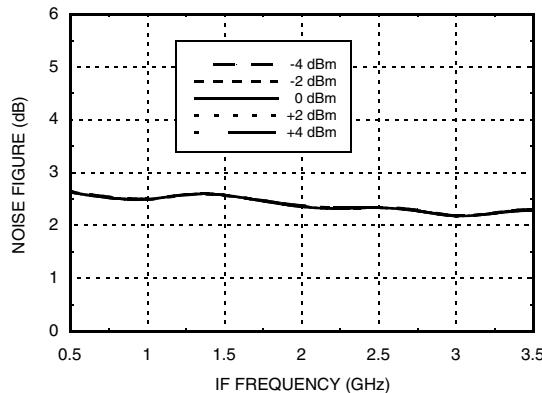

Noise Figure vs. LO Drive, IF Frequency = 100 MHz

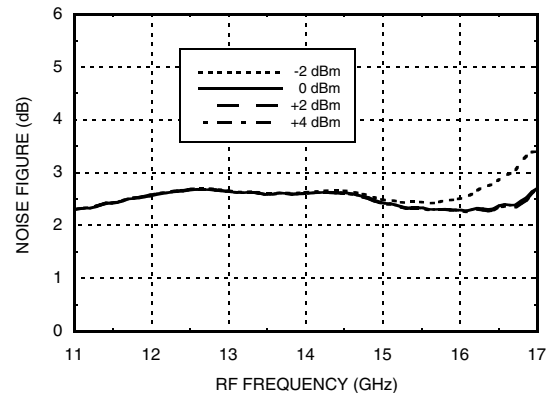

* Conversion gain data taken with external IF hybrid, LO frequency fixed at 12 GHz and RF varied

**GaAs MMIC I/Q DOWNCONVERTER
12 - 16 GHz**
MxN Spurious Outputs

mRF	nLO				
	0	1	2	3	4
0	xx	43	40	54	xx
1	22	xx	42	56	77
2	74	67	xx	74	98
3	99	97	73	xx	90
4	xx	104	120	102	xx

RF = 13.6 GHz @ -20 dBm

LO = 13.5 GHz @ +2 dBm

Data taken without IF hybrid

All values in dBc below IF power level.

Absolute Maximum Ratings

RF	+5 dBm
LO Drive	+20 dBm
VD1, VD2	4.0V
VD3	5.5V
Channel Temperature	150 °C
Continuous Pdiss (T=85°C) (derate 9.56 mW/°C above 85°C)	0.65 W
Thermal Resistance (R _{TH}) (channel to package bottom)	71 °C/W
Storage Temperature	-65 to +150 °C
Operating Temperature	-40 to +85 °C

**ELECTROSTATIC SENSITIVE DEVICE
OBSERVE HANDLING PRECAUTIONS**

Outline Drawing

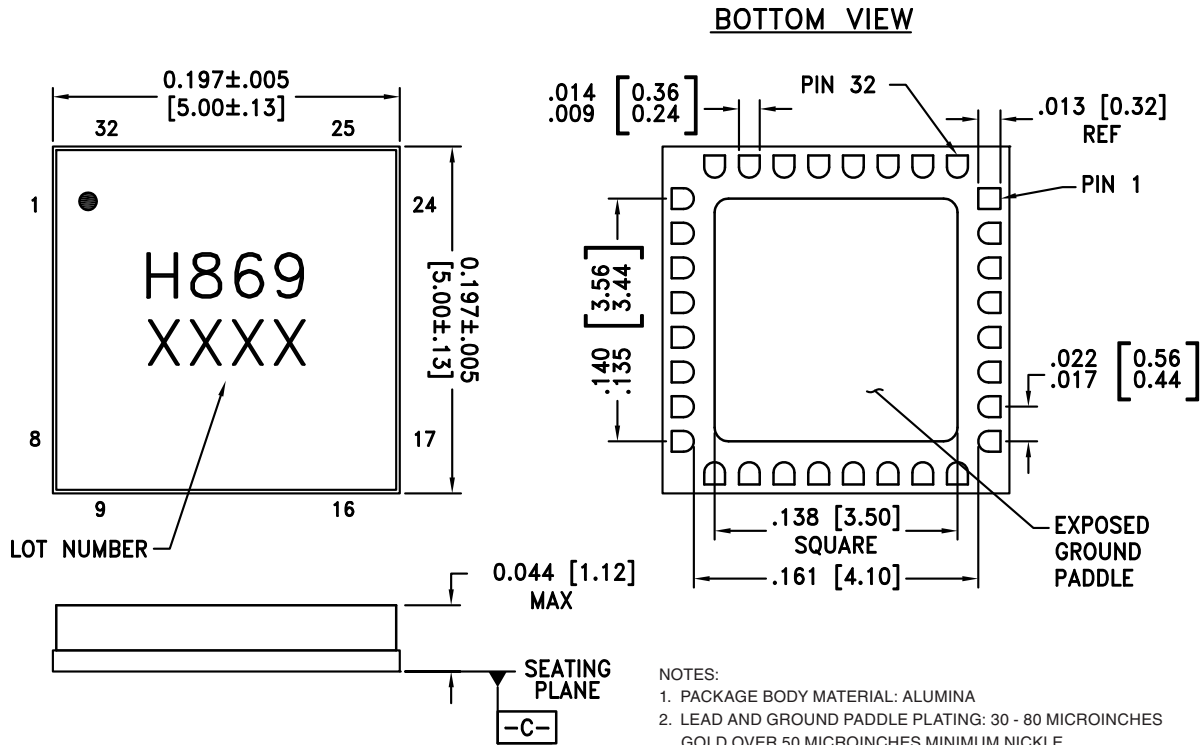

Package Information

Part Number	Package Body Material	Lead Finish	MSL Rating	Package Marking ^[2]
HMC869LC5	Alumina, White	Gold over Nickel	MSL3 ^[1]	H869 XXXX

[1] Max peak reflow temperature of 260 °C

[2] 4-Digit lot number XXXX

Pin Descriptions

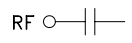
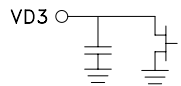
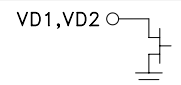
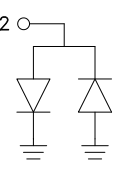
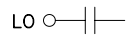
Pin Number	Function	Description	Interface Schematic
1, 5, 7 - 9, 13 - 16, 22 - 27, 30 - 32	N/C	The pins are not connected internally; however, all data shown herein was measured with these pins connected to RF/DC ground externally.	
2, 4, 10, 12, 17, 19, 21	GND	These pins and ground paddle must be connected to RF/DC ground.	
3	RF	This pin is AC coupled and matched to 50 Ohms.	
6	VD3	Power supply for LO amplifier.	
28, 29	VD2, VD1	Power supply for RF LNA.	
18	IF2	This pin is DC coupled for applications not requiring operation to DC. This port should be DC blocked externally using a series capacitor whose value has been chosen to pass the necessary frequency range. For operation to DC, this pin must not sink / source more than 3 mA of current or part non-function and possible failure will result.	
20	IF1		
11	LO	This pin is AC coupled and matched to 50 Ohms.	

Typical Application

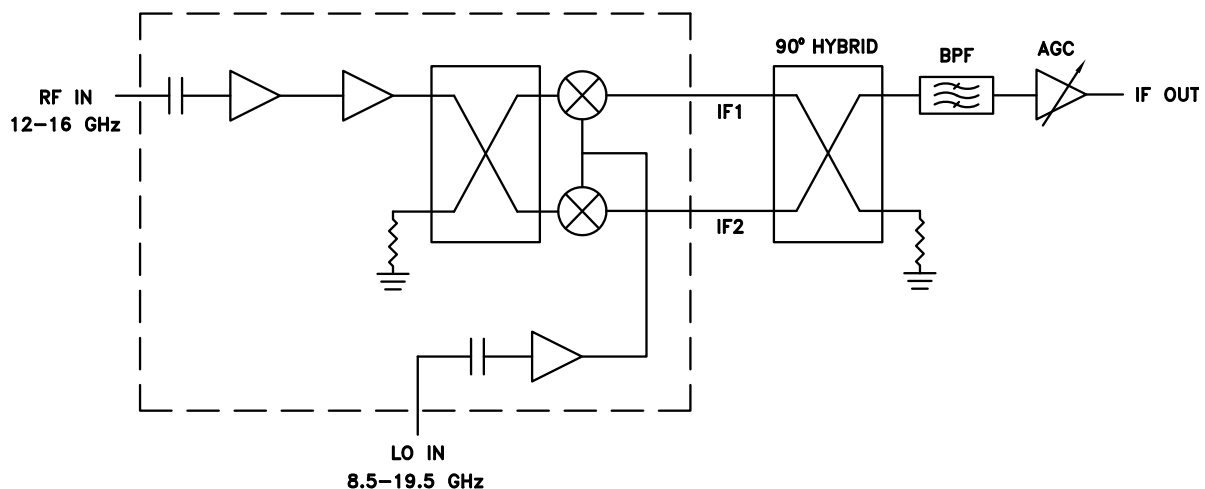

Note: LSB and USB is determined by GND on Hybrid

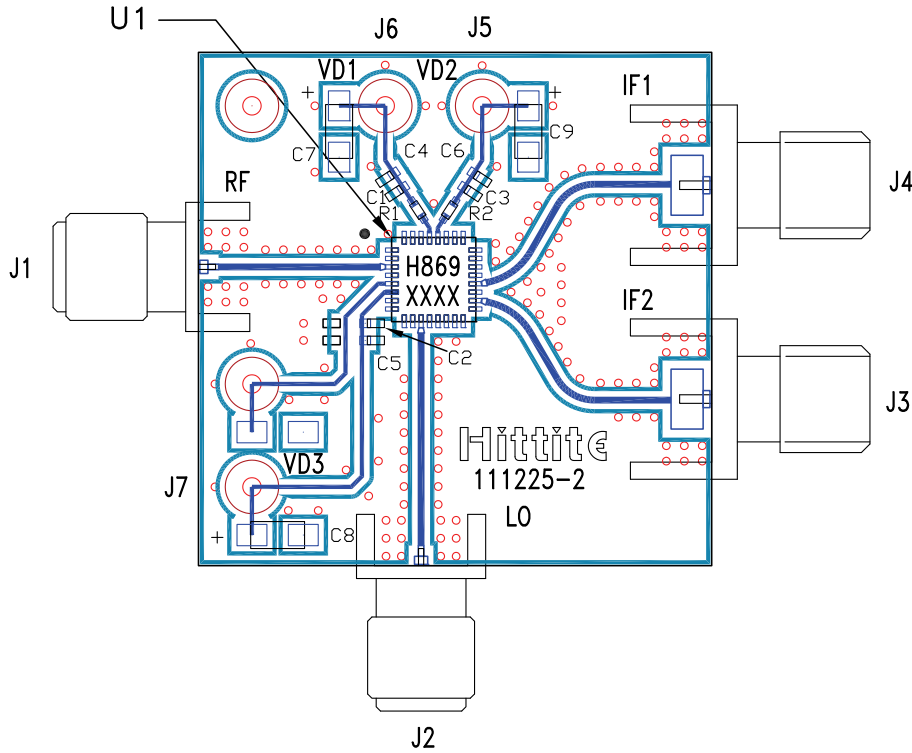
Evaluation PCB

List of Materials for Evaluation PCB 111227 [1]

Item	Description
J1, J2	PCB Mount SMA RF Connector, SRI
J3, J4	PCB Mount SMA Connector, Johnson
J5, J6, J7	DC Pin
C1, C2, C3	Capacitor 0402, Pkg. 100pF
C4, C5, C6	Capacitor 0402, Pkg. 1000pF
C7, C8, C9	Capacitor, Case A, 2.2uF
R1, R2	Resistor, 0402 Pkg. 0 Ohm
U1	HMC869LC5
PCB [2]	111225 Evaluation Board

[1] Reference this number when ordering complete evaluation PCB

[2] Circuit Board Material: Rogers 4350 or Arlon 25FR

The circuit board used in the final application should use RF circuit design techniques. Signal lines should have 50 Ohm impedance while the package ground leads and exposed paddle should be connected directly to the ground plane similar to that shown. A sufficient number of via holes should be used to connect the top and bottom ground planes. The evaluation circuit board shown is available from Hittite upon request.



MICROWAVE CORPORATION v01.0614



HMC869LC5

GaAs MMIC I/Q DOWNCONVERTER
12 - 16 GHz

MIXERS - I/Q MIXERS, IRMS & RECEIVERS - SMT