

Typical Applications

The HMC802LP3E is ideal for both RF and IF applications:

- Test Equipment and Sensors
- ISM, MMDS, WLAN, WiMAX, WiBro
- Microwave Radio & VSAT
- Cellular Infrastructure

Features

- ± 0.6 dB Typical Step Error
- Low Insertion Loss: 3 dB
- High IP3: +55 dBm
- Single Control Line
- TTL/CMOS Compatible Control
- Single +5V Supply
- 16 Lead 3x3mm SMT Package: 9mm²

Functional Diagram

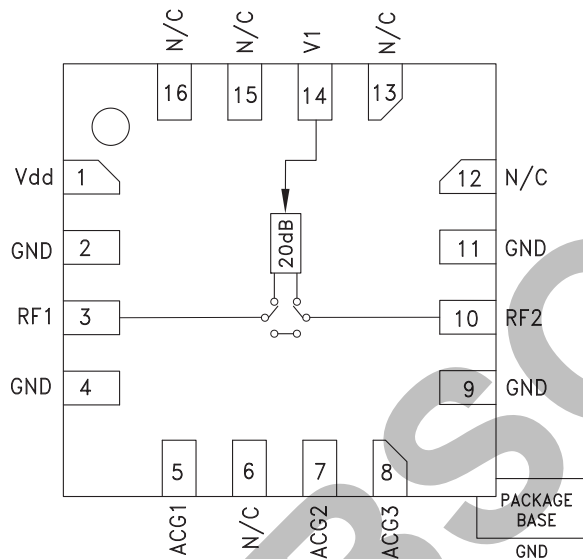

General Description

The HMC802LP3E is a broadband bidirectional 1-bit GaAs IC digital attenuator in a low cost leadless surface mount package. This single positive control line digital attenuator utilizes off chip AC ground capacitors for near DC operation, making it suitable for a wide variety of RF and IF applications. Covering DC to 10 GHz, the insertion loss is less than 3 dB typical and attenuation accuracy is excellent at ±0.6 dB typical. The attenuator also features a high IIP3 of +55 dBm. One TTL/CMOS control input is used to select the attenuation state and a single Vdd bias of +5V is required.

Electrical Specifications, $T_A = +25^\circ C$, With $V_{dd} = +5V$ & $V_{ctl} = 0/+5V$

Parameter	Frequency (GHz)	Min.	Typ.	Max.	Units
Insertion Loss	DC - 4 GHz		1.5	2.5	dB
	4 - 8 GHz		3.0	4.0	dB
	8 - 10 GHz		3.5	4.5	dB
Attenuation Range	DC - 10 GHz		20		dB
Return Loss (RF1 & RF2, Both States)	DC - 6 GHz		18		dB
	6 - 10 GHz		12		dB
Attenuation Accuracy: (Referenced to Insertion Loss)	DC - 8 GHz		± 0.4	± 0.6	dB
	8 - 10 GHz		± 0.8	± 1.2	dB
Input Power for 0.1 dB Compression	DC - 0.4 GHz		20		dBm
	0.4 - 10 GHz		30*		dBm
Input Third Order Intercept Point (Two-Tone Input Power= 0 dBm Each Tone)	DC - 0.4 GHz		45		dBm
	0.4 - 10 GHz		55		dBm
Switching Characteristics	DC - 10 GHz				
		tRISE, tFALL (10/90% RF)		120	ns
tON, tOFF (50% CTL to 10/90% RF)			150		ns

* For frequencies greater than 0.4 GHz, the 0.1 dB compression point is greater than the absolute maximum RF input power of 30 dBm.



20 dB GaAs MMIC 1-BIT DIGITAL POSITIVE CONTROL ATTENUATOR, DC - 10 GHz

Insertion Loss

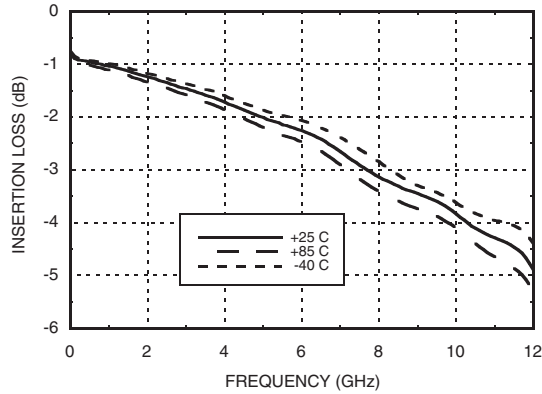

Input Return Loss

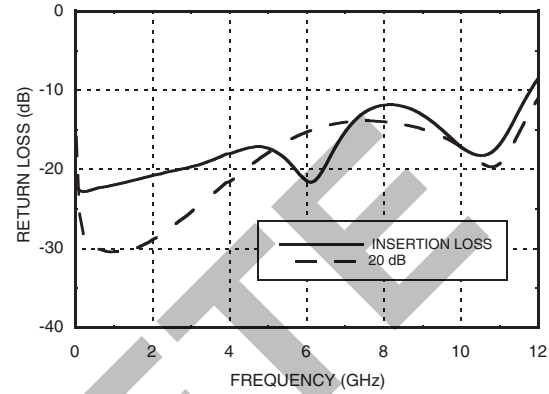

Output Return Loss

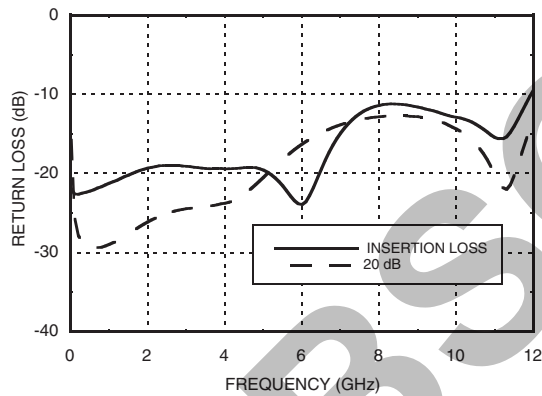

Relative Attenuation

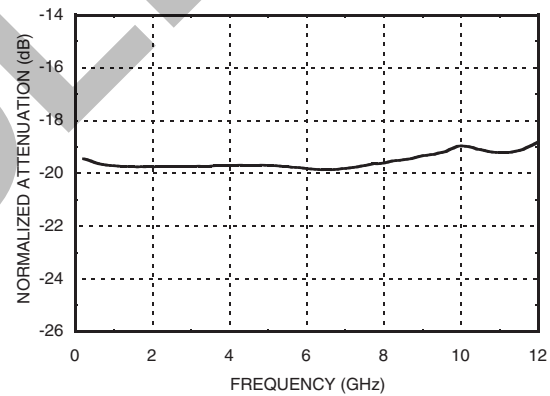

Relative Phase vs. Frequency

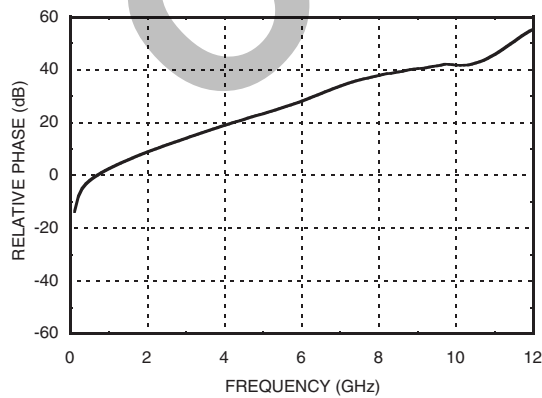

Bit Error vs. Frequency

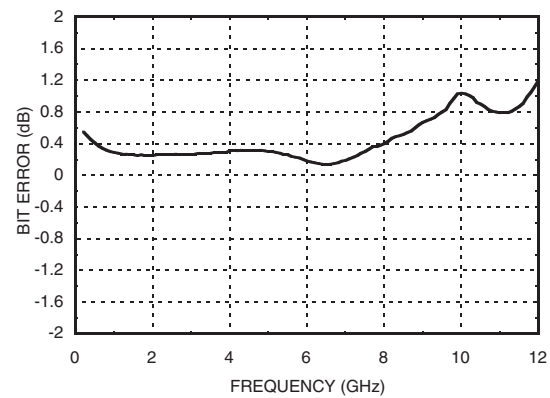



20 dB GaAs MMIC 1-BIT DIGITAL POSITIVE CONTROL ATTENUATOR, DC - 10 GHz

Input IP3 vs. Frequency

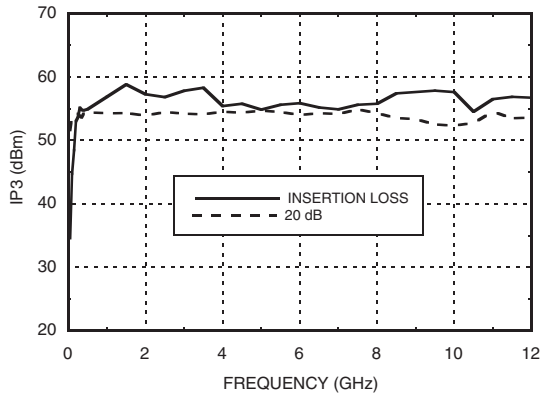

Input IP3 vs. Frequency (Low Frequency Detail)

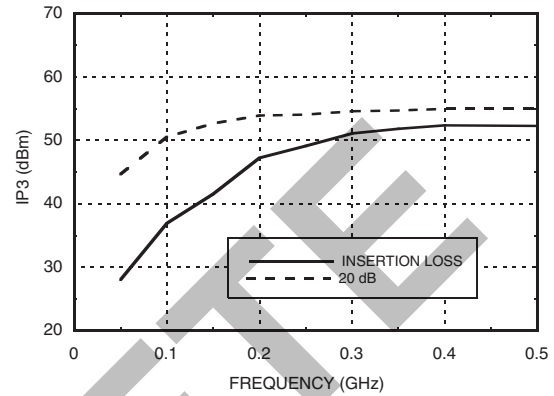

Input Power for 0.1 dB Compression* (Low Frequency Detail)

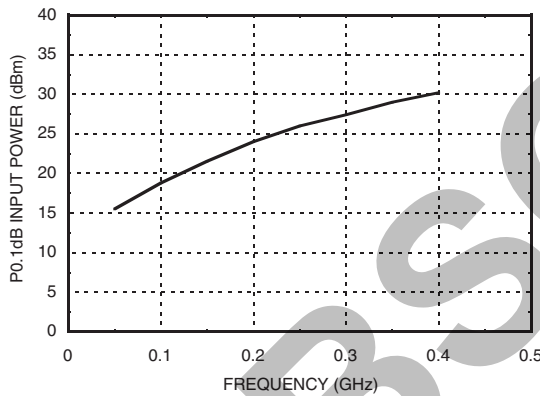

Truth Table

Control Voltage Input	Attenuation State
V1	RF1 - RF2
High	Reference Insertion Loss
Low	20 dB

Bias Voltage & Current

Vdd = +5 Vdc ± 10%	
Vdd (Vdc)	Idd (Typ.) (mA)
4.5	0.21
5.0	0.23
5.5	0.25

Control Voltage

State	Bias Condition
Low	0 to +0.8V @ -1 μA Typ.
High	+2 to +5V @ 30 μA Typ.

Note: Vdd = +5V

* For frequencies greater than 0.4 GHz, the 0.1 dB compression point is greater than the absolute maximum RF input power of 30 dBm.

20 dB GaAs MMIC 1-BIT DIGITAL POSITIVE CONTROL ATTENUATOR, DC - 10 GHz

Absolute Maximum Ratings

RF Input Power (DC - 10 GHz)	+30 dBm
Control Voltage Range (V1)	-1 to Vdd + 1V
Bias Voltage (Vdd)	+7 Vdc
Channel Temperature	150 °C
Continuous P _{diss} (T = 85 °C) (derate 12 mW/°C above 85 °C)	0.783 W
Thermal Resistance (channel to ground paddle)	83 °C/W
Storage Temperature	-65 to +150 °C
Operating Temperature	-40 to +85 °C
ESD Sensitivity (HBM)	Class 1A



ELECTROSTATIC SENSITIVE DEVICE
OBSERVE HANDLING PRECAUTIONS

Outline Drawing

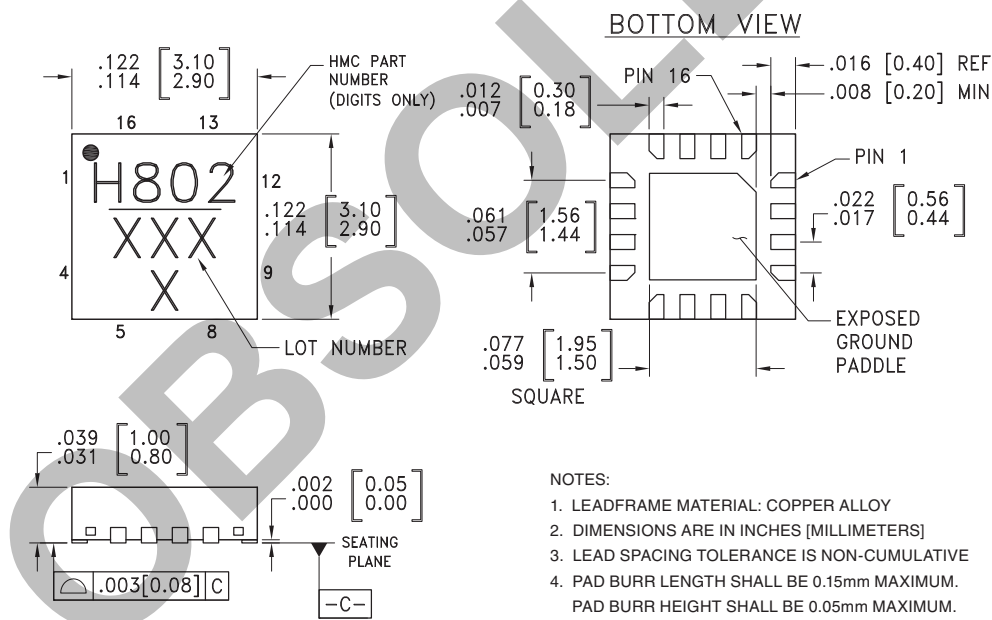

NOTES:

1. LEADFRAME MATERIAL: COPPER ALLOY
2. DIMENSIONS ARE IN INCHES [MILLIMETERS]
3. LEAD SPACING TOLERANCE IS NON-CUMULATIVE
4. PAD BURR LENGTH SHALL BE 0.15mm MAXIMUM.
PAD BURR HEIGHT SHALL BE 0.05mm MAXIMUM.
5. PACKAGE WARP SHALL NOT EXCEED 0.05mm.
6. ALL GROUND LEADS AND GROUND PADDLE MUST BE SOLDERED TO PCB RF GROUND.
7. REFER TO HITTITE APPLICATION NOTE FOR SUGGESTED LAND PATTERN.

Package Information

Part Number	Package Body Material	Lead Finish	MSL Rating	Package Marking ^[2]
HMC802LP3E	RoHS-compliant Low Stress Injection Molded Plastic	100% matte Sn	MSL1 ^[1]	H802 XXXX

[1] Max peak reflow temperature of 260 °C

[2] 4-Digit lot number XXXX



20 dB GaAs MMIC 1-BIT DIGITAL POSITIVE CONTROL ATTENUATOR, DC - 10 GHz

5

ATTENUATORS - DIGITAL - SMT

Pin Descriptions

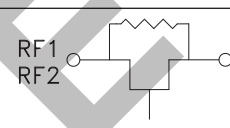
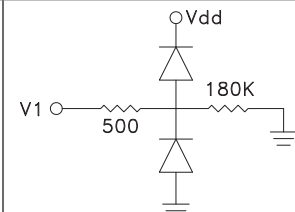
Pin Number	Function	Description	Interface Schematic
1	Vdd	Supply Voltage.	
2, 4, 9, 11	GND	These pins and the exposed ground paddle must be connected to RF/DC ground.	
3, 10	RF1, RF2	These pins are DC coupled and matched to 50 Ohms. Blocking capacitors are required. Select value based on lowest frequency of operation.	
5, 7, 8	ACG1, ACG2, ACG3	External capacitor to ground is required. Select value for lowest frequency of operation. Place capacitor as close to pins as possible.	
6, 12, 13, 15, 16	N/C	The pins are not connected internally; however, all data shown herein was measured with these pins connected to RF/DC ground externally.	
14	V1	See truth table and control voltage table.	

Application Circuit

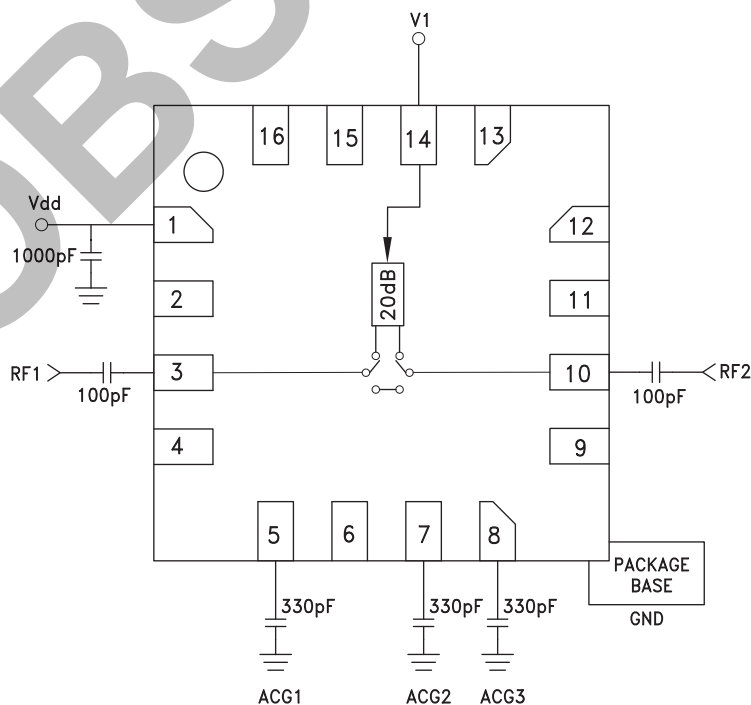

For price, delivery, and to place orders, please contact Hittite Microwave Corporation:
 20 Alpha Road, Chelmsford, MA 01824 Phone: 978-250-3343 Fax: 978-250-3373
 Order On-line at www.hittite.com

Evaluation PCB

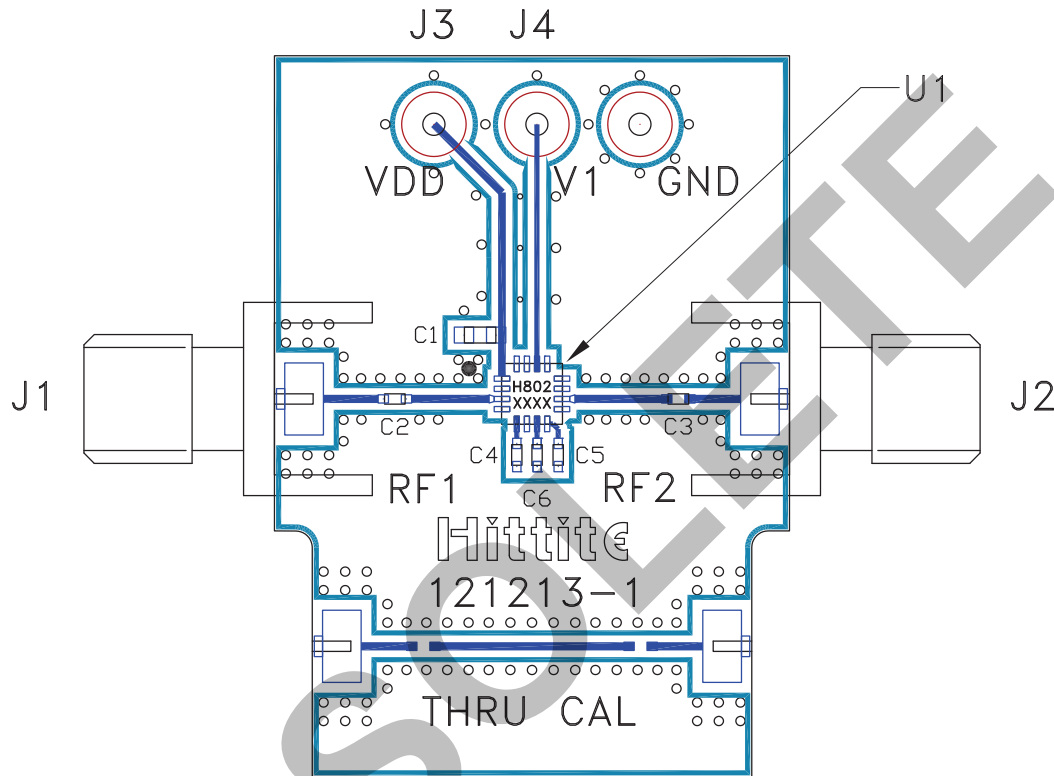

List of Materials for Evaluation PCB 127103 [1]

Item	Description
J1, J2	PCB Mount SMA Connector
J3, J4	DC Connector
C1	1000 pF Capacitor, 0603 Pkg.
C2, C3	100 pF Capacitor, 0402 Pkg.
C4 - C6	330 pF Capacitor, 0402 Pkg.
U1	HMC802LP3E Digital Attenuator
PCB [2]	121213 Evaluation PCB

[1] Reference this number when ordering complete evaluation PCB

[2] Circuit Board Material: Rogers 4350

The circuit board used in the application should use RF circuit design techniques. Signal lines should have 50 Ohm impedance while the package ground leads and exposed paddle should be connected directly to the ground plane similar to that shown. A sufficient number of via holes should be used to connect the top and bottom ground planes. The evaluation circuit board shown is available from Hittite upon request.