



pHEMT GAIN BLOCK MMIC AMPLIFIER, DC - 10 GHz

Typical Applications

The HMC788LP2E is ideal for:

- Cellular/3G & LTE/WiMAX/4G
- LO Driver Applications
- Microwave Radio
- Test & Measurement Equipment
- UWB Communications

Features

- P1dB Output Power: +20 dBm
- Output IP3: +30 dBm
- Gain: 14 dB
- 50 Ohm I/O's
- 6 Lead 2x2 mm DFN SMT Package: 4 mm²

Functional Diagram

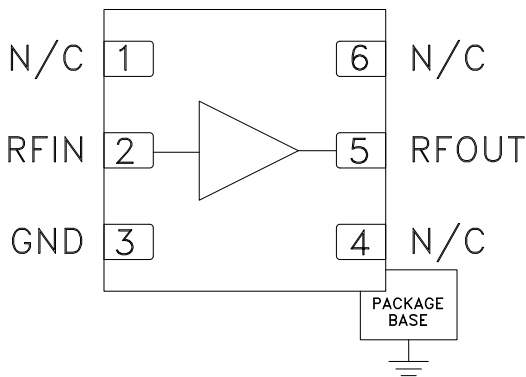

General Description

The HMC788LP2E is a GaAs pHEMT Gain Block MMIC SMT DC to 10 GHz amplifier. This 2x2 mm DFN packaged amplifier can be used as either a cascadable 50 Ohm gain stage or to drive the LO port of many of Hittite's single and double-balanced mixers with up to +20 dBm output power. The HMC788LP2E offers 14 dB of gain and an output IP3 of +30 dBm while requiring only 76 mA from a +5V supply. The Darlington feedback pair exhibits reduced sensitivity to normal process variations and yields excellent gain stability over temperature while requiring a minimal number of external bias components.

Electrical Specifications, $V_{cc} = 5V, T_A = +25^\circ C$

Parameter		Min.	Typ.	Max.	Units
Gain	DC - 6.0 GHz	12	14		dB
	6.0 - 10.0 GHz	9	12		dB
Gain Variation Over Temperature	DC - 6.0 GHz		0.012		dB/ °C
	6.0 - 10.0 GHz		0.025		dB/ °C
Return Loss Input	DC - 6.0 GHz		16		dB
	6.0 - 10.0 GHz		9		dB
Return Loss Output	DC - 6.0 GHz		9		dB
	6.0 - 10.0 GHz		15		dB
Reverse Isolation	DC - 10.0 GHz		25		dB
Output Power for 1 dB Compression (P1dB)	DC - 6.0 GHz	18	20		dBm
	6.0 - 10.0 GHz	15	18		dBm
Output Third Order Intercept (IP3)	DC - 6.0 GHz		30		dBm
	6.0 - 10.0 GHz		27		dBm
Noise Figure	DC - 6.0 GHz		7		dB
	6.0 - 10.0 GHz		9		dB
Supply Current (Icq)			76		mA

Note: Data taken with broadband bias tee on device output.



**pHEMT GAIN BLOCK
MMIC AMPLIFIER, DC - 10 GHz**

Broadband Gain & Return Loss

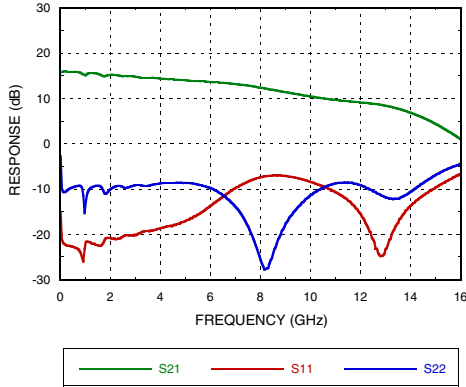

Gain vs. Temperature

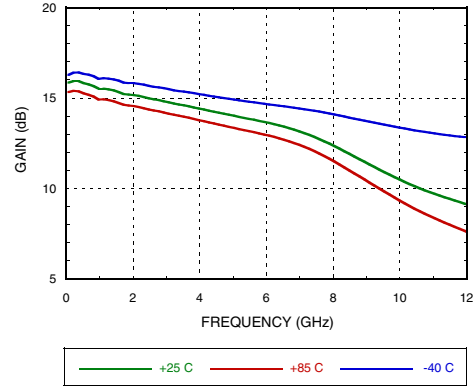

Input Return Loss vs. Temperature

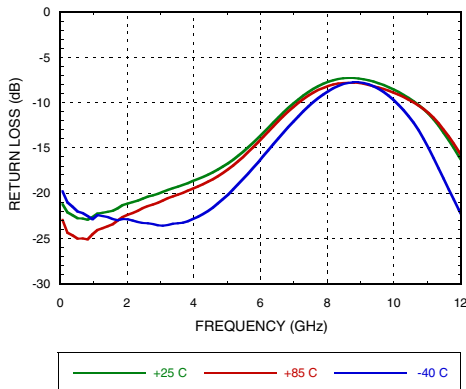

Output Return Loss vs. Temperature

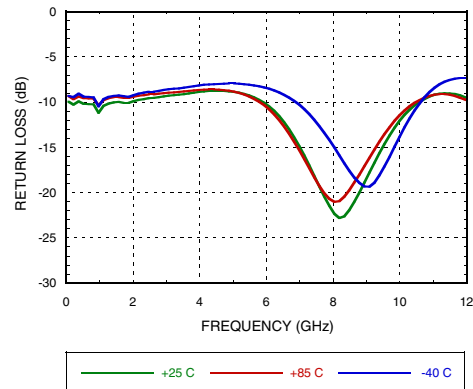

Reverse Isolation vs. Temperature

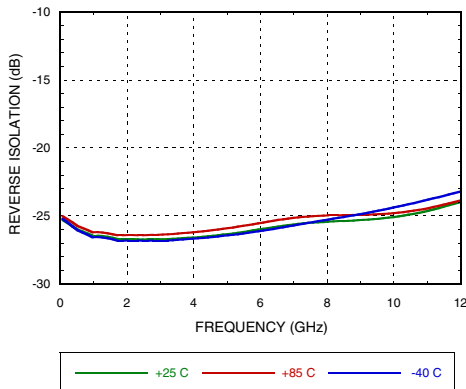

Noise Figure vs. Temperature

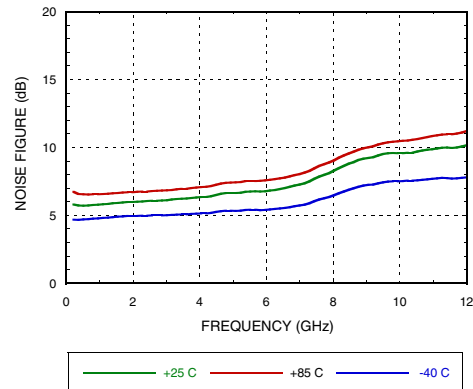

Information furnished by Analog Devices is believed to be accurate and reliable. However, no responsibility is assumed by Analog Devices for its use, nor for any infringements of patents or other rights of third parties that may result from its use. Specifications subject to change without notice. No license is granted by implication or otherwise under any patent or patent rights of Analog Devices. Trademarks and registered trademarks are the property of their respective owners.

For price, delivery, and to place orders: Analog Devices, Inc., One Technology Way, P.O. Box 9106, Norwood, MA 02062-9106 Phone: 781-329-4700 • Order online at www.analog.com Application Support: Phone: 1-800-ANALOG-D



**pHEMT GAIN BLOCK
MMIC AMPLIFIER, DC - 10 GHz**

AMPLIFIERS - DRIVER & GAIN BLOCK - SMT

P1dB vs. Temperature

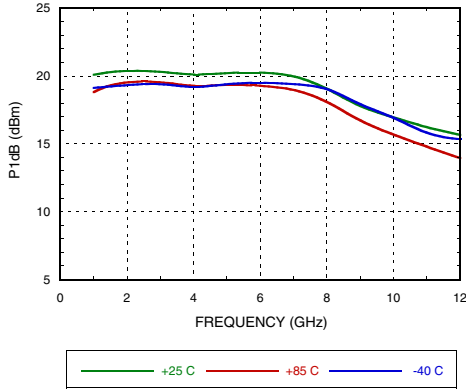

Psat vs. Temperature

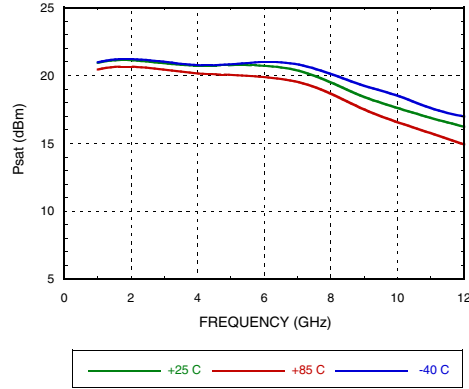

Power Compression @ 1 GHz

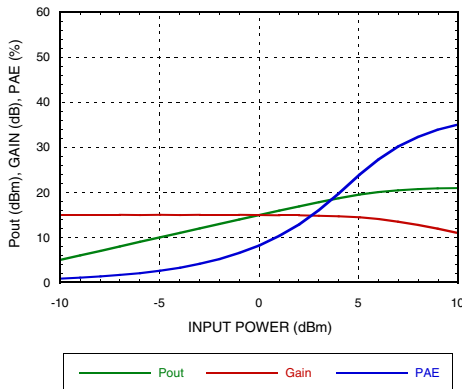

Power Compression @ 10 GHz

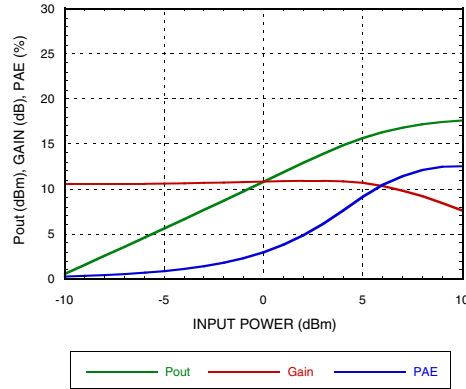

Output IP3 vs. Temperature [1]

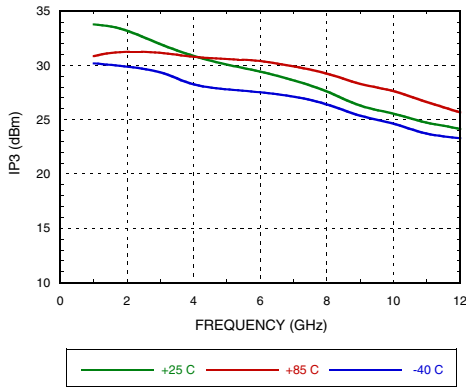

Gain & Power vs. Supply Voltage @ 1 GHz

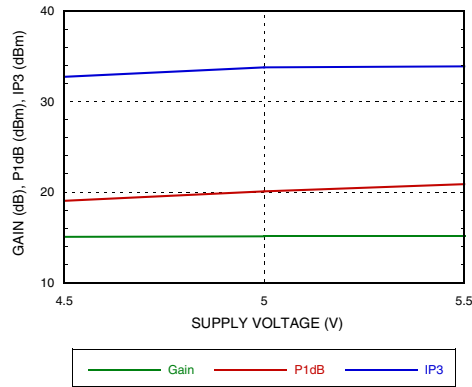

[1] +5 dBm / Tone Output Power

Information furnished by Analog Devices is believed to be accurate and reliable. However, no responsibility is assumed by Analog Devices for its use, nor for any infringements of patents or other rights of third parties that may result from its use. Specifications subject to change without notice. No license is granted by implication or otherwise under any patent or patent rights of Analog Devices. Trademarks and registered trademarks are the property of their respective owners.

For price, delivery, and to place orders: Analog Devices, Inc., One Technology Way, P.O. Box 9106, Norwood, MA 02062-9106 Phone: 781-329-4700 • Order online at www.analog.com Application Support: Phone: 1-800-ANALOG-D



pHEMT GAIN BLOCK MMIC AMPLIFIER, DC - 10 GHz

Absolute Maximum Ratings

Collector Bias Voltage (Vcc)	+7V
RF Input Power (RFIN)(Vs = +5V)	+15 dBm
Junction Temperature	150 °C
Continuous P _{diss} (T = 85 °C) (derate 10.4 mW/°C above 85 °C)	0.68 W
Thermal Resistance (junction to ground paddle)	96 °C/W
Storage Temperature	-65 to +150 °C
Operating Temperature	-40 to +85 °C
ESD Sensitivity (HBM)	Class 1A

Typical Supply Current

Vcc (V)	Ic _q (mA)
4.5	64
5.0	76
5.5	88



ELECTROSTATIC SENSITIVE DEVICE
OBSERVE HANDLING PRECAUTIONS

Outline Drawing

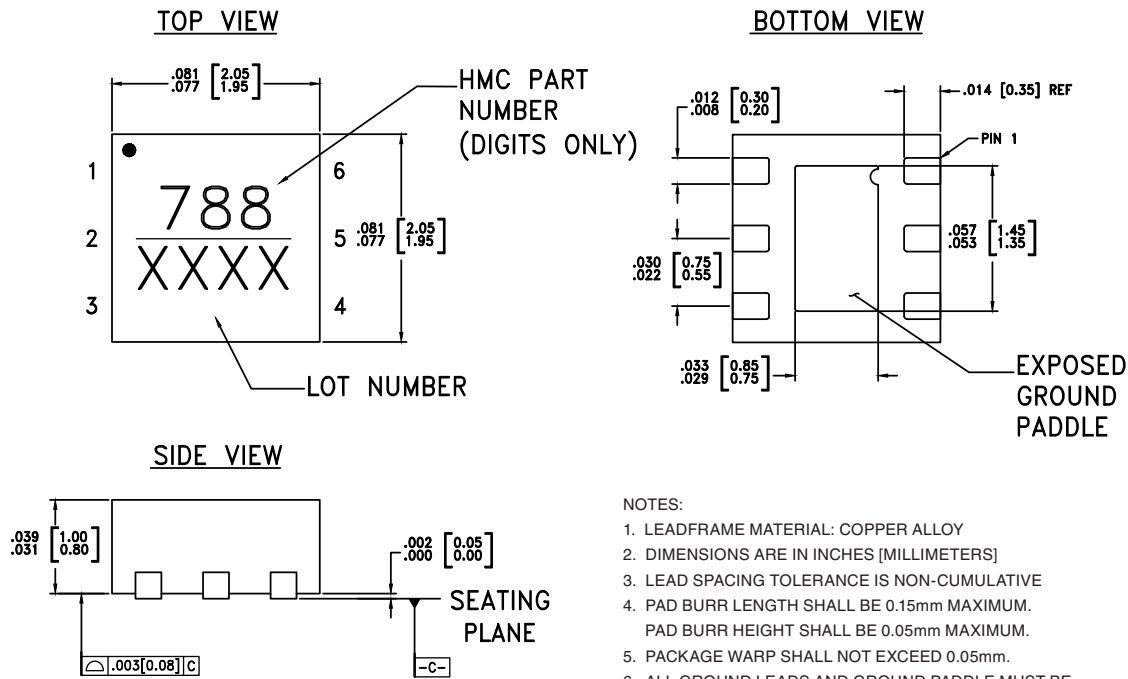

NOTES:

- LEADFRAME MATERIAL: COPPER ALLOY
- DIMENSIONS ARE IN INCHES [MILLIMETERS]
- LEAD SPACING TOLERANCE IS NON-CUMULATIVE
- PAD BURR LENGTH SHALL BE 0.15mm MAXIMUM.
PAD BURR HEIGHT SHALL BE 0.05mm MAXIMUM.
- PACKAGE WARP SHALL NOT EXCEED 0.05mm.
- ALL GROUND LEADS AND GROUND PADDLE MUST BE SOLDERED TO PCB RF GROUND.
- REFER TO HITTITE APPLICATION NOTE FOR SUGGESTED LAND PATTERN.

Package Information

Part Number	Package Body Material	Lead Finish	MSL Rating	Package Marking ^[1]
HMC788LP2E	RoHS-compliant Low Stress Injection Molded Plastic	100% matte Sn	MSL1 ^[2]	788 XXXX

[1] 4-Digit lot number XXXX

[2] Max peak reflow temperature of 260 °C



**pHEMT GAIN BLOCK
MMIC AMPLIFIER, DC - 10 GHz**

Pin Descriptions

Pin Number	Function	Description	Interface Schematic
1, 4, 6	N/C	The pins are not connected internally; however, all data shown herein was measured with these pins connected to RF/DC ground externally.	
2	RFIN	This pin is DC coupled. An off chip DC blocking capacitor is required.	
5	RFOUT	RF output and DC Bias for the output stage.	
3	GND	This pin and exposed ground paddle must be connected to RF/DC ground.	

Application Circuit

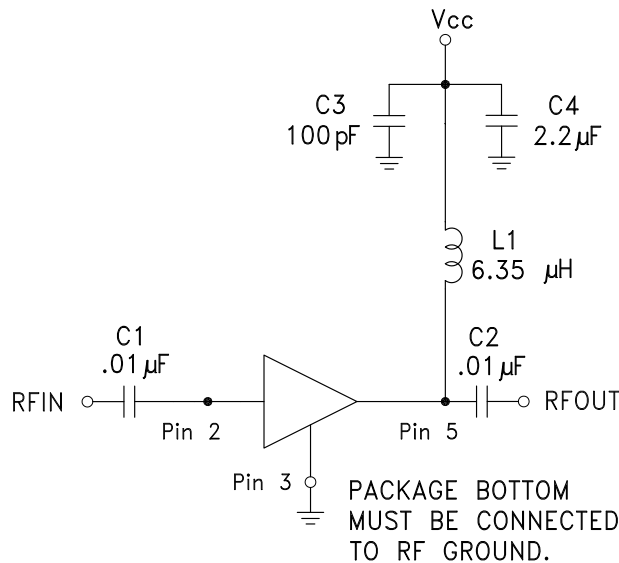

Information furnished by Analog Devices is believed to be accurate and reliable. However, no responsibility is assumed by Analog Devices for its use, nor for any infringements of patents or other rights of third parties that may result from its use. Specifications subject to change without notice. No license is granted by implication or otherwise under any patent or patent rights of Analog Devices. Trademarks and registered trademarks are the property of their respective owners.

For price, delivery, and to place orders: Analog Devices, Inc., One Technology Way, P.O. Box 9106, Norwood, MA 02062-9106 Phone: 781-329-4700 • Order online at www.analog.com Application Support: Phone: 1-800-ANALOG-D



pHEMT GAIN BLOCK MMIC AMPLIFIER, DC - 10 GHz

Evaluation PCB

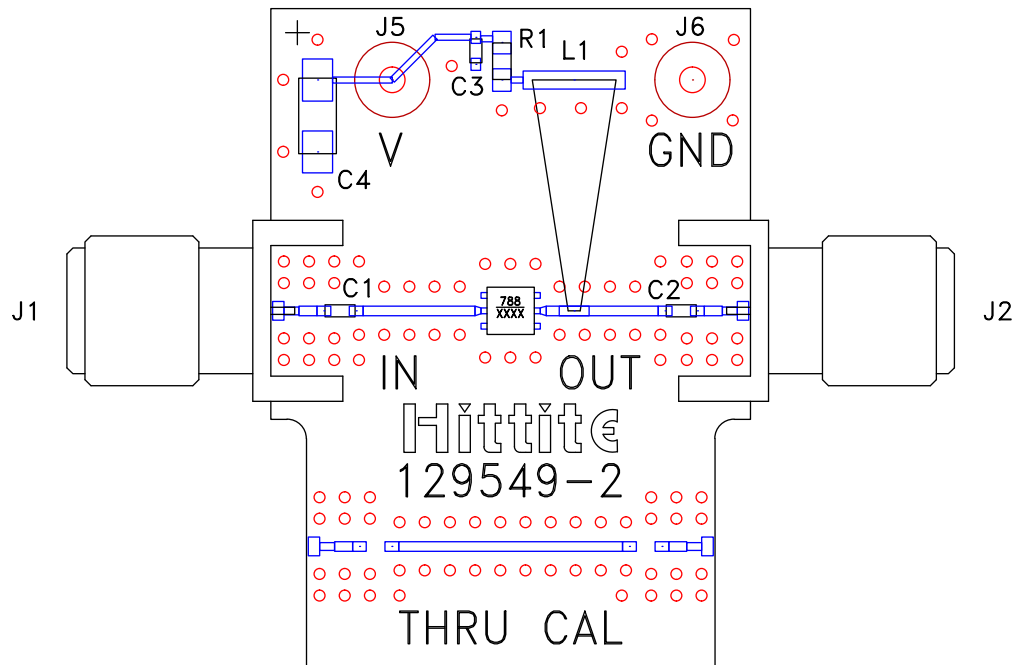

List of Materials for Evaluation PCB 129550 [1]

Item	Description
J1 - J2	PC Mount SMA Connector
J5, J6	DC Pin
C1, C2	0.01 μ F Capacitor, 0502 Pkg.
C3	100 pF Capacitor, 0402 Pkg.
C4	2.2 μ F Case A Pkg.
R1	0 Ohm Resistor, 0402 Pkg.
L1	Inductor, Conical 6.35 μ H
U1	HMC788LP2E
PCB [2]	129549 Evaluation PCB

[1] Reference this number when ordering complete evaluation PCB

[2] Circuit Board Material: Rogers 4350

The circuit board used in the application should use RF circuit design techniques. Signal lines should have 50 Ohm impedance while the package ground leads and exposed paddle should be connected directly to the ground plane similar to that shown. A sufficient number of via holes should be used to connect the top and bottom ground planes. The evaluation board should be mounted to an appropriate heat sink. The evaluation circuit board shown is available from Hittite upon request.