



GaAs MMIC VOLTAGE-VARIABLE ATTENUATOR, 5 - 26.5 GHz

Typical Applications

The HMC712LP3CE is ideal for:

- Point-to-Point Radio
- VSAT Radio
- Test Instrumentation
- Microwave Sensors
- Military, ECM & Radar

Features

- Wide Bandwidth: 5 - 26.5 GHz
- Excellent Linearity: +28 dBm Input P1dB
- Wide Attenuation Range: 28 dB
- Absorptive Topology
- Singe or Dual Control Operation
- 16 Lead 3x3mm SMT Package: 9mm²

Functional Diagram

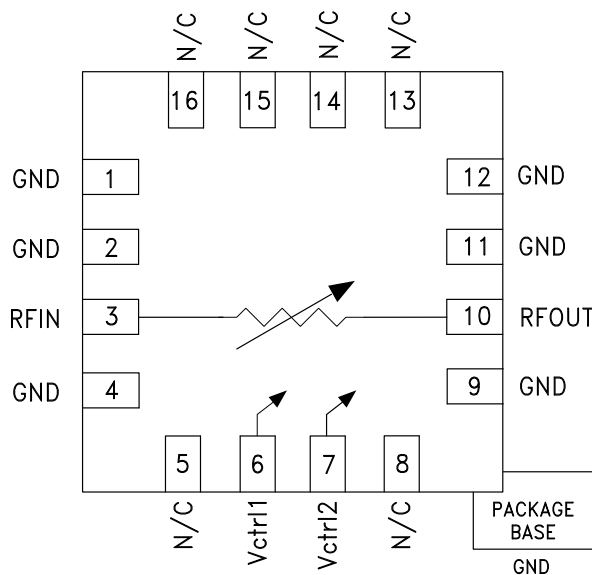

General Description

The HMC712LP3CE is an absorptive Voltage Variable Attenuator (VVA) which operates from 5 - 26.5 GHz and is ideal in designs where an analog DC control signal must be used to control RF signal levels over a 28 dB amplitude range. It features two shunt-type attenuators which are controlled by two analog voltages, Vctrl1 and Vctrl2. Optimum linearity performance of the attenuator is achieved by first varying Vctrl1 of the 1st attenuation stage from -3V to 0V with Vctrl2 fixed at -3V. The control voltage of the 2nd attenuation stage, Vctrl2, should then be varied from -3V to 0V, with Vctrl1 fixed at 0V. The HMC712LP3CE is housed in a RoHS compliant 3x3 mm QFN leadless package

However, if the Vctrl1 and Vctrl2 pins are connected together it is possible to achieve the full analog attenuation range with only a small degradation in input IP3 performance. Applications include AGC circuits and temperature compensation of multiple gain stages in microwave point-to-point and VSAT radios.

Electrical Specifications, $T_A = +25^\circ C$, 50 Ohm system

| Parameter | Min. | Typ. | Max. | Units |
|--------------------------------------------------------------------------|-------------|------|------|-------|
| Insertion Loss | | 3.5 | | dB |
| | 5 - 16 GHz | | 4.5 | dB |
| | 16 - 24 GHz | | 5.5 | dB |
| 24 - 26.5 GHz | | | | dB |
| Attenuation Range | | 28 | | dB |
| Input Return Loss | | 12 | | dB |
| Output Return Loss | | 10 | | dB |
| Input Power for 1 dB Compression (any attenuation) | | 28 | | dBm |
| Input Third Order Intercept (Two-tone Input Power = 10 dBm Each Tone) | | 32 | | dBm |

Information furnished by Analog Devices is believed to be accurate and reliable. However, no responsibility is assumed by Analog Devices for its use, nor for any infringements of patents or other rights of third parties that may result from its use. Specifications subject to change without notice. No license is granted by implication or otherwise under any patent or patent rights of Analog Devices. Trademarks and registered trademarks are the property of their respective owners.

For price, delivery, and to place orders: Analog Devices, Inc., One Technology Way, P.O. Box 9106, Norwood, MA 02062-9106 Phone: 781-329-4700 • Order online at www.analog.com Application Support: Phone: 1-800-ANALOG-D



GaAs MMIC VOLTAGE-VARIABLE ATTENUATOR, 5 - 26.5 GHz

Attenuation vs. Frequency over Vctrl
Vctrl1 = Variable, Vctrl2 = -3V

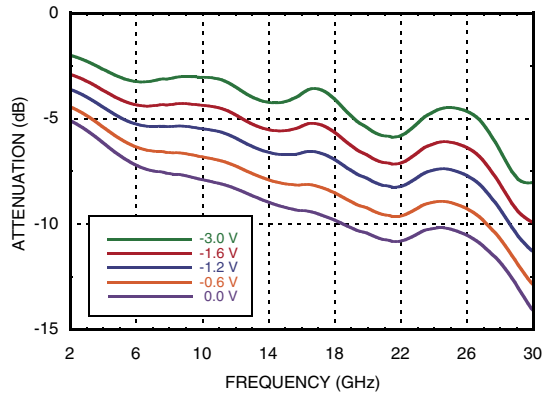

Attenuation vs. Frequency over Vctrl
Vctrl1 = 0V, Vctrl2 = Variable

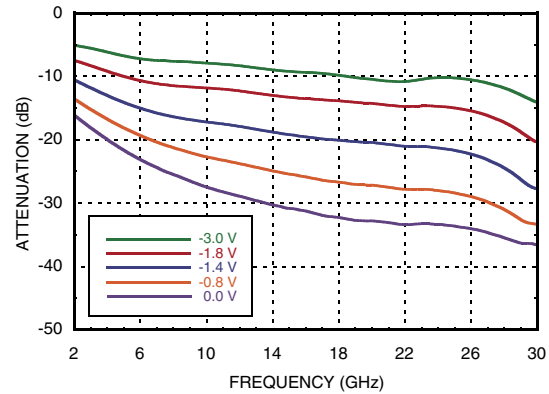

Attenuation vs. Vctrl1
Over Temperature @ 10 GHz, Vctrl2 = -3V

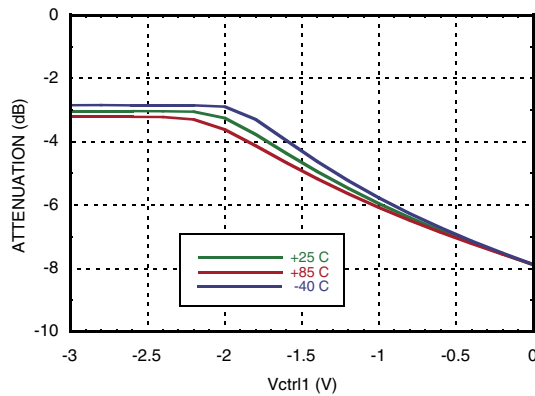

Attenuation vs. Vctrl2
Over Temperature @ 10 GHz, Vctrl1 = 0V

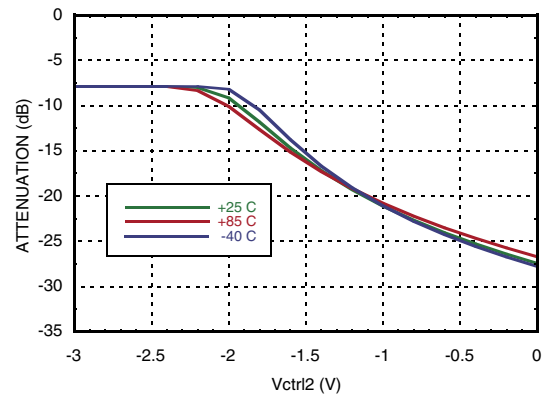

Attenuation vs. Pin @ 10 GHz
Vctrl1 = Variable, Vctrl2 = -3V

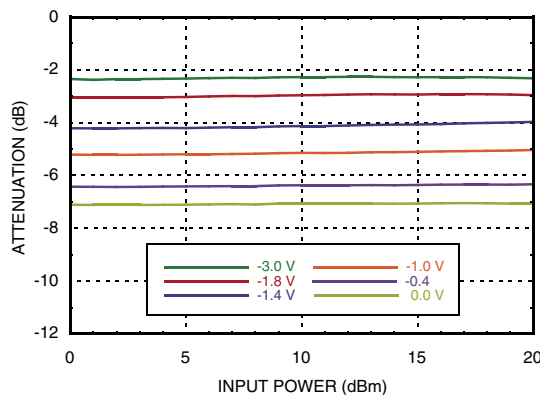

Information furnished by Analog Devices is believed to be accurate and reliable. However, no responsibility is assumed by Analog Devices for its use, nor for any infringements of patents or other rights of third parties that may result from its use. Specifications subject to change without notice. No license is granted by implication or otherwise under any patent or patent rights of Analog Devices. Trademarks and registered trademarks are the property of their respective owners.

For price, delivery, and to place orders: Analog Devices, Inc., One Technology Way, P.O. Box 9106, Norwood, MA 02062-9106 Phone: 781-329-4700 • Order online at www.analog.com Application Support: Phone: 1-800-ANALOG-D



GaAs MMIC VOLTAGE-VARIABLE ATTENUATOR, 5 - 26.5 GHz

ATTENUATOR - ANALOG - SMT

Insertion Phase vs. V_{ctrl1} , $V_{ctrl2} = -3V$

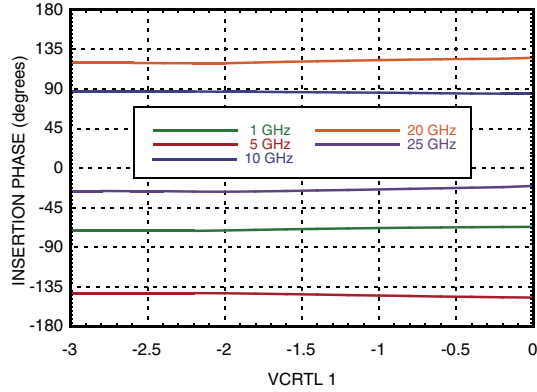

Insertion Phase vs. V_{ctrl2} , $V_{ctrl1} = 0V$

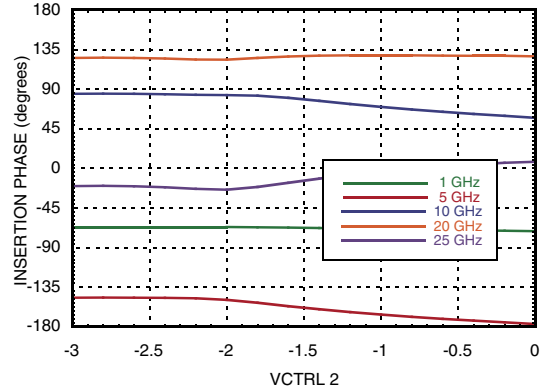

**Input Return Loss
 $V_{ctrl1} = \text{Variable}$, $V_{ctrl2} = -3V$**

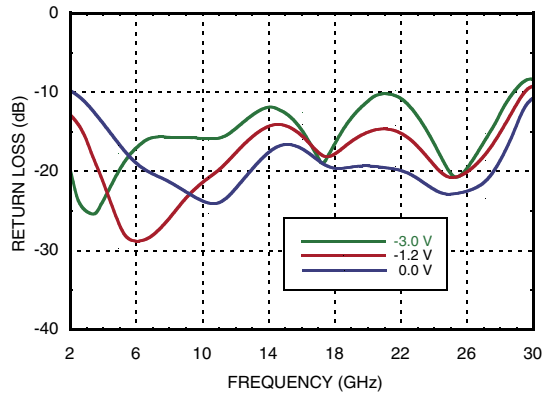

**Input Return Loss
 $V_{ctrl1} = 0V$, $V_{ctrl2} = \text{Variable}$**

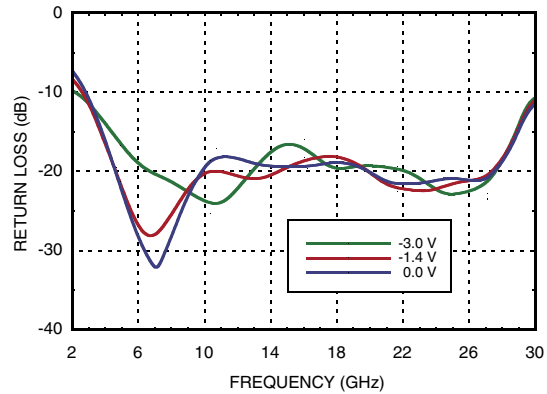

**Output Return Loss
 $V_{ctrl1} = \text{Variable}$, $V_{ctrl2} = -3V$**

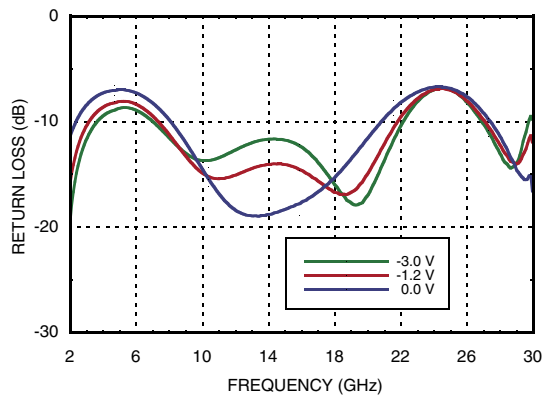

**Output Return Loss
 $V_{ctrl1} = 0V$, $V_{ctrl2} = \text{Variable}$**

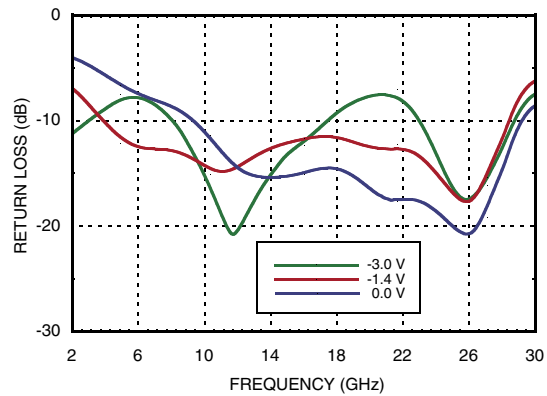

Information furnished by Analog Devices is believed to be accurate and reliable. However, no responsibility is assumed by Analog Devices for its use, nor for any infringements of patents or other rights of third parties that may result from its use. Specifications subject to change without notice. No license is granted by implication or otherwise under any patent or patent rights of Analog Devices. Trademarks and registered trademarks are the property of their respective owners.

For price, delivery, and to place orders: Analog Devices, Inc., One Technology Way, P.O. Box 9106, Norwood, MA 02062-9106 Phone: 781-329-4700 • Order online at www.analog.com Application Support: Phone: 1-800-ANALOG-D



GaAs MMIC VOLTAGE-VARIABLE ATTENUATOR, 5 - 26.5 GHz

Input IP3 vs Input Power @ 10 GHz
Vctrl1 = Variable, Vctrl2 = -3V

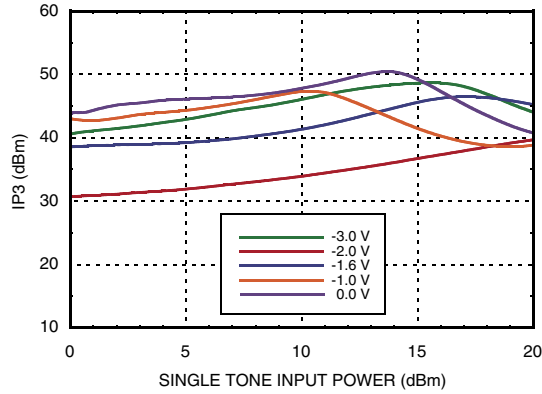

Input IP3 vs. Input Power Over Frequency
Vctrl1 = -2.0V, Vctrl2 = -3V (Worst Case IP3)

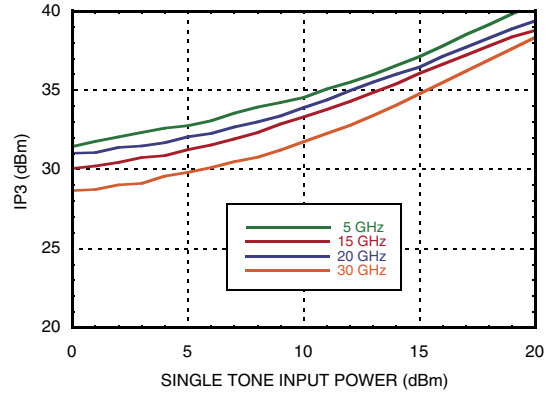

Input IP3 vs. Input Power Over Temperature
 @ 10 GHz, *Vctrl1 = -2.0V, Vctrl2 = -3V*

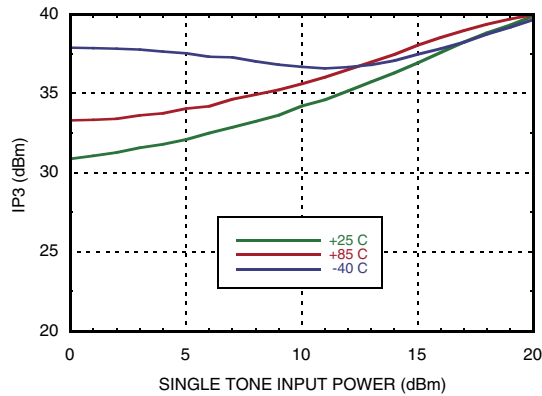

Attenuation vs. Frequency over Vctrl
Vctrl1 = Vctrl2

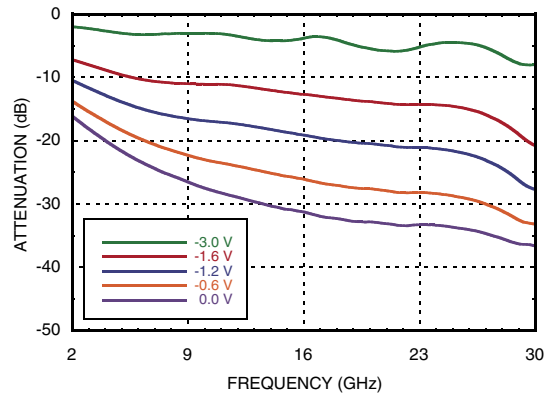

Attenuation vs. Vctrl over Temperature
 @ 10 GHz, *Vctrl1 = Vctrl2*

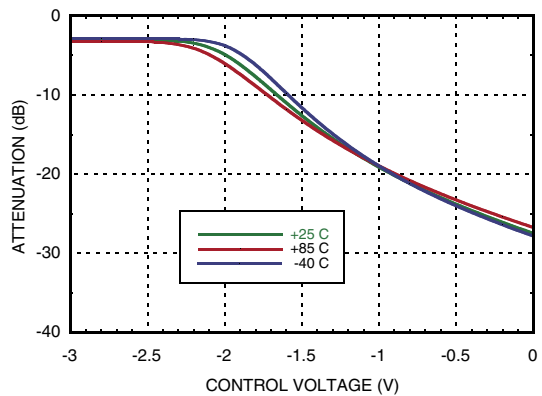

Attenuation vs. Input Power over Vctrl
Vctrl1 = Vctrl2

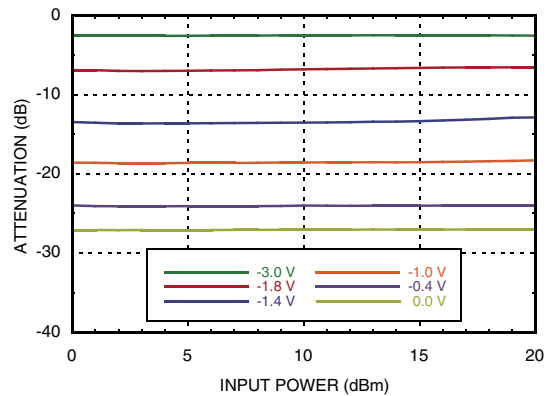

Information furnished by Analog Devices is believed to be accurate and reliable. However, no responsibility is assumed by Analog Devices for its use, nor for any infringements of patents or other rights of third parties that may result from its use. Specifications subject to change without notice. No license is granted by implication or otherwise under any patent or patent rights of Analog Devices. Trademarks and registered trademarks are the property of their respective owners.

For price, delivery, and to place orders: Analog Devices, Inc., One Technology Way, P.O. Box 9106, Norwood, MA 02062-9106 Phone: 781-329-4700 • Order online at www.analog.com Application Support: Phone: 1-800-ANALOG-D



GaAs MMIC VOLTAGE-VARIABLE ATTENUATOR, 5 - 26.5 GHz

Input Return Loss, Vctrl1 = Vctrl2

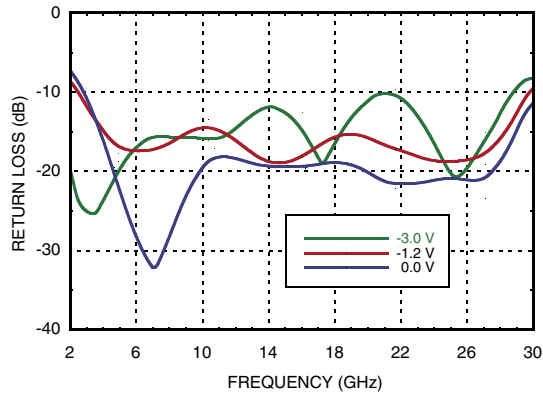

Output Return Loss, Vctrl1 = Vctrl2

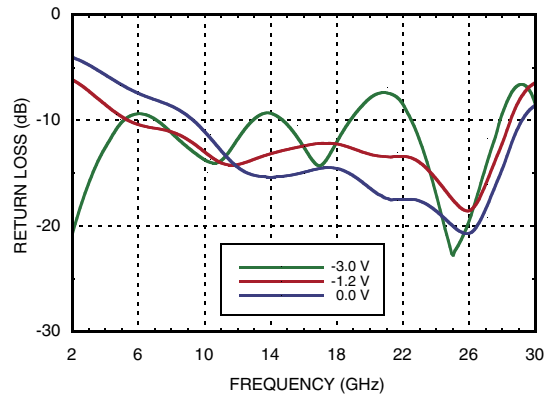

Input IP3 vs. Input Power Over Vctrl @ 10 GHz, Vctrl1 = Vctrl2

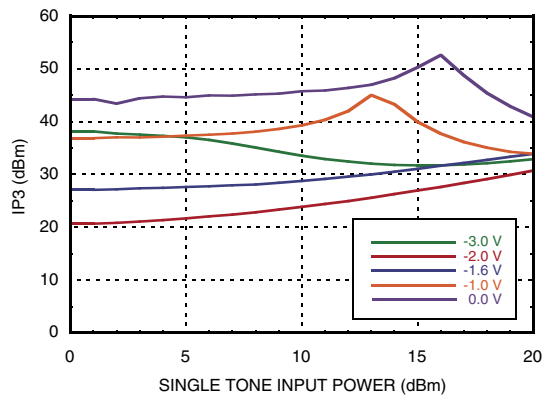

Absolute Maximum Ratings

| | |
|-----------------------------------------------|----------------|
| RF Input Power | +30 dBm |
| Control Voltage Range | +1 to -5V |
| Channel Temperature | 150 °C |
| Continuous Pdiss (T = 85 °C) | 1W |
| Thermal Resistance (Channel to ground paddle) | 66 °C/W |
| Storage Temperature | -65 to +150 °C |
| Operating Temperature | -40 to +85 °C |
| ESD Sensitivity (HBM) | Class 1A |

Control Voltages

| | |
|--------|------------------|
| Vctrl1 | -3 to 0V @ 10 μA |
| Vctrl2 | -3 to 0V @ 10 μA |



**ELECTROSTATIC SENSITIVE DEVICE
OBSERVE HANDLING PRECAUTIONS**

Information furnished by Analog Devices is believed to be accurate and reliable. However, no responsibility is assumed by Analog Devices for its use, nor for any infringements of patents or other rights of third parties that may result from its use. Specifications subject to change without notice. No license is granted by implication or otherwise under any patent or patent rights of Analog Devices. Trademarks and registered trademarks are the property of their respective owners.

For price, delivery, and to place orders: Analog Devices, Inc., One Technology Way, P.O. Box 9106, Norwood, MA 02062-9106 Phone: 781-329-4700 • Order online at www.analog.com Application Support: Phone: 1-800-ANALOG-D



GaAs MMIC VOLTAGE-VARIABLE ATTENUATOR, 5 - 26.5 GHz

Outline Drawing

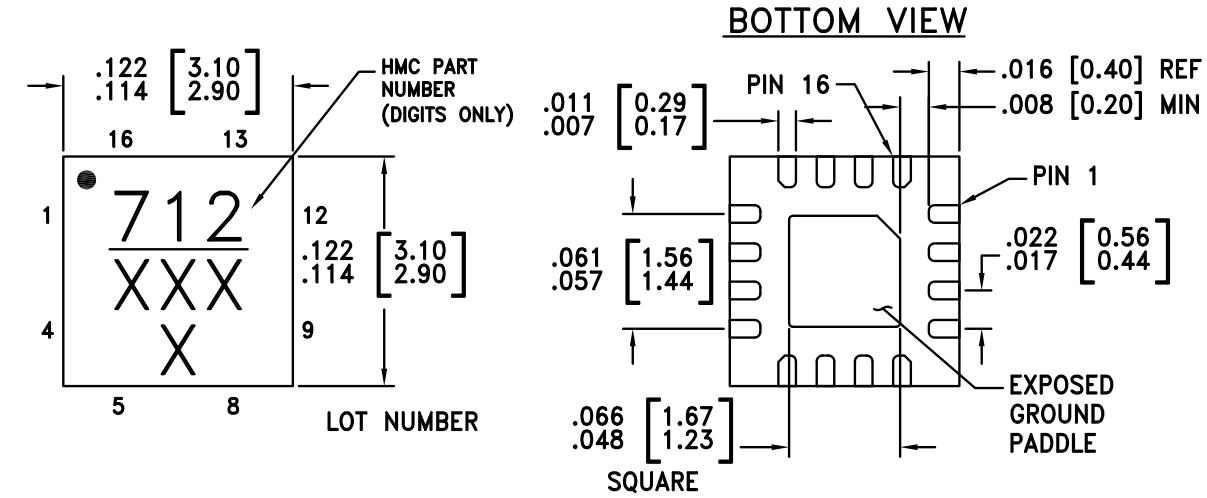

- NOTES:
1. PACKAGE BODY MATERIAL: LOW STRESS INJECTION MOLDED PLASTIC SILICA AND SILICON IMPREGNATED.
 2. LEAD AND GROUND PADDLE MATERIAL: COPPER ALLOY.
 3. LEAD AND GROUND PADDLE PLATING: 100% MATTE TIN.
 4. DIMENSIONS ARE IN INCHES [MILLIMETERS].
 5. LEAD SPACING TOLERANCE IS NON-CUMULATIVE.
 6. PAD BURR LENGTH SHALL BE 0.15mm MAX. PAD BURR HEIGHT SHALL BE 0.05mm MAX.
 7. PACKAGE WARP SHALL NOT EXCEED 0.05mm
 8. ALL GROUND LEADS AND GROUND PADDLE MUST BE SOLDERED TO PCB RF GROUND.
 9. REFER TO HITTITE APPLICATION NOTE FOR SUGGESTED PCB LAND PATTERN.

Package Information

| Part Number | Package Body Material | Lead Finish | MSL Rating | Package Marking ^[1] |
|-------------|----------------------------------------------------|---------------|---------------------|--------------------------------|
| HMC712LP3CE | RoHS-compliant Low Stress Injection Molded Plastic | 100% matte Sn | MSL1 ^[2] | H712 XXXX |

[1] 4-Digit lot number XXXX
 [2] Max peak reflow temperature of 260 °C



GaAs MMIC VOLTAGE-VARIABLE ATTENUATOR, 5 - 26.5 GHz

Pin Descriptions

| Pin Number | Function | Description | Interface Schematic |
|-------------------------------------|----------|--------------------------------------------------------------------------------------------------------------------------|---------------------|
| 1, 2, 4, 9, 11, 12 Ground Paddle | GND | Ground paddle must be connected to RF/DC ground. | |
| 3 | RFIN | This pin is DC coupled and matched to 50 Ohms. A blocking capacitor is required if RF line potential is not equal to 0V. | |
| 5, 8, 13 - 16 | N/C | These pins should be connected to PCB RF ground to maximize performance. | |
| 6 | Vctrl1 | Control Voltage 1 | |
| 7 | Vctrl2 | Control Voltage 2 | |
| 10 | RFOUT | This pin is DC coupled and matched to 50 Ohms. A blocking capacitor is required if RF line potential is not equal to 0V. | |

Application Circuit

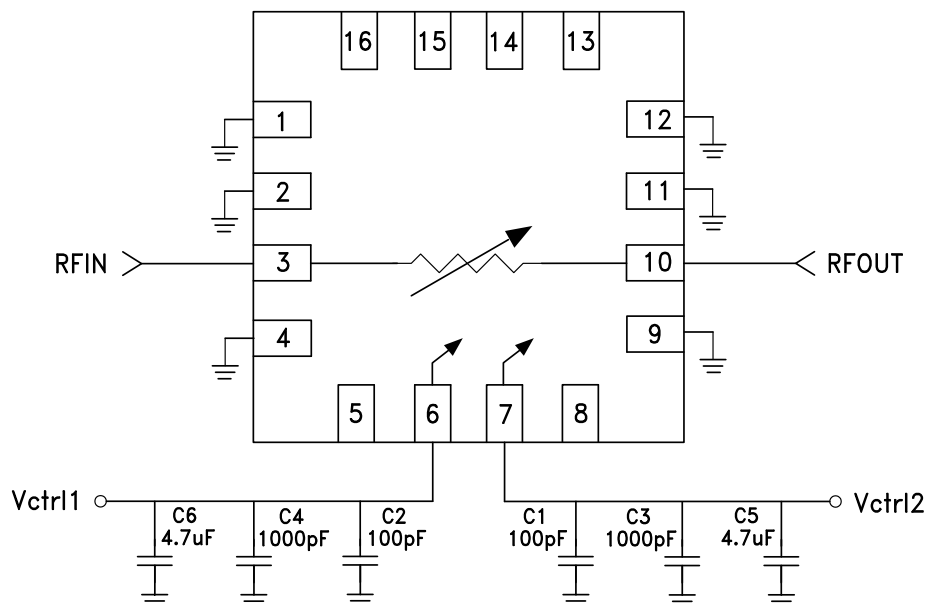

Information furnished by Analog Devices is believed to be accurate and reliable. However, no responsibility is assumed by Analog Devices for its use, nor for any infringements of patents or other rights of third parties that may result from its use. Specifications subject to change without notice. No license is granted by implication or otherwise under any patent or patent rights of Analog Devices. Trademarks and registered trademarks are the property of their respective owners.

For price, delivery, and to place orders: Analog Devices, Inc., One Technology Way, P.O. Box 9106, Norwood, MA 02062-9106 Phone: 781-329-4700 • Order online at www.analog.com Application Support: Phone: 1-800-ANALOG-D

**GaAs MMIC VOLTAGE-VARIABLE
ATTENUATOR, 5 - 26.5 GHz**



Evaluation PCB

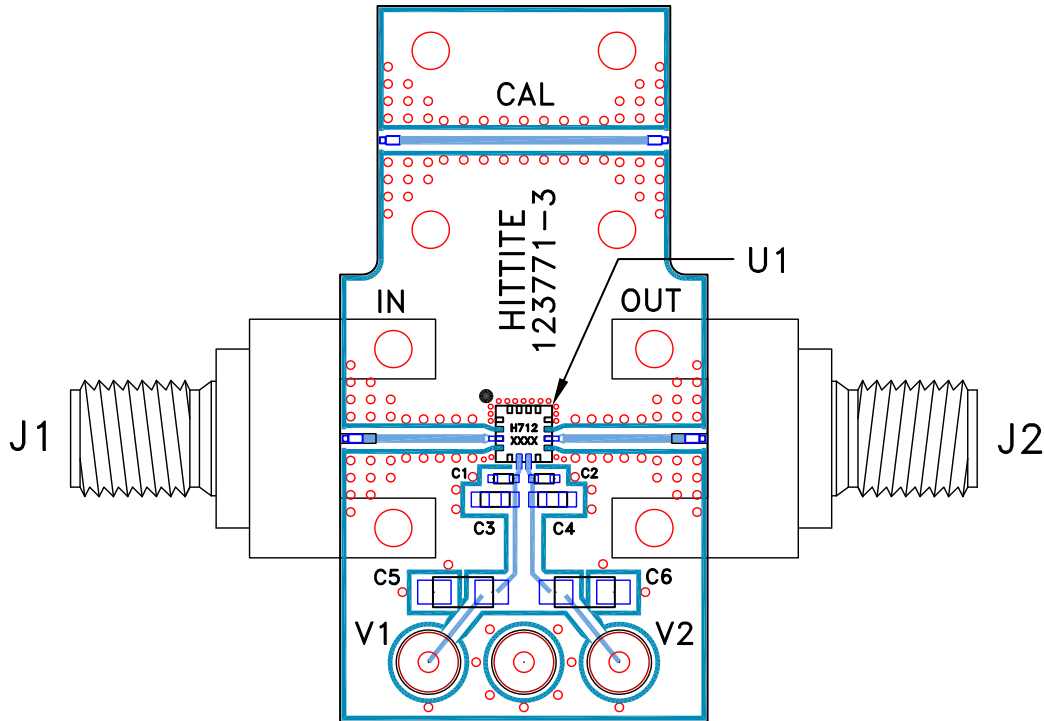

List of Materials for Evaluation PCB 123773 [1]

| Item | Description |
|---------|-----------------------------------------|
| J1, J2 | PCB Mount SMA RF Connector |
| C1, C2 | 100 pF Capacitor, 0402 Pkg. |
| C3, C4 | 1000 pF Capacitor, 0603 Pkg. |
| C5, C6 | 4.7 μF Capacitor, Tantalum |
| V1, V2 | DC Pin |
| U1 | HMC712LP3CE Voltage Variable Attenuator |
| PCB [2] | 123771 Evaluation PCB |

[1] Reference this number when ordering complete evaluation PCB

[2] Circuit Board Material: Arlon 25FR or Rogers 4350

The circuit board used in the final application should use RF circuit design techniques. Signal lines should have 50 Ohm impedance while the package ground leads and exposed paddle should be connected directly to the ground plane similar to that shown. A sufficient number of via holes should be used to connect the top and bottom ground planes. The evaluation circuit board shown is available from Hittite upon request.