

Analog Devices Welcomes Hittite Microwave Corporation

NO CONTENT ON THE ATTACHED DOCUMENT HAS CHANGED



THIS PAGE INTENTIONALLY LEFT BLANK



GaAs MMIC ANALOG VARIABLE GAIN AMPLIFIER, 0.4 - 3.0 GHz

Typical Applications

The HMC640LP5(E) is ideal for:

- Cellular/3G Infrastructure
- WiBro / WiMAX / 4G
- Microwave Radio & VSAT
- Test Equipment and Sensors
- IF & RF Applications

Functional Diagram

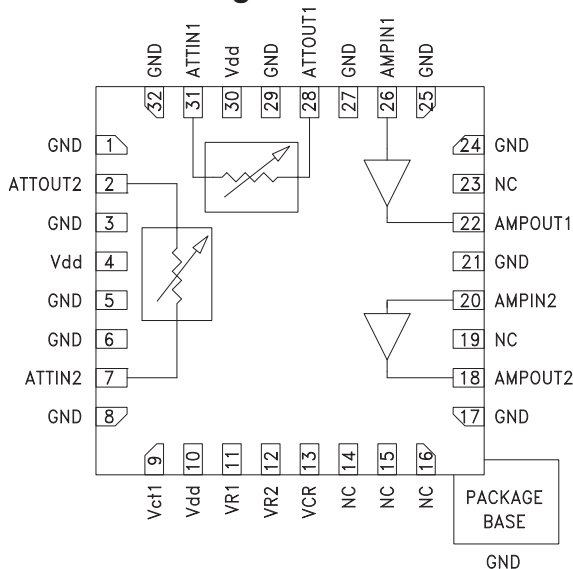

Features

- Wide Gain Control Range: up to 40 dB
- High Output IP3: +40 dBm
- Can be configured with 1 or 2 attenuator sections
- 32 Lead 5x5mm SMT Package: 25mm²

General Description

The HMC640LP5(E) is an analog controlled variable gain amplifier which operates from 0.4 to 3 GHz, and can be controlled to provide anywhere from 20 dB attenuation, to 25 dB of gain. The HMC640LP5(E) delivers noise figure of 5 dB in its maximum gain state, with output IP3 of up to +40 dBm in any state. The HMC640LP5(E) Can be configured with one attenuator for 20 dB of range, or with two attenuators for 40 dB of range. The HMC640LP5(E) is housed in a RoHS compliant 5x5 mm QFN leadless package, and requires no external matching components.

Electrical Specifications, $T_A = +25^\circ\text{C}$, 50 Ohm System, $V_{dd} = +5V$

Parameter	Frequency	Min.	Typ.	Max.	Units
Gain ($V_{ct1} = 0V$)	1 Attenuator Operation	0.4 - 2.0 GHz	17	22	dB
		2.0 - 3.0 GHz	10	17	dB
	2 Attenuator Operation	0.4 - 2.0 GHz	12	20	dB
		2.0 - 3.0 GHz	5	12	dB
Gain Control Range	1 Attenuator Operation	0.4 - 2.0 GHz		20	dB
		2.0 - 3.0 GHz		20	dB
	2 Attenuator Operation	0.4 - 2.0 GHz		40	dB
		2.0 - 3.0 GHz		35	dB
Input Return Loss	0.4 - 3.0 GHz		15		dB
Output Return Loss	0.4 - 3.0 GHz		10		dB
Output Power for 1dB Compression @ 900 MHz Min. Attenuation	0.4 - 3.0 GHz		23		dBm
Output Third Order Intercept Point (Two-Tone Output Power= 0 dBm Each Tone)	0.4 - 3.0 GHz		40		dBm
Noise Figure	0.4 - 1.0 GHz		5		dB
	1.0 - 2.0 GHz		6		dB
	2.0 - 3.0 GHz		8		dB
Group Delay	0.4 - 3.0 GHz		500		ps
Attenuation Switching Speed ^[1]	0.4 - 3.0 GHz		200		ns
Supply Current (I_{dd})	0.4 - 3.0 GHz		265	325	mA

[1] The switching speed is measured for a 15 dB change in the attenuation, and for the 90% to 10% change in the control signal.

For price, delivery, and to place orders, please contact Hittite Microwave Corporation:
20 Alpha Road, Chelmsford, MA 01824 Phone: 978-250-3343 Fax: 978-250-3373
Order On-line at www.hittite.com



GaAs MMIC ANALOG VARIABLE GAIN AMPLIFIER, 0.4 - 3.0 GHz

Gain vs. Control @ 900 MHz, 1 Attenuator

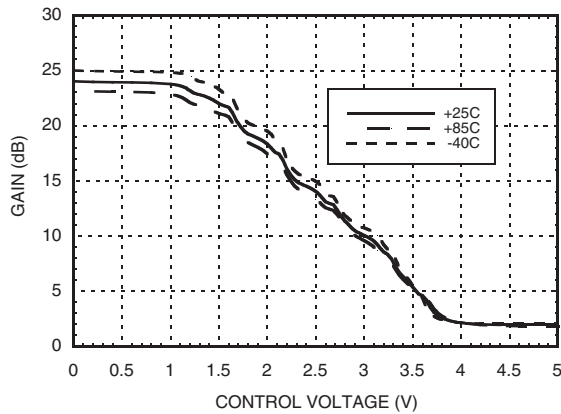

Gain vs. Control @ 900 MHz, 2 Attenuators

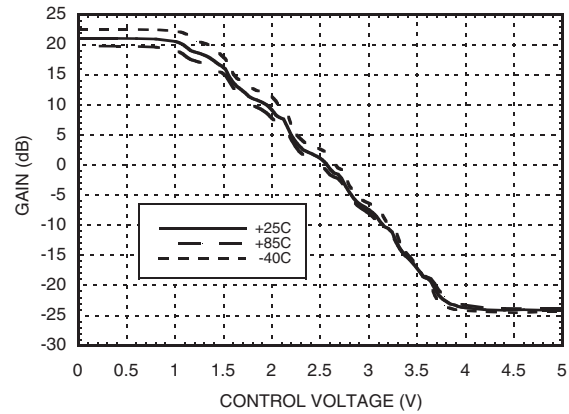

Gain vs. Control @ 1900 MHz, 1 Attenuator

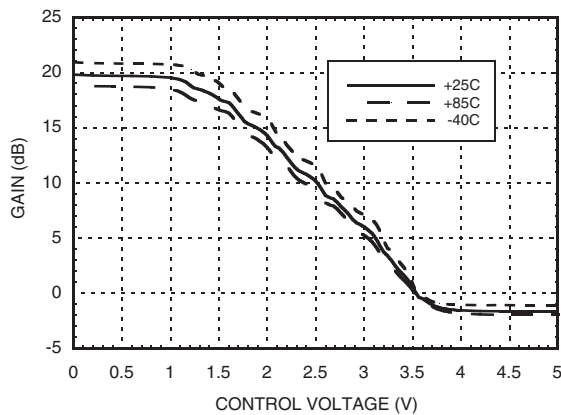

Gain vs. Control @ 1900 MHz, 2 Attenuators

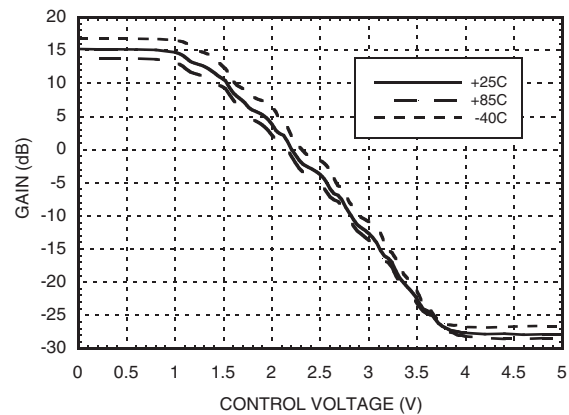

Gain vs. Control @ 2400 MHz, 1 Attenuator

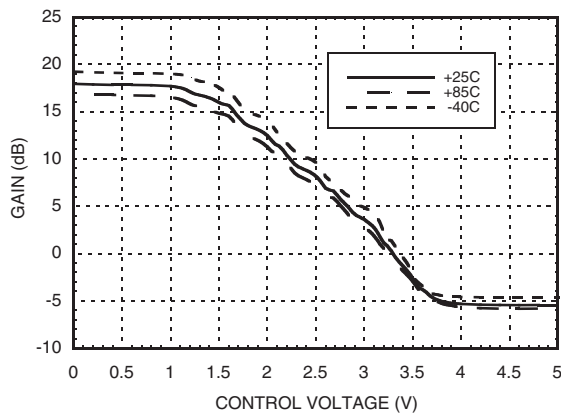

Gain vs. Control @ 2400 MHz, 2 Attenuators

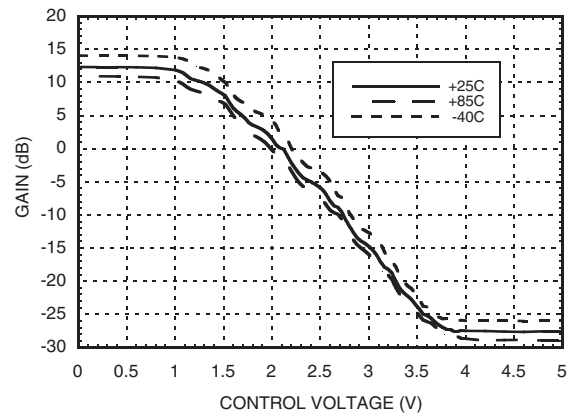

For price, delivery, and to place orders, please contact Hittite Microwave Corporation:
20 Alpha Road, Chelmsford, MA 01824 Phone: 978-250-3343 Fax: 978-250-3373
Order On-line at www.hittite.com



GaAs MMIC ANALOG VARIABLE GAIN AMPLIFIER, 0.4 - 3.0 GHz

Gain vs. Control vs. Frequency, 1 Attenuator

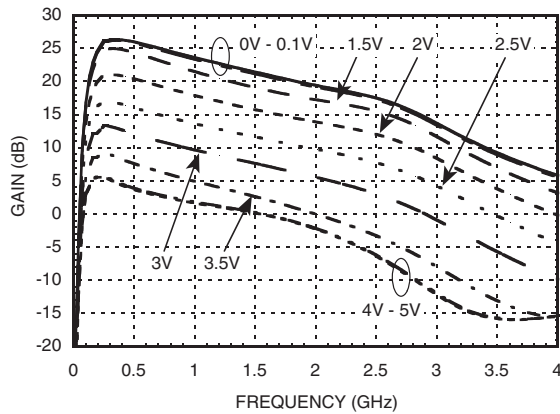

Gain vs. Control vs. Frequency, 2 Attenuators

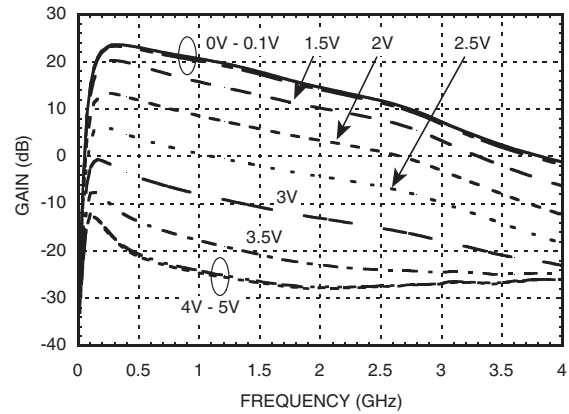

Maximum Gain, 1 Attenuator

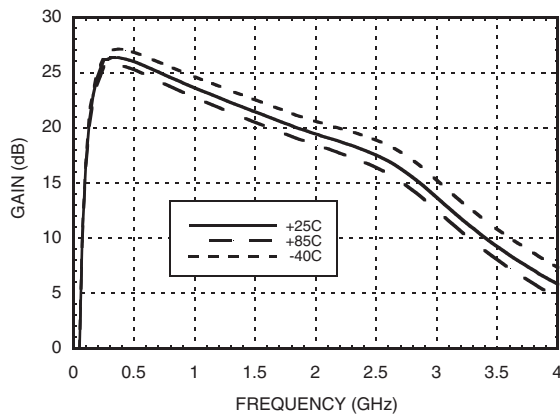

Maximum Gain, 2 Attenuators

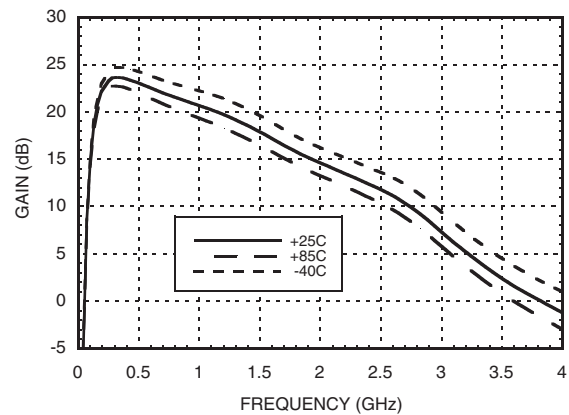

[1] Tested with broadband bias tee on RF ports and C1 = 10,000pF
[2] C1, C6 and C8 = 100pF, L1 = 24nF

For price, delivery, and to place orders, please contact Hittite Microwave Corporation:
20 Alpha Road, Chelmsford, MA 01824 Phone: 978-250-3343 Fax: 978-250-3373
Order On-line at www.hittite.com



**GaAs MMIC ANALOG VARIABLE
 GAIN AMPLIFIER, 0.4 - 3.0 GHz**

**Input Return Loss vs
 Control @ 900 MHz, 1 Attenuator**

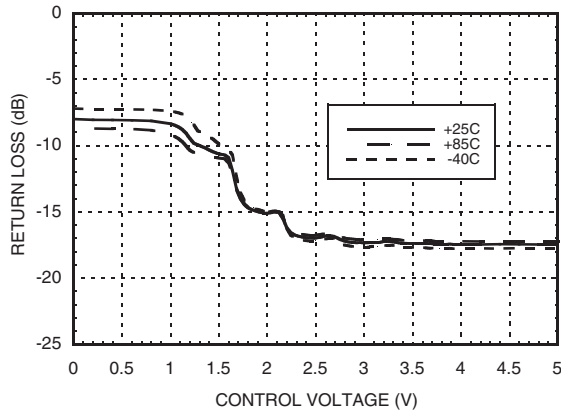

**Input Return Loss vs
 Control @ 900 MHz, 2 Attenuators**

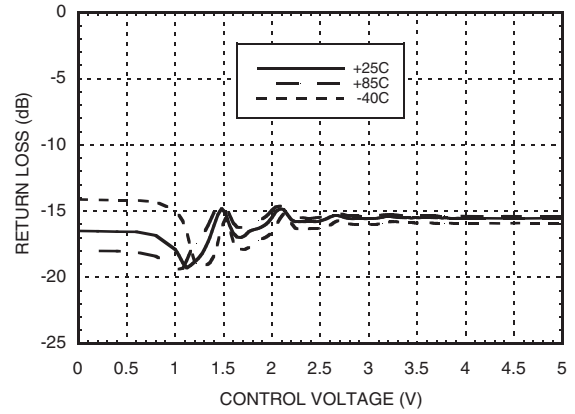

**Input Return Loss vs
 Control @ 1900 MHz, 1 Attenuator**

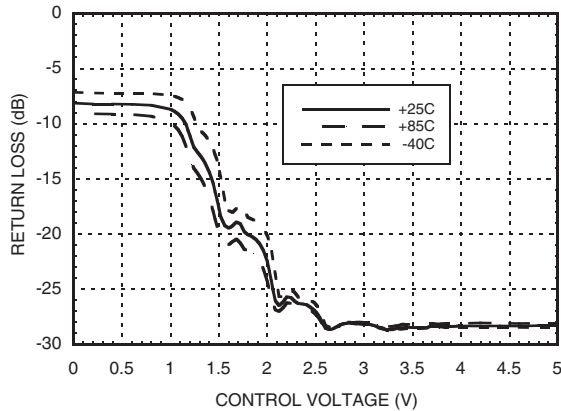

**Input Return Loss vs
 Control @ 1900 MHz, 2 Attenuators**

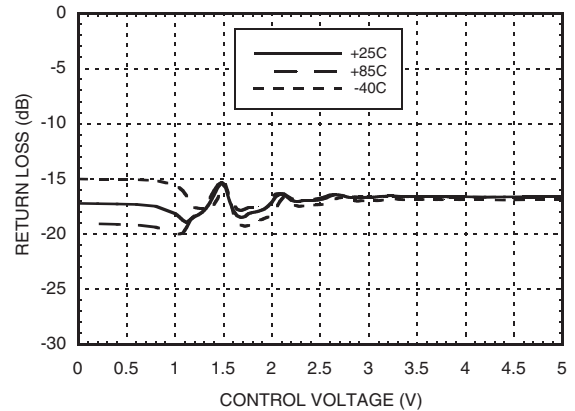

**Input Return Loss vs
 Control @ 2400 MHz, 1 Attenuator**

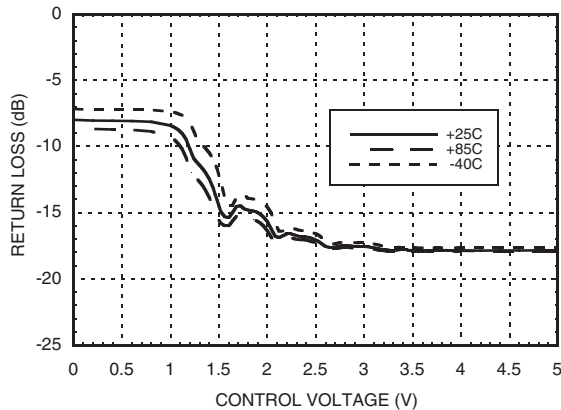

**Input Return Loss vs
 Control @ 2400 MHz, 2 Attenuators**

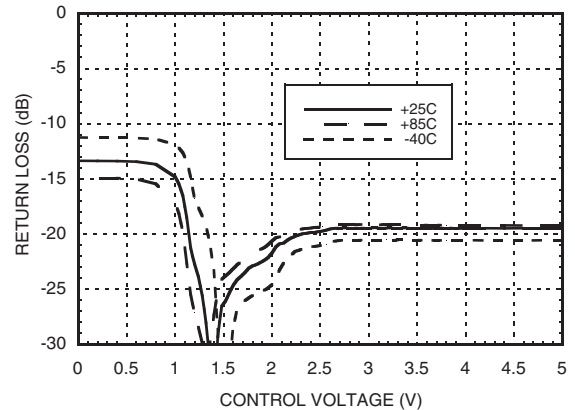



GaAs MMIC ANALOG VARIABLE GAIN AMPLIFIER, 0.4 - 3.0 GHz

Output Return Loss vs Control @ 900 MHz, 1 Attenuator

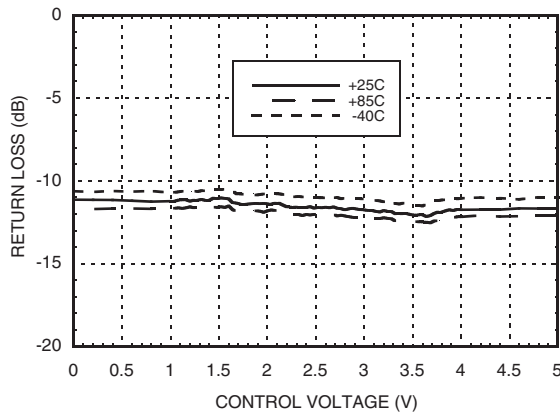

Output Return Loss vs Control @ 900 MHz, 2 Attenuators

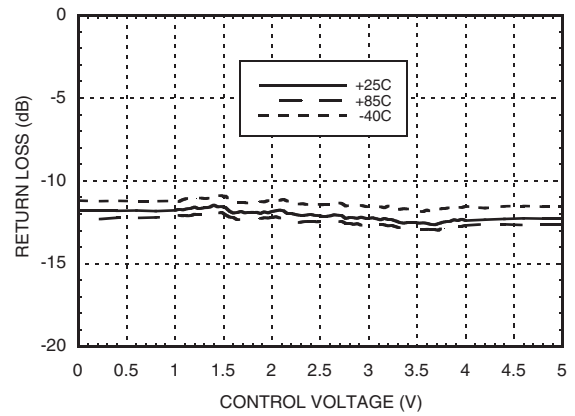

Output Return Loss vs Control @ 1900 MHz, 1 Attenuator

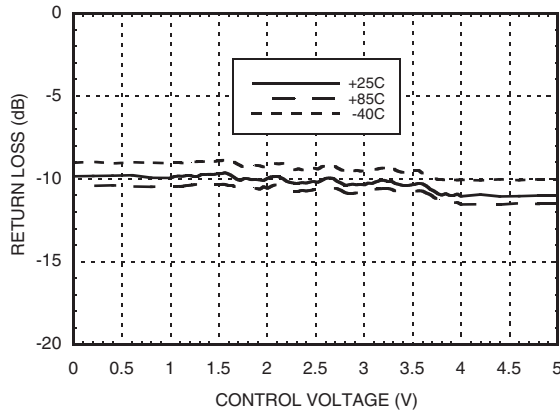

Output Return Loss vs Control @ 1900 MHz, 2 Attenuators

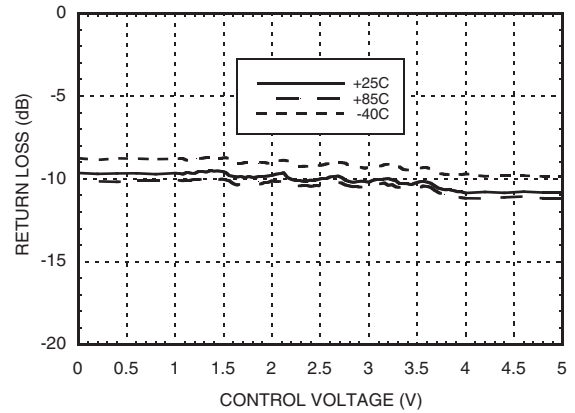

Output Return Loss vs Control @ 2400 MHz, 1 Attenuator

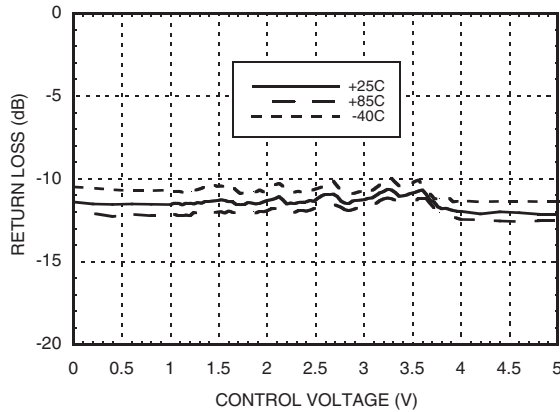

Output Return Loss vs Control @ 2400 MHz, 2 Attenuators

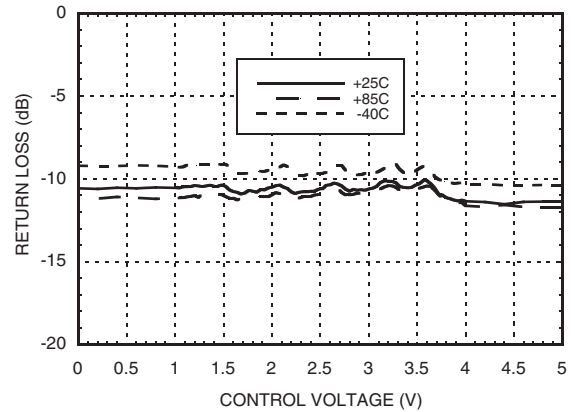

VARIABLE GAIN AMPLIFIERS - SMT



GaAs MMIC ANALOG VARIABLE GAIN AMPLIFIER, 0.4 - 3.0 GHz

Output IP3 vs. Control Voltage @ 900 MHz

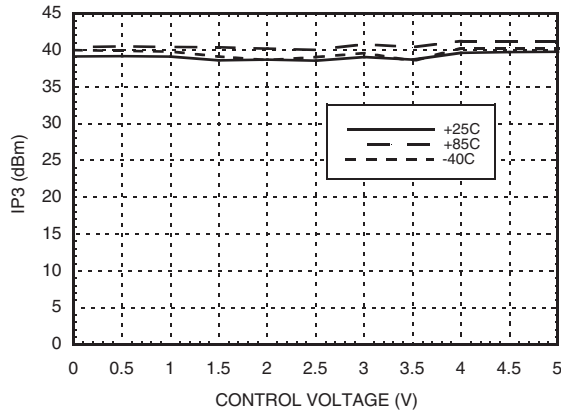

Output IP3 vs. Control Voltage @ 1900

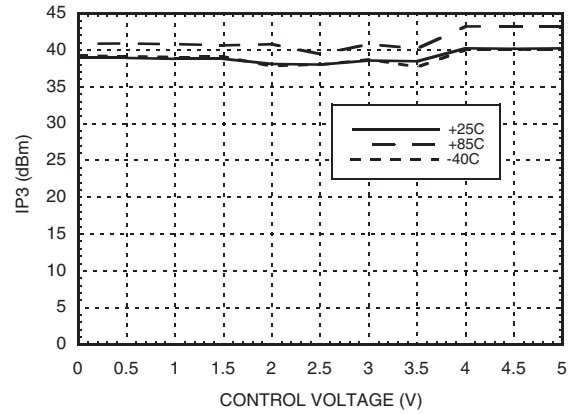

Output IP3 vs. Control Voltage @ 2400 MHz

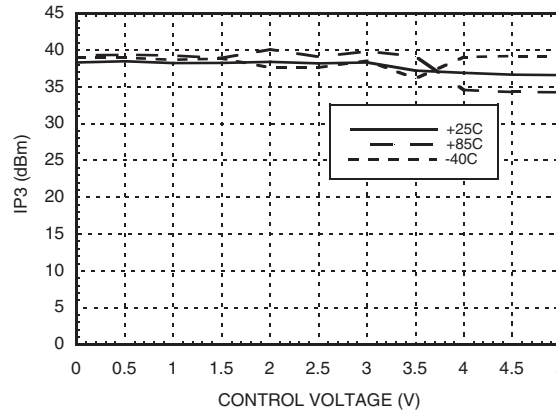

Absolute Maximum Ratings

Max. RF Input ^[1]	+20 dBm
Max. RF Input ^[2]	+10 dBm
Max Voltage	5.5 Vdc
Channel Temperature	150 °C
Continuous Pdiss (T = 85 °C) (derate 24.12 mW/°C above 85 °C) ^[1]	1.57 W
Thermal Resistance (Channel to Package Base)	41.45 °C/W
Storage Temperature	-65 to +150 °C
Operating Temperature	-40 to +85 °C

[1] At Vct1 = 5.0V
[2] At Vct1 = 0V

Bias Voltage

Vdd (Vdc)	Idd (Typ.) (mA)
+5V	265



**ELECTROSTATIC SENSITIVE DEVICE
OBSERVE HANDLING PRECAUTIONS**

Outline Drawing

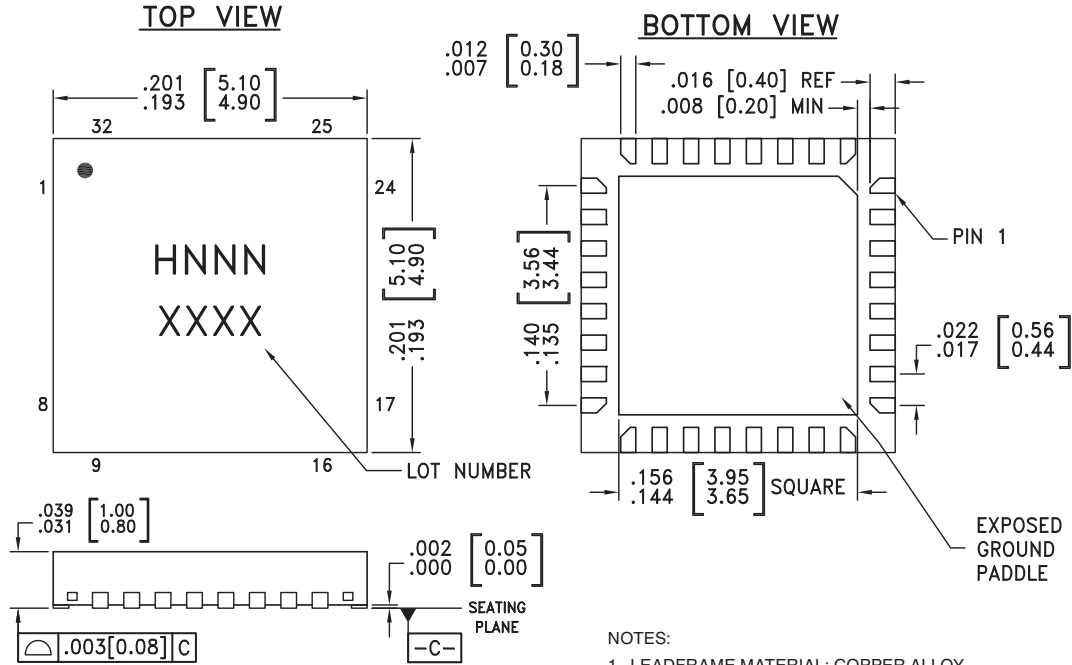

NOTES:

1. LEADFRAME MATERIAL: COPPER ALLOY
2. DIMENSIONS ARE IN INCHES [MILLIMETERS]
3. LEAD SPACING TOLERANCE IS NON-CUMULATIVE.
4. PAD BURR LENGTH SHALL BE 0.15mm MAXIMUM.
PAD BURR HEIGHT SHALL BE 0.05mm MAXIMUM.
5. PACKAGE WARP SHALL NOT EXCEED 0.05mm.
6. ALL GROUND LEADS AND GROUND PADDLE MUST BE SOLDERED TO PCB RF GROUND.
7. REFER TO HITTITE APPLICATION NOTE FOR SUGGESTED LAND PATTERN.

Package Information

Part Number	Package Body Material	Lead Finish	MSL Rating	Package Marking ^[3]
HMC640LP5	Low Stress Injection Molded Plastic	Sn/Pb Solder	MSL1 ^[1]	H640 XXXX
HMC640LP5E	RoHS-compliant Low Stress Injection Molded Plastic	100% matte Sn	MSL1 ^[2]	H640 XXXX

[1] Max peak reflow temperature of 235 °C
 [2] Max peak reflow temperature of 260 °C
 [3] 4-Digit lot number XXXX

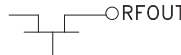
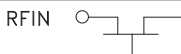
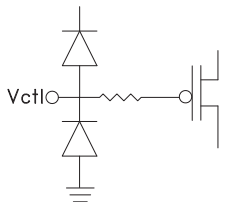
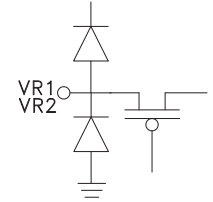
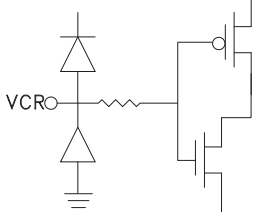
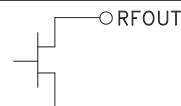
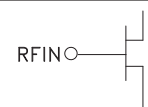
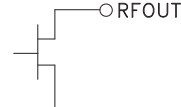
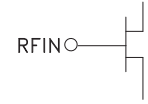

Pin Descriptions

Pin Number	Function	Description	Interface Schematic
1, 3, 5, 6, 8, 17, 21, 24, 25, 27, 29, 32	GND	These pins must be connected to RF ground.	
2	ATTOUT2	This port is matched to 50 Ohms. Blocking capacitor required.	
4, 10, 30	Vdd	Power Supply for the attenuator. External by pass capacitors are required. See application circuit.	
7	ATTIN2	This port is matched to 50 Ohms. Blocking capacitor required.	
9	Vctl	Attenuation control voltage for the attenuator. 0V for minimum attenuation, 5V for maximum attenuation.	
11, 12	VR1, VR2	External bias control voltages. Changes internal bias points of attenuator. No voltage applied for normal operation.	
13	VCR	External bias control voltage. For normal operation, set voltage low (0V). Setting the voltage high (5V) enables external control of the bias circuit via VR1 and VR2.	
14 - 16, 19, 23	N/C	No connection required. These pins may be connected to RF ground without affecting performance.	
18	AMPOUT2	This port is matched to 50 Ohms. External Choke inductor and DC blocking capacitor are required. See application circuit.	
20	AMPIN2	This port is matched to 50 Ohms. Blocking capacitor required.	
22	AMPOUT1	This port is matched to 50 Ohms. External Choke inductor and DC blocking capacitor are required. See application circuit.	
26	AMPIN1	This port is matched to 50 Ohms. Blocking capacitor required.	

Pin Descriptions

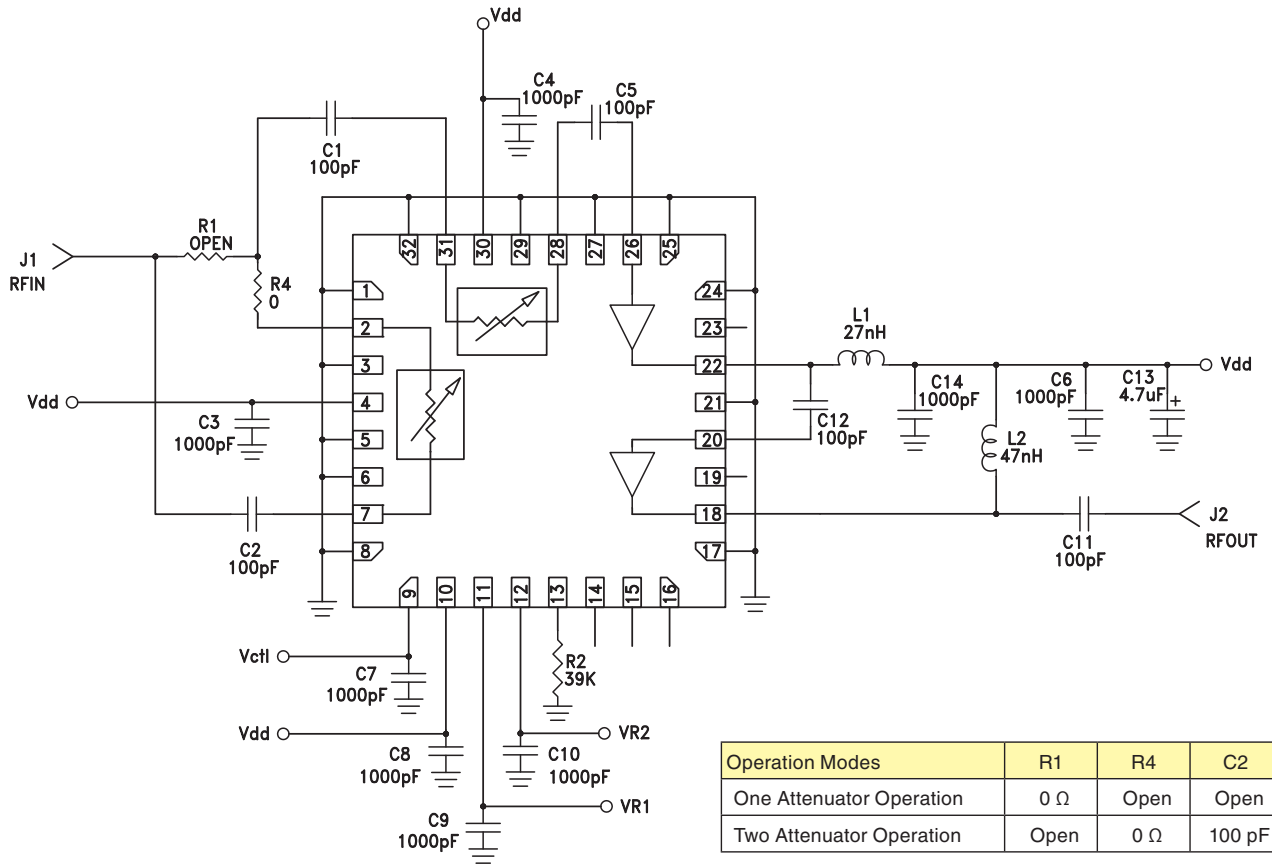
Pin Number	Function	Description	Interface Schematic
28	ATTOUT1	This port is matched to 50 Ohms. Blocking capacitor required.	
31	ATTIN1	This port is matched to 50 Ohms. Blocking capacitor required.	

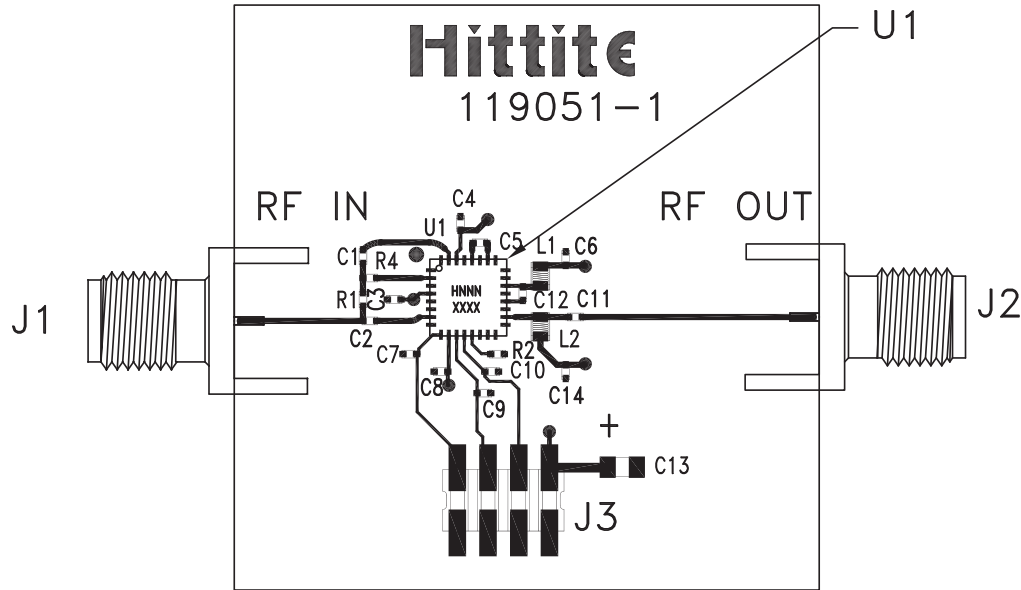
Application Circuit (Two Attenuator Operation)

Evaluation PCB - One or Two Attenuator Operations

List of Materials for Evaluation PCB 119053 [1][4]

Item	Description
J1 - J2	PCB Mount SMA RF Connector
J3	DC Connector Header
C1, C2, C5, C11, C12	100 pF Capacitor, 0402 Pkg ^[3]
C3, C4, C6 - C10, C14	1000 pF Capacitor, 0402 Pkg.
C13	4.7 μ F Tantalum 0805 Pkg.
L1	27 nH Inductor 0603 Pkg.
L2	47 nH Inductor 0603 Pkg.
R4	0 Ω Resistor 0402 ^[3] Pkg.
R2	39k Ω Resistor 0402 Pkg.
U1	HMC640LP5(E) Variable Gain Amplifier
PCB [2]	119051 Evaluation PCB

[1] Reference this number when ordering complete evaluation PCB

[2] Circuit Board Material: Rogers 4350

[3] See Application Circuit "Operation Modes" Table

[4] List of material reflects two attenuator operation, R1 not used

The circuit board used in the final application should use RF circuit design techniques. Signal lines should have 50 ohm impedance while the package ground leads and exposed paddle should be connected directly to the ground plane similar to that shown. A sufficient number of via holes should be used to connect the top and bottom ground planes. The evaluation circuit board shown is available from Hittite upon request.