



## 1 dB LSB GaAs IC 5-BIT DIGITAL ATTENUATOR, 0.7 - 2.7 GHz

### Typical Applications

The HMC274QS16 / HMC274QS16E is ideal for:

- Cellular/PCS/3G Infrastructure
- 2.4 GHz ISM Radios
- Wireless Data

### Features

- 1 dB LSB Steps to 31 dB
- Single Positive Control (+3 to +5V) Per Bit
- ±0.5 dB Typical Bit Error
- Small QSOP16 Plastic Package
- Included in the HMC-DK004 Designer's Kit

### Functional Diagram

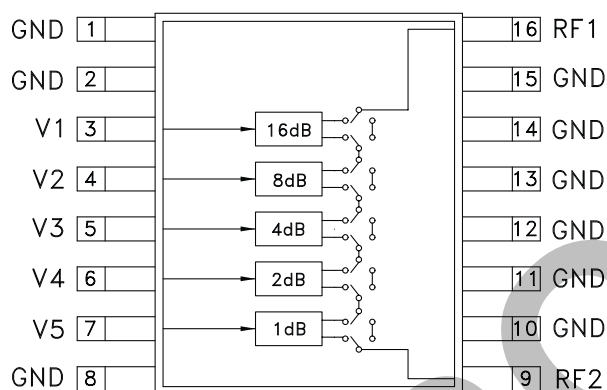

### General Description

The HMC274QS16 & HMC274QS16E are broadband 5-bit positive control GaAs IC digital attenuators in 16 lead QSOP plastic packages. Covering 0.7 to 2.7 GHz the insertion loss is typically less than 2.3 dB. The attenuator bit values are 1 (LSB), 2, 4, 8, and 16 dB for a total attenuation of 31 dB. Accuracy is excellent at ± 0.5 dB typical with an IIP3 of up to +50 dBm. Five bit control voltage inputs, toggled between 0 and +3 to +5 volts, are used to select each attenuation state. A single Vdd bias of +3 to +5 volts applied through an external 5K Ohm resistor is required.

### Electrical Specifications, $T_A = +25^\circ C$ , $V_{dd} = +3V$ to $+5V$ & $V_{ctl} = 0/V_{dd}$

Parameter	Frequency	Min.	Typical	Max.	Units
Insertion Loss	0.7 - 1.4 GHz		2.0	2.4	dB
	1.4 - 2.3 GHz		2.3	2.7	dB
	2.3 - 2.7 GHz		2.5	3.1	dB
Attenuation Range	0.7 - 2.7 GHz		31		dB
Return Loss (RF1 & RF2, All Atten. States)	0.7 - 1.4 GHz	10	15		dB
	1.4 - 2.7 GHz	12	17		dB
Attenuation Accuracy: (Referenced to Insertion Loss)					
All Attenuation States	0.7 - 1.4 GHz	± 0.35 + 5% of Atten. Setting Max			dB
All Attenuation States	1.4 - 2.3 GHz	± 0.25 + 3% of Atten. Setting Max			dB
All Attenuation States	2.3 - 2.7 GHz	± 0.30 + 5% of Atten. Setting Max			dB
Input Power for 0.1 dB Compression	0.7 - 2.7 GHz	Vdd = 5V	29		dBm
		Vdd = 3V	20		dBm
Input Third Order Intercept Point (Two-tone Input Power = 0 dBm Each Tone)	0.7 - 2.7 GHz	Vdd = 5V	54		dBm
		Vdd = 3V	52		dBm
Switching Characteristics					
tRISE, tFALL (10/90% RF)	0.7 - 2.7 GHz		560		ns
tON, tOFF (50% CTL to 10/90% RF)			600		ns

Information furnished by Analog Devices is believed to be accurate and reliable. However, no responsibility is assumed by Analog Devices for its use, nor for any infringements of patents or other rights of third parties that may result from its use. Specifications subject to change without notice. No license is granted by implication or otherwise under any patent or patent rights of Analog Devices. Trademarks and registered trademarks are the property of their respective owners.

For price, delivery, and to place orders: Analog Devices, Inc., One Technology Way, P.O. Box 9106, Norwood, MA 02062-9106 Phone: 781-329-4700 • Order online at [www.analog.com](http://www.analog.com) Application Support: Phone: 1-800-ANALOG-D



# HMC274QS16 / 274QS16E

## 1 dB LSB GaAs IC 5-BIT DIGITAL ATTENUATOR, 0.7 - 2.7 GHz

**Insertion Loss**

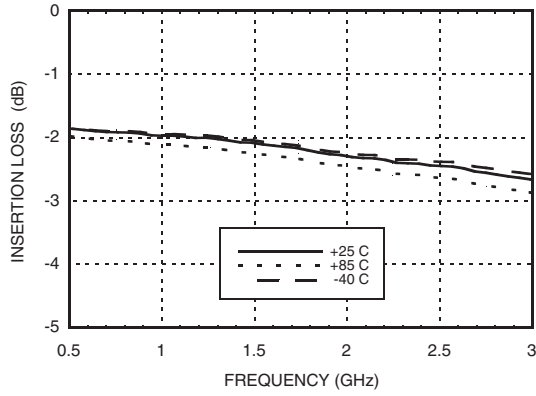

**Return Loss RF1, RF2**  
(Only Major States are Shown)

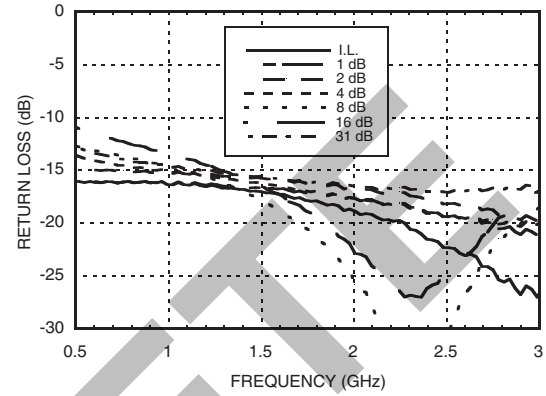

**Normalized Attenuation**  
(Only Major States are Shown)

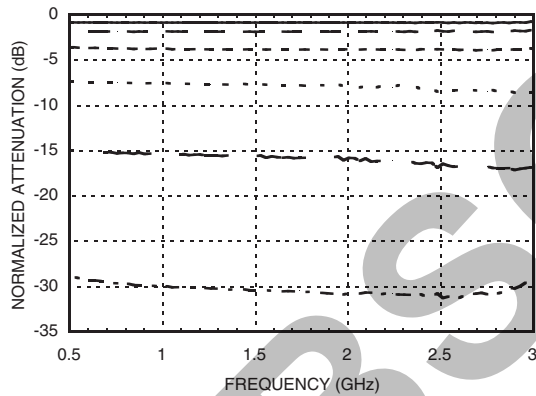

**Bit Error vs. Attenuation State**

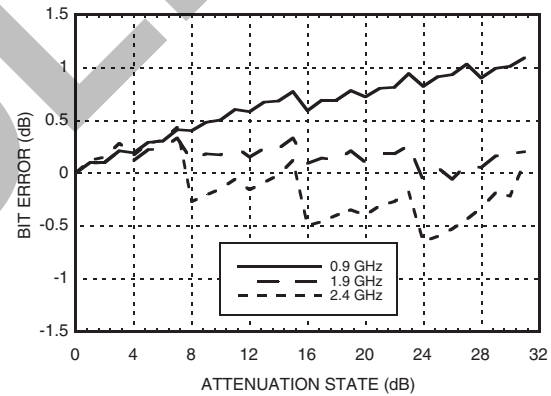

**Bit Error vs. Frequency**  
(Only Major States are Shown)

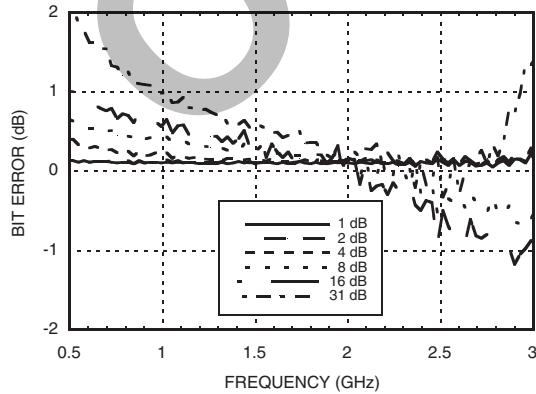

**Relative Phase vs. Frequency**  
(Only Major States are Shown)

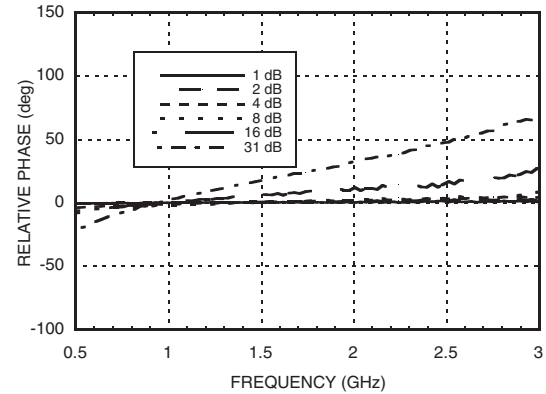

Note: All Data Typical Over Voltage (+3V to +5V).

Information furnished by Analog Devices is believed to be accurate and reliable. However, no responsibility is assumed by Analog Devices for its use, nor for any infringements of patents or other rights of third parties that may result from its use. Specifications subject to change without notice. No license is granted by implication or otherwise under any patent or patent rights of Analog Devices. Trademarks and registered trademarks are the property of their respective owners.

For price, delivery, and to place orders: Analog Devices, Inc., One Technology Way, P.O. Box 9106, Norwood, MA 02062-9106 Phone: 781-329-4700 • Order online at [www.analog.com](http://www.analog.com) Application Support: Phone: 1-800-ANALOG-D



### Compression Point & IP3

Attenuation State (dB)	Control Voltage (V)	Input P1dB (dBm)			Input P0.1dB (dBm)			Input IP3 (dBm)		
		+25C	+85C	-40C	+25C	+85C	-40C	+25C	+85C	-40C
1	5	32.3	31.8	32.9	29.4	28.8	29.8	54.7	49.1	52.2
2	5	32.3	31.8	32.8	29.2	28.6	29.4	52.2	49.1	52.2
4	5	32.8	32.1	33.3	29.4	28.7	29.3	54.1	48.65	52.7
1	3	24.8	25.7	25.2	19.7	18.6	21.1	52.2	48.1	52.5
2	3	24.7	24.1	25.1	19.7	18.3	21.0	52.2	48.1	52.2
4	3	26.0	25.6	26.6	19.6	18.6	21.1	53.1	47.65	53.2

### Application Circuit

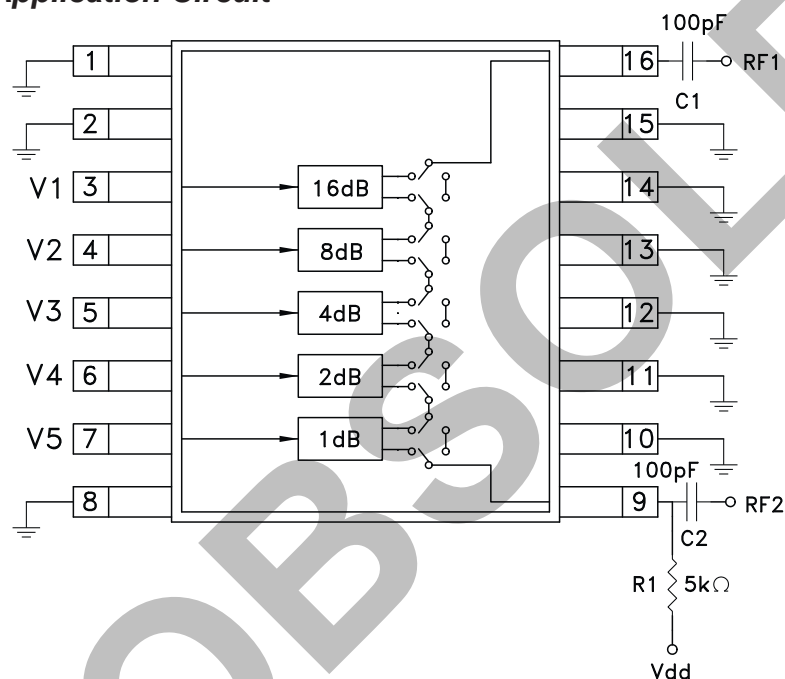

DC blocking capacitors C1 & C2 are required on RF1 & RF2. Choose C1 = C2 = 100 ~ 300 pF to allow lowest customer specific frequency to pass with minimal loss. R1 = 5K Ohm is required to supply voltage to the circuit through either PIN 9 or PIN 16.

### Truth Table

Control Voltage Input					Attenuation Setting RF1 - RF2
V1 16 dB	V2 8 dB	V3 4 dB	V4 2 dB	V5 1 dB	
High	High	High	High	High	Reference I.L.
High	High	High	High	Low	1 dB
High	High	High	Low	High	2 dB
High	High	Low	High	High	4 dB
High	Low	High	High	High	8 dB
Low	High	High	High	High	16 dB
Low	Low	Low	Low	Low	31 dB Max. Atten.

Any combination of the above states will provide an attenuation approximately equal to the sum of the bits selected.

## 1 dB LSB GaAs IC 5-BIT DIGITAL ATTENUATOR, 0.7 - 2.7 GHz



### Absolute Maximum Ratings

Control Voltage (V1 - V5)	Vdd + 0.5 Vdc
Bias Voltage (Vdd)	+8.0 Vdc
Storage Temperature	-65 to +150 °C
Operating Temperature	-40 to +85 °C
RF Input Power (0.7 - 2.7 GHz)	+30 dBm

### Control Voltages

State	Bias Condition
Low	0 to +0.2 V @ 20 uA Max
High	Vdd ± 0.2V @ 100 uA Max

Note: Vdd = +3V to 5V ± 0.2V



ELECTROSTATIC SENSITIVE DEVICE  
OBSERVE HANDLING PRECAUTIONS

### Outline Drawing

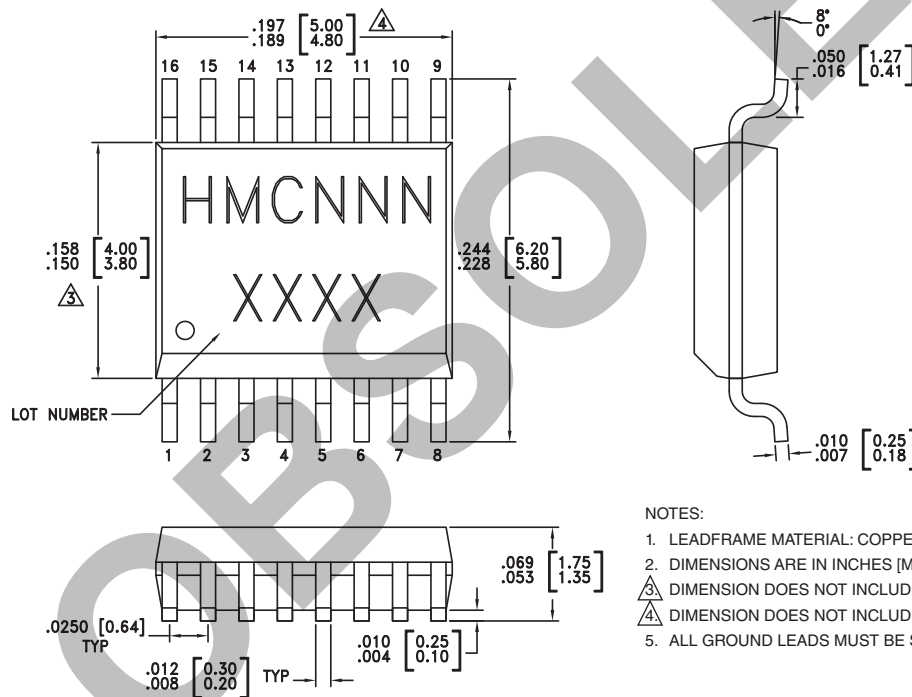

#### NOTES:

- LEADFRAME MATERIAL: COPPER ALLOY
- DIMENSIONS ARE IN INCHES [MILLIMETERS].
- DIMENSION DOES NOT INCLUDE MOLDFLASH OF 0.15mm PER SIDE.
- DIMENSION DOES NOT INCLUDE MOLDFLASH OF 0.25mm PER SIDE.
- ALL GROUND LEADS MUST BE SOLDERED TO PCB RF GROUND.

### Package Information

Part Number	Package Body Material	Lead Finish	MSL Rating	Package Marking <sup>[3]</sup>
HMC274QS16	Low Stress Injection Molded Plastic	Sn/Pb Solder	MSL1 <sup>[1]</sup>	HMC274 XXXX
HMC274QS16E	RoHS-compliant Low Stress Injection Molded Plastic	100% matte Sn	MSL1 <sup>[2]</sup>	HMC274 XXXX

[1] Max peak reflow temperature of 235 °C

[2] Max peak reflow temperature of 260 °C

[3] 4-Digit lot number XXXX

Information furnished by Analog Devices is believed to be accurate and reliable. However, no responsibility is assumed by Analog Devices for its use, nor for any infringements of patents or other rights of third parties that may result from its use. Specifications subject to change without notice. No license is granted by implication or otherwise under any patent or patent rights of Analog Devices. Trademarks and registered trademarks are the property of their respective owners.

For price, delivery, and to place orders: Analog Devices, Inc., One Technology Way, P.O. Box 9106, Norwood, MA 02062-9106  
Phone: 781-329-4700 • Order online at [www.analog.com](http://www.analog.com)  
Application Support: Phone: 1-800-ANALOG-D

**Pin Descriptions**

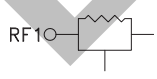
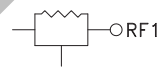
Pin Number	Function	Description	Interface Schematic
1, 2, 8, 10 - 15	GND	This pin must be DC grounded.	
3 - 7	V1 - V5	See truth table and control voltage table.	
9	RF1	This pin is DC coupled and matched to 50 Ohm. Blocking capacitors are required.	
16	RF1	This pin is DC coupled and matched to 50 Ohm. Blocking capacitors are required.	

**Evaluation PCB**

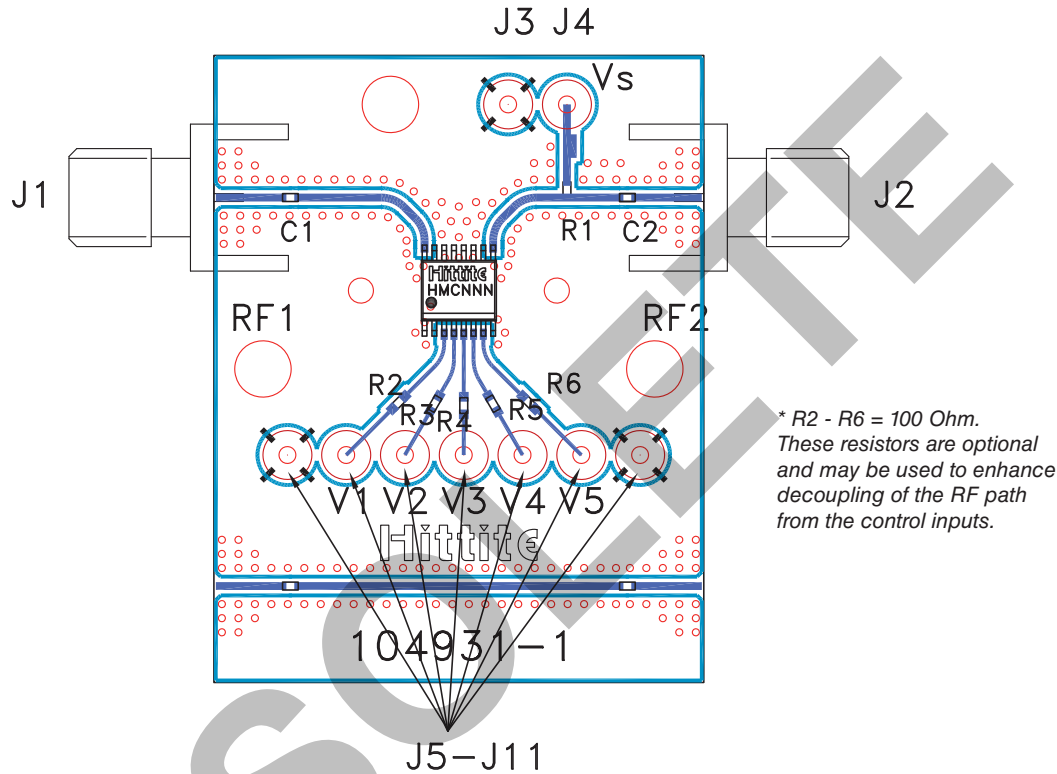

**List of Materials for Evaluation PCB 104976 [1]**

Item	Description
J1 - J2	PCB Mount SMA Connector
J3 - J11	DC Pin
R1	5k Ohm Resistor, 0402 Chip
R2 - R6	100 Ohm Resistor, 0402 Chip
C1, C2	0402 Chip Capacitor, Select for Lowest Frequency of Operation
U1	HMC274QS16 / HMC274QS16E Digital Attenuator
PCB [2]	104931 Evaluation PCB

[1] Reference this number when ordering complete evaluation PCB

[2] Circuit Board Material: Rogers 4350

The circuit board used in the final application should use RF circuit design techniques. Signal lines should have 50 ohm impedance while the package ground leads should be connected directly to the ground plane similar to that shown below. A sufficient number of via holes should be used to connect the top and bottom ground planes. The evaluation circuit board as shown is available from Hittite Microwave Corporation upon request.