

REV.	ECN NO.	DATE	SIGN	DESCRIPTION
C	LEN-930835	2009/03/12	Doreen	Change plastic in the notes.
D	LE31340003	2013/03/20	Rita	Update drawing
E	LEN15A0272	2015/10/01	Ruru	Change Logo

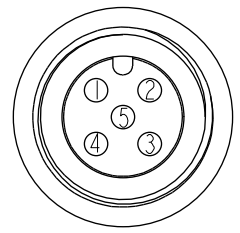

Conn.1&2&3&4&5
Pin Assignments
Front View

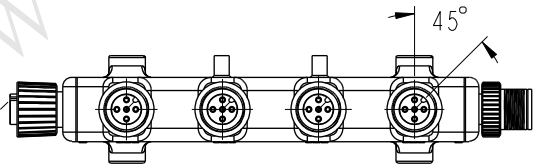
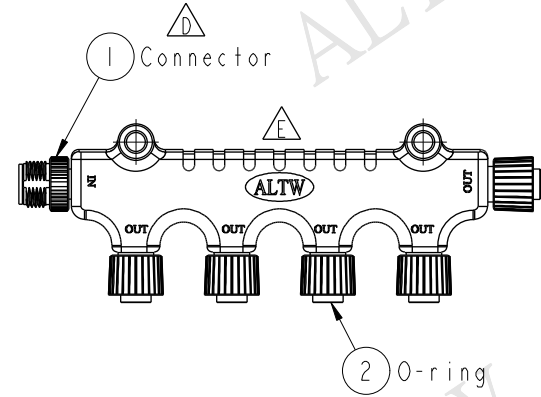
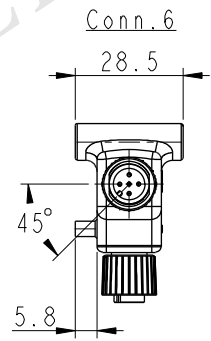
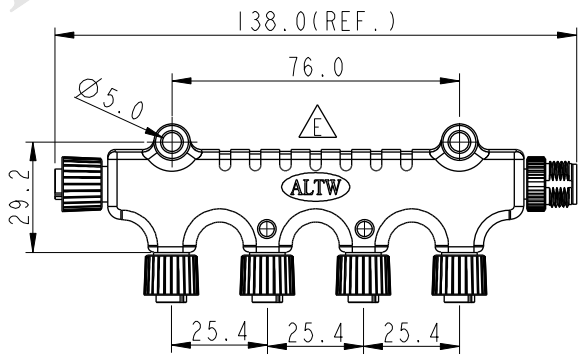
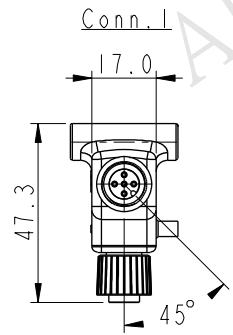
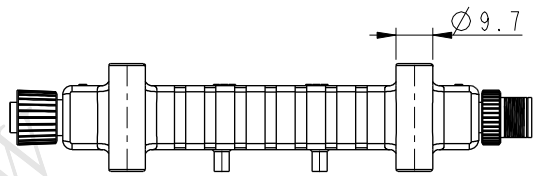
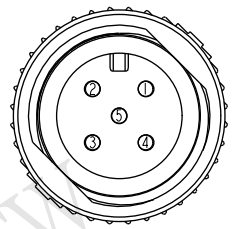

Conn.6
Pin Assignments
Front View

Blue 藍 (22AWG)	5	5
White 白 (22AWG)	4	4
Black 黑 (22AWG)	3	3
Red 紅 (22AWG)	2	2
Green 綠 (22AWG)	1	1
Wire Color	Conn.1	Conn.6
	Pin Out	

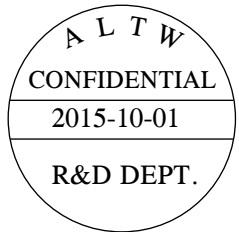

- Note:
- * (QC) Important Dimension.
 - * Waterproof Rate: IP68.
 - * Connector: NY+GF, PU, Black.
 - * Nut: Zinc Alloy, Nickel Plated.
 - * Pin: Copper Alloy, Gold Plated.
 - * Wire Harness: UL1007/TR64 22AWG, OD=0.76mm, Green, White, Blue, Red, Black
 - * Text Depth: 0.3 mm

UNIT: mm		
TOLERANCE	.X ±0.25	
.XX ±0.1		
.XXX ±0.05		
ANGLES	±1°	

TITLE NMEA2000 MICRO-C 4-WAY TEE			
SCALE 1:2	SIZE A4	SHEET 1 OF 1	
REV. E	WC-REV. A.1	(QC) Inspection item	

Amphenol LTW
安費諾亮泰企業股份有限公司

ITEM NO. S-555555-FFFFF-S001	DRAWN BY Ruru	DATE 2015-10-01
DWG NO. S-555555-FFFFF-S001	CHECKED BY Rita	DATE 2015-10-01
CUSTOMER ALTW	APPROVED BY Lisa	DATE 2015-10-01

THIS DOCUMENT IS SUBJECT TO CHANGE WITHOUT NOTICE. IT IS CONFIDENTIAL AND A PROPERTY OF AMPHENOL LTW. DISCLOSURE TO THIRD PARTY HAS TO BE AUTHORIZED BY AMPHENOL LTW.