

REV.	ECN NO.	DATE	SIGN	DESCRIPTION
A	Initial Release	2015-07-25	Feng_Li	Change Rev.01 To Rev.A
B	LEN1750140	2017-04-06	Lingpeng	Change The Cable OD
C		2019-01-21	Ruru	Modify The Waterproof Rating

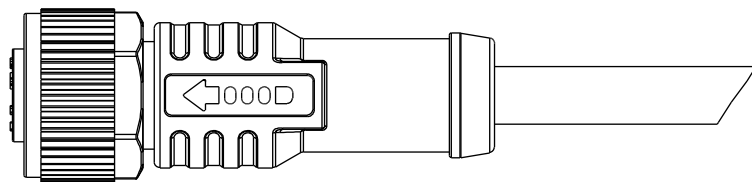
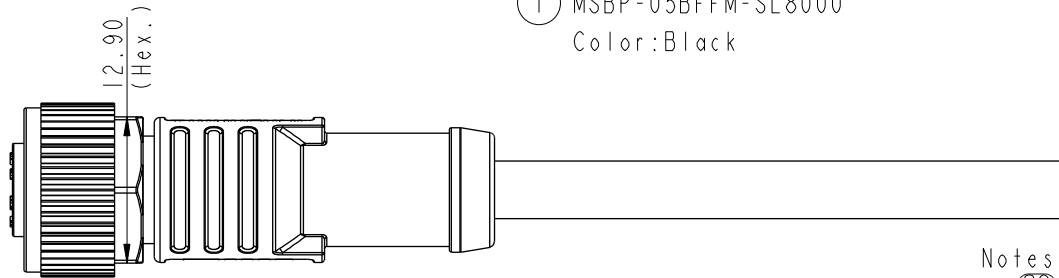
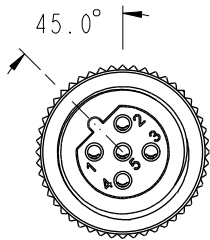
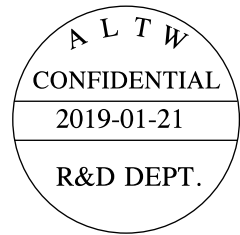
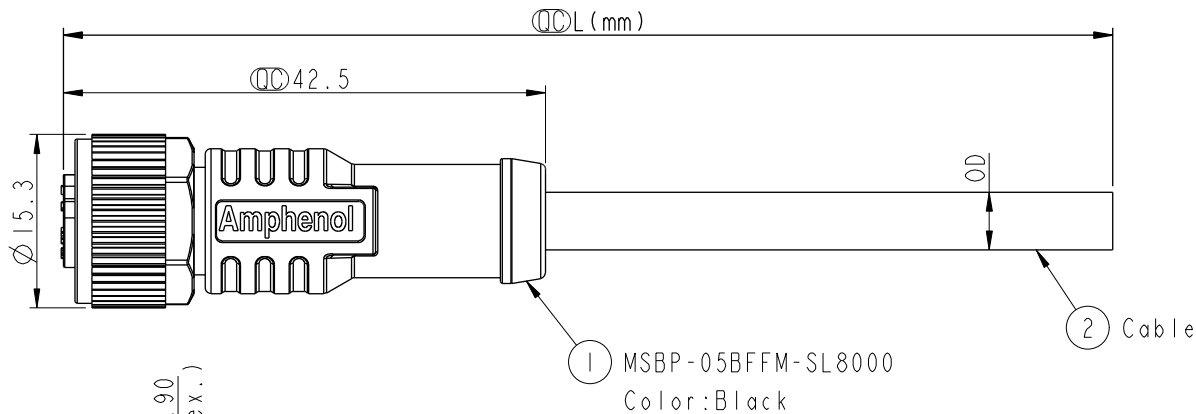

- Notes:
- \*  $\varnothing$  Important Dimension.
  - \*  $\triangle$  Waterproof Rate: IP68, IP69K.
  - \* Connector: PU+GF, Black.
  - \* Female Pin: Copper Alloy, Gold Plated.
  - \* Screw Nut: Nylon, Black.
  - \* Outer Mold: PU, Black.
  - \* Cable: (A) UL2517, PVC Jacket, Yellow.  
(B) UL20549, PUR Jacket, Black.  
(D) UL2517, PVC Jacket, Black.
  - \* Rated Voltage: 60V dc. or ac.
  - \* Rated Current: 4A
  - \* Operating Temperature: -25~85°C
  - \* Cable Length Tolerance: 01M: ±40mm  
02M~05M: ±60mm  
06M~10M: ±100mm  
11M~30M: ±200mm  
31M~99M: ±500mm

UNIT:mm		
TOLERANCE		
±0.5mm		

TITLE M12 B Type Cable Female Conn.			
SCALE 1:1	SIZE A4	SHEET 1 OF 2	
REV. C	WC-REV. A.2	$\varnothing$ : Inspection item	

**Amphenol LTW**  
安費諾亮泰企業股份有限公司

ITEM NO	DRAWN BY Ruru	DATE 2019-01-21
DWG NO MSBP-05BFFM-SL8XXX	CHECKED BY Rita	DATE 2019-01-21
CUSTOMER ALTW	APPROVED BY Max	DATE 2019-01-21

THIS DOCUMENT IS SUBJECT TO CHANGE WITHOUT NOTICE. IT IS CONFIDENTIAL AND A PROPERTY OF Amphenol LTW. DISCLOSURE TO THIRD PARTY HAS TO BE AUTHORIZED BY Amphenol LTW.

THIS DOCUMENT IS SUBJECT TO CHANGE WITHOUT NOTICE. IT IS CONFIDENTIAL AND A PROPERTY OF Amphenol LTW. DISCLOSURE TO THIRD PARTY HAS TO BE AUTHORIZED BY Amphenol LTW.

5P	PVC	5.1	22	MSBP-05BFFM-SL8DXX
5P	PUR	4.4	22	MSBP-05BFFM-SL8BXX
5P	PVC	5.1	22	MSBP-05BFFM-SL8AXX
Contacts	Cable Jacket	Cable OD	AWG	Item No.



M SBP - 05 B F F M - S L 8 X XX

SBP: B-Code Plastic Nut

05: 5Pin

B: Cable Without S/R(線端無網尾)

F: Female Connector(母座)

F: Female Pin(母Pin)

M: Molding Type(射出成型)

XX: 01~99Meters  
 01: 01Meter  
 02: 02Meters  
 .  
 99: 99Meters

A: PVC UL2517 Cable, Yellow(PVC黃色外被線材)  
 B: PUR UL20549 Cable, Black(PUR黑色外被線材)  
 D: PVC UL2517 Cable, Black(PVC黑色外被線材)

8: IP68/IP69K(防水等級68/69K)

L: Straight(180°線端)

S: Screw(螺紋式)

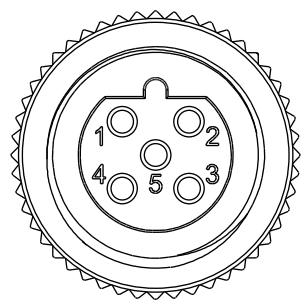

Pin Assignments  
Front View

5	Gray	灰
4	Black	黑
3	Blue	藍
2	White	白
1	Brown	棕
Conn.	Wire Color	
Pin Out		

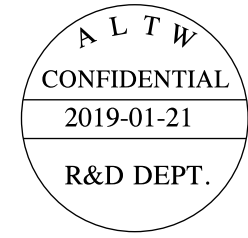

UNIT:mm		
TOLERANCE		
±0.5mm		

TITLE M12 B Type Cable Female Conn.			
SCALE 1:1	SIZE A4	SHEET 2 OF 2	
REV. C	WC-REV. A.2	QC: Inspection item	

**Amphenol LTW**  
安費諾亮泰企業股份有限公司

ITEM NO	DRAWN BY Ruru	DATE 2019-01-21
DWG NO MSBP-05BFFM-SL8XXX	CHECKED BY Rita	DATE 2019-01-21
CUSTOMER ALTW	APPROVED BY Max	DATE 2019-01-21