

Tous droits strictement reserves. Reproduction ou communication a des tiers interdite sous quelque forme que ce soit sans autorisation écrite du propriétaire. Propriete de c FCI. Droits de reproduction FCI.

FCI

All rights strictly reserved. Reproduction or issue to third parties in any form whatever is not permitted without written authority from the proprietor. Property of FCI. Copyright FCI.

PRODUCT NO	PORTS NO	DIA A ± 0.60 -0.00	DIM B	DIM C ± 0.10	DIM D ± 0.15	DIM E ± 0.13	GROUND LEG NUMBER ON THE BACK (VIEW B)
95676-X01 95676-X01N	1	15.74	-	5.715	11.43	16.16	SEE DIAGRAMS ON SHEET 3
95676-X02YZ 95676-X02NYZ	2	30.98	13.97	12.700	25.40	31.40	
95676-X03YZ 95676-X03NYZ	3	44.95	27.94	19.685	39.37	45.37	
95676-X04YZ 95676-X04NYZ	4	58.92	41.91	26.670	53.34	59.34	
95676-X05YZ 95676-X05NYZ	5	72.89	55.88	33.655	67.31	73.31	
95676-X06YZ 95676-X06NYZ	6	86.86	69.85	40.640	81.28	87.28	
95676-X07YZ 95676-X07NYZ	7	100.83	83.82	47.625	95.25	101.25	
95676-X08YZ 95676-X08NYZ	8	114.80	97.79	54.610	109.22	115.22	
95676-X09YZ 95676-X09NYZ	9	128.77	111.76	61.595	123.19	129.19	
95676-X10YZ 95676-X10NYZ	10	142.74	125.73	68.580	137.16	143.16	
95676-X11YZ 95676-X11NYZ	11	156.71	139.70	75.565	151.13	157.13	
95676-X12YZ 95676-X12NYZ LF	12	170.68	153.67	82.550	165.10	171.10	

NOTE 9

STATEMENT: "THIS PRODUCT MEETS THE REQUIREMENTS OF THE EUROPE UNION DIRECTIVE OF RESTRICTIONS FOR HAZARDOUS SUBSTANCES (DIRECTIVE 2002/95/EC) AND CAN BE PROCESSED IN THE PROCESS CONDITIONS FOR WHICH THE PRODUCT IS DEVELOPED. FCI, ITS SUBSIDIARIES AND AFFILIATES ("FCI") PROVIDES THE ABOVE DATA AND INFORMATION IN GOOD FAITH BASED UPON CURRENT KNOWLEDGE AND EXPERIENCE, BUT MAKE NO WARRANTY THAT SUCH DATA OR INFORMATION IS FREE FROM ERROR, IS COMPLETE OR IS SUFFICIENT FOR USER'S INTENDED PURPOSE EVEN IF MADE KNOWN TO FCI. FCI SPECIFICALLY DISCLAIMS ANY WARRANTY, EXPRESS OR IMPLIED, AND ASSUMES NO LIABILITY WITH RESPECT TO THE EFFECTIVENESS OR SAFETY OF THE PRODUCTS LISTED ABOVE. EACH USER MUST MAKE ITS OWN DETERMINATION AS TO THE SUITABILITY OF FCI'S PRODUCTS AND MATERIALS FOR ITS OWN PARTICULAR PURPOSE, AND MUST ASSURE THAT ITS PRODUCTS FABRICATE FROM FCI'S PRODUCTS AND MATERIALS ARE SAFE AND LAWFUL. IT IS THE USER'S RESPONSIBILITY TO ASSURE PROPER USE ABS DISPOSAL OF FCI'S PRODUCTS AND MATERIALS, THE SAFETY AND HEALTH OF USER'S EMPLOYEES AND CUSTOMER, AND USER'S COMPLIANCE WITH APPLICABLE LAWS AND REGULATIONS.."

NOTES:

1. RECOMMENDED P.C.B THICKNESS 1.60 MM.
2. HOUSING MAT'L: HIGH TEMP RESIN.
3. CONTACTS: PHOS BRONZE ALLOY UNS-C51000, ϕ 0.460 ROUND WIRE, PLATING SEE TABLE.

④ SHIELD MATL: BRASS ALLOY, .25 MM THICK. SHIELD PLATING:

- FOR 95676-X01 THRU 95676-X12YZ BRIGHT TIN LEAD, 100u"MIN OVER NICKEL.
- FOR 95676-X01N THRU 95676-X12NYZ NICKEL, 30u"MIN WITH SELECTIVE TIN LEAD ON SOLDER TAILS. SEE DETAIL E.
- FOR LEAD FREE 95676-X01 THRU 95676-X12YZ MATE TIN 80u" MIN. OVER 50u" NICKEL.
- FOR LEAD FREE 95676-X01N THRU 95676-X12NYZ WITH SELECTIVE MATTE TIN 80u" MIN. OVER 50u" NICKEL ON SOLDER TAILS. SEE DETAIL E.

5. THE HOUSING WITHSTAND EXPOSURE TO 260° PEAK TEMPERATURE FOR 15 SECONDS IN A WAVE SOLDER APPLICATION WITH A 1.5MM MINIMUM CIRCUIT BOARD. SEE APLICATION NOTES/PROCEDURES IF THEY ARE AVAILABLE.

6. PACKAGING MEETS FCI GS-14-920 SPECIFICATION FOR LEAD FREE AND RoHS LABELING.

⑦ SPECIALLY FOR ONE-POROT P/N 95676-X01 ONLY. SOLDER TAIL OF SHIELD IS 1.02 WIDE, DISTANCE FROM PCB PEG TO THE SOLDER TAIL IS 3.05.

8. ALL DIMENSIONS IN MILLIMETER.

PLATING CODE X	PLATING
0	30u" G.X.T.
1	15u" GOLD.
3	30u" GOLD.
5	50u" GOLD.

FRONT SHIELD CODE Y
0 = STANDARD GRND. TABS
1 = NO GRND. TABS

REAR SHIELD CODE Z
0 = STANDARD GRND. LEGS
1 = 1 STANDARD GRND. LEG
2 = ALL GRND. LEGS
3 = NO GRND. LEGS

ADD "LF" FOR LEAD FREE OPTION SEE NOTES 4 & 5

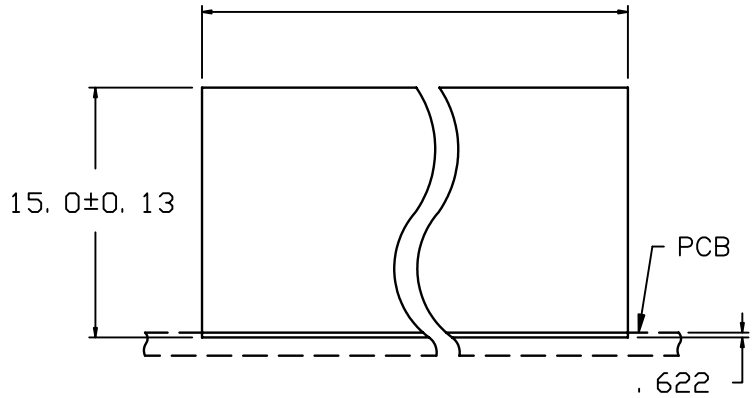

RECOMMENDED PANEL OPENING

mat'l. code				tolerances unless otherwise specified		CUSTOMER COPY		 www.fciconnect.com	
ltr	ecn no	dr	date	linear	.X \pm .3		projection	title	
M	N04-0043	zc	10/8/04		.XX \pm .10			R/A CAT 5 GANG JACK ASSY	
					.XXX \pm .050			8 POS SHIELDED DIAMOND PEG	
				angles	0° \pm 2°		 MM	product family MOD JACK	
				dr	L.POTTEIGER	1/30/03		code	
				enrg	J.KONTOS	1/30/03		213	
				chr	J.KONTOS	1/30/03	scale	sheet	
				appd	J.KONTOS	1/30/03		2 of 7	
sheet index	revision sheet						A4		95676

REAR SHIELD (VIEWED FROM PLUG ENTRY SIDE) GROUND SOLDERTAIL CONFIGURATION

CODE "Z" = 0

CODE "Z" = 1

CODE "Z" = 2

CODE "Z" = 3

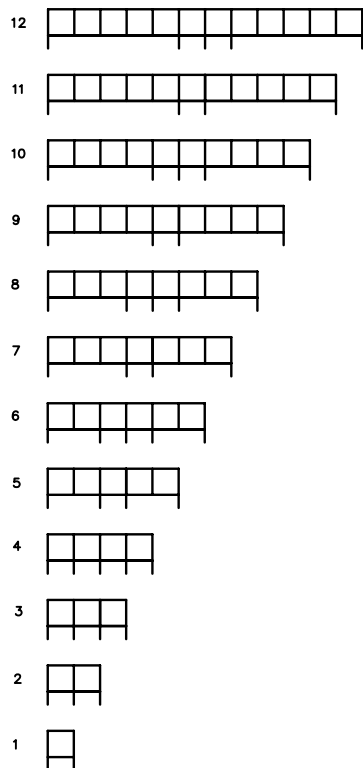

PCB LAYOUT SHEET 4

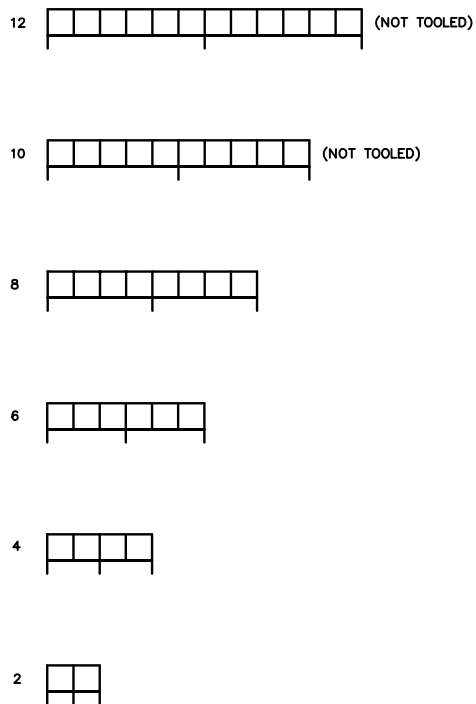

PCB LAYOUT SHEET 5

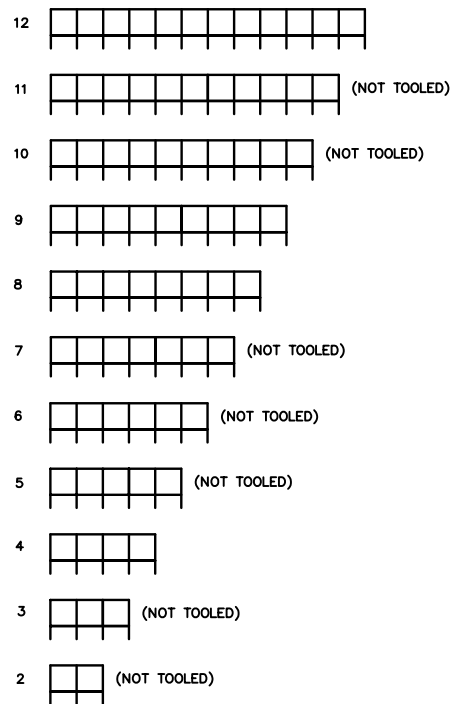

PCB LAYOUT SHEET 6

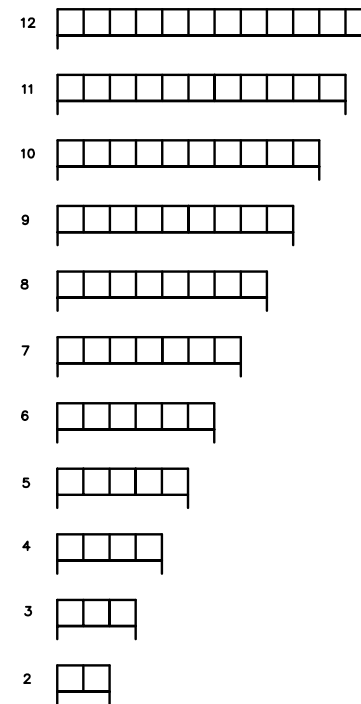

PCB LAYOUT SHEET 7

Tous droits strictement reserves. Reproduction ou communication a des tiers interdite sous quelque forme que ce soit sans autorisation ecrite du proprietaire. Propriete de c FCI. Droits de reproduction FCI.



All rights strictly reserved. Reproduction or issue to third parties in any form whatever is not permitted without written authority from the proprietor. Property of FCI. Copyright FCI.

mat'l. code				tolerances unless otherwise specified			CUSTOMER COPY	 www.fciconnect.com
ltr	ecn no	dr	date	linear	.X ±.3			
M	N04-0043	ZC	10/8/04		.XX ±.10			
					.XXX ±.050			
				angles	0° ±2°		 MM	
				dr	L.POTTEIGER	1/30/03		
				enr	J.KONTOS	1/30/03	title R/A CAT 5 GANG JACK ASSY 8 POS SHIELDED DIAMOND PEG product family MOD JACK size dwg no A4 95676	
				chr	J.KONTOS	1/30/03		
				appd	J.KONTOS	1/30/03		
sheet index	revision sheet						code 213	
							sheet 3 of 7	

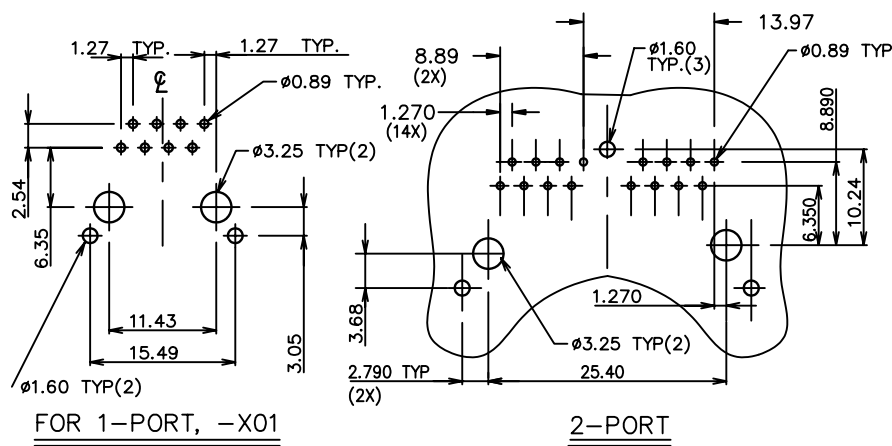
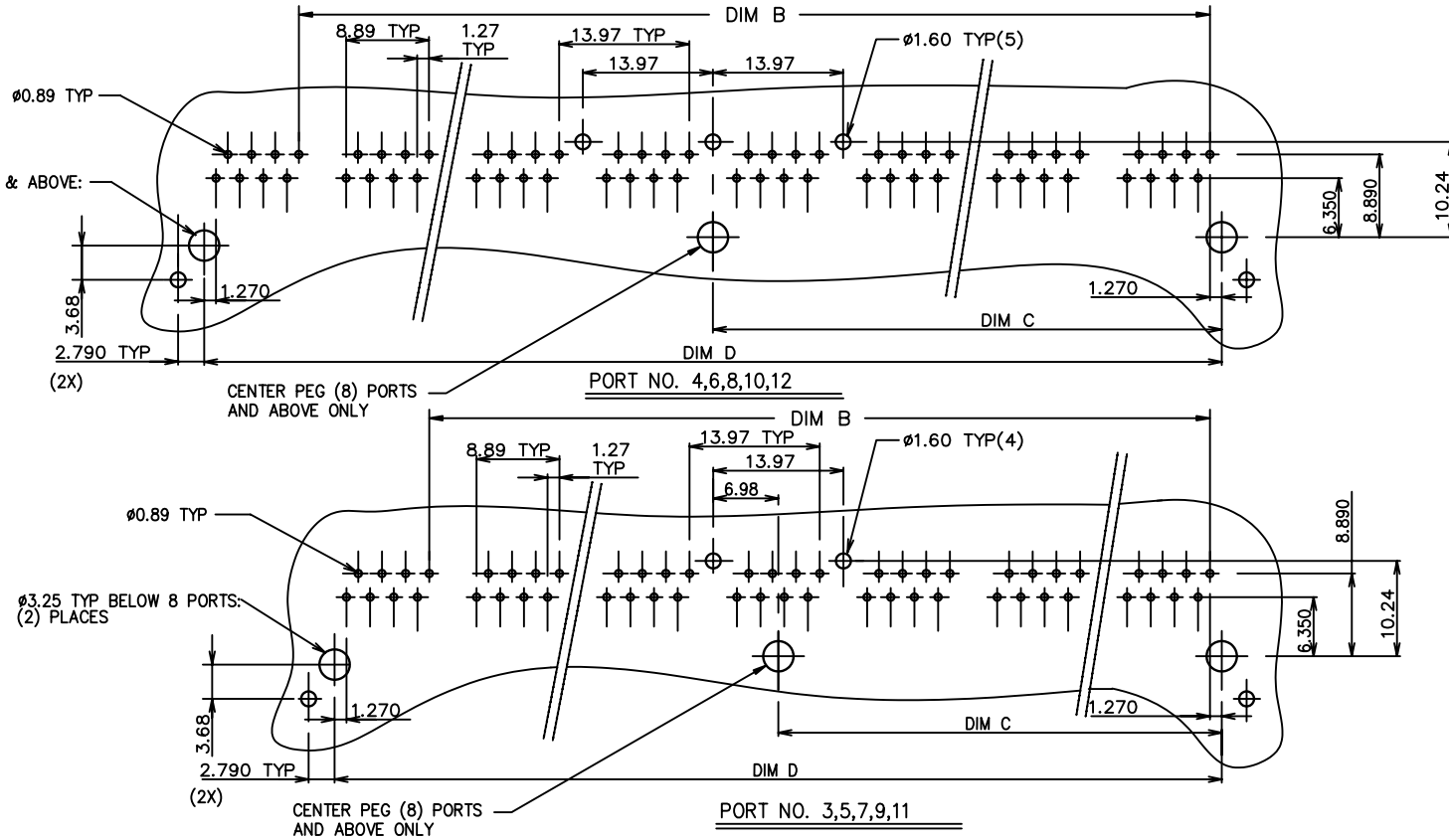

RECOMMENDED P.C.B LAYOUT

CODE "Z" = 0 (STANDARD GROUND LEGS)

mat'l. code				tolerances unless otherwise specified		CUSTOMER COPY		 www.fciconnect.com			
ltr	ecn no	dr	date	linear	.X ±.3	projection		title			
M	N04-0043	ZC	10/8/04		.XX ±.10			R/A CAT 5 GANG JACK ASSY		code	
					.XXX ±.050			8 POS SHIELDED DIAMOND PEG		213	
				angles	0° ±2°	MM		product family	MOD JACK	code	
				dr	L.POTTEIGER	1/30/03	scale	size		213	
				enr	J.KONTOS	1/30/03		dwg no		sheet	
				chr	J.KONTOS	1/30/03		A4		4 of 7	
				appd	J.KONTOS	1/30/03		95676			
sheet index	revision sheet					1:1					

Tous droits strictement reserves. Reproduction ou communication a des tiers interdite sous quelque forme que ce soit sans autorisation ecrite du proprietaire. Propriete de c FCI. Droits de reproduction FCI.

All rights strictly reserved. Reproduction or issue to third parties in any form whatever is not permitted without written authority from the proprietor. Property of FCI. Copyright FCI.

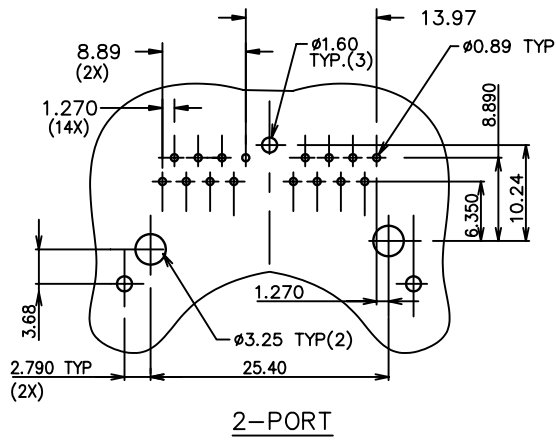
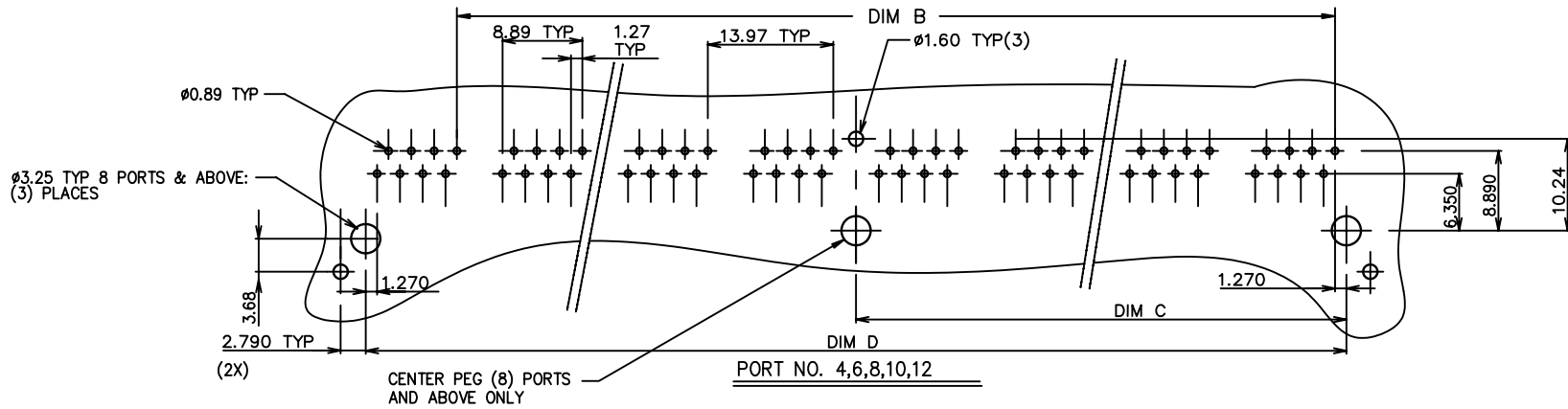

RECOMMENDED P.C.B LAYOUT

CODE "Z" = 1 (1 GROUND LEG)

mat'l. code				tolerances unless otherwise specified		CUSTOMER COPY		www.fciconnect.com			
ltr	ecn no	dr	date	linear	.X ±.3	projection		title			
M	N04-0043	ZC	10/8/04		.XX ±.10			R/A CAT 5 GANG JACK ASSY		code	
					.XXX ±.050			8 POS SHIELDED DIAMOND PEG		213	
				angles	0° ±2°	 MM 1:1	product family		code		
				dr	L.POTTEIGER		1/30/03	MOD JACK		213	
				enr	J.KONTOS		1/30/03	size		dwg no	
				chr	J.KONTOS		1/30/03	A4		95676	
				appd	J.KONTOS	1/30/03			sheet		
sheet	revision								5 of 7		
index	sheet										

Tous droits strictement reserves. Reproduction ou communication a des tiers interdite sous quelque forme que ce soit sans autorisation écrite du propriétaire. Propriete de c FCI. Droits de reproduction FCI.

All rights strictly reserved. Reproduction or issue to third parties in any form whatever is not permitted without written authority from the proprietor. Property of FCI. Copyright FCI.

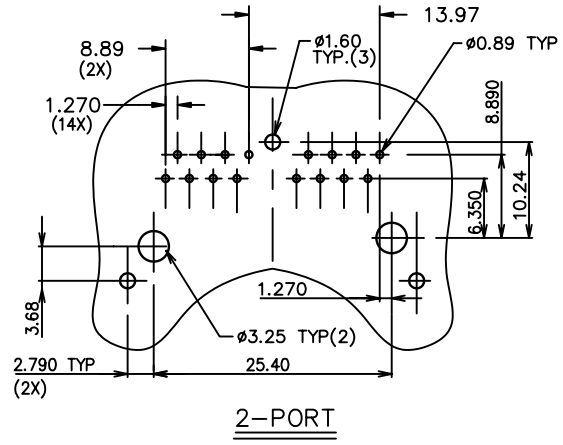
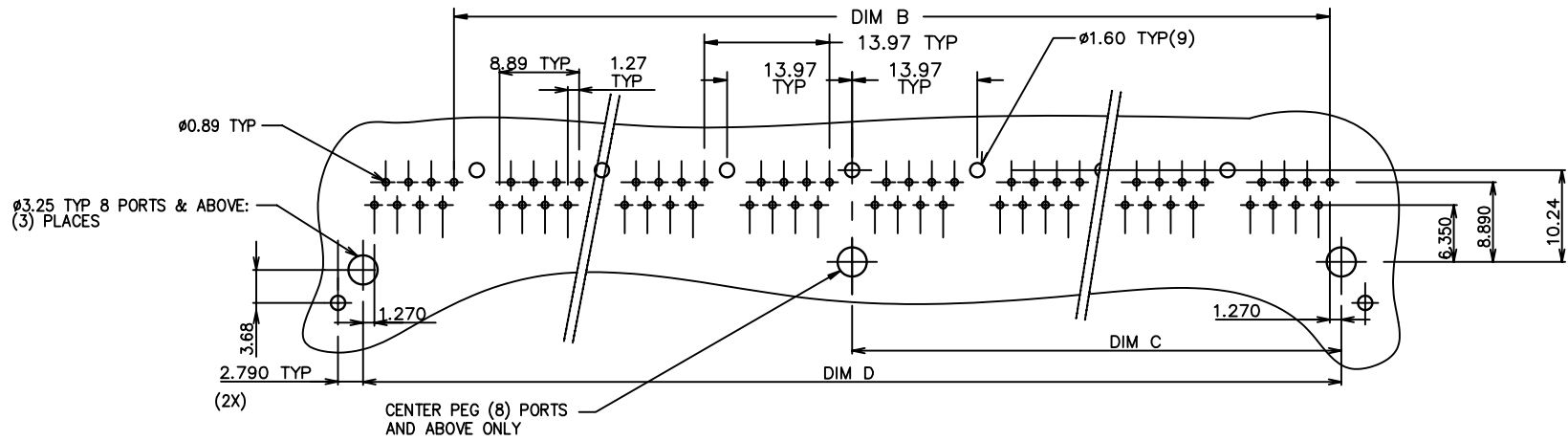

(SAME AS STANDARD CODE "Z"=0)

RECOMMENDED P.C.B LAYOUT

CODE "Z" = 2 (ALL GROUND LEGS)

mat'l. code				tolerances unless otherwise specified			CUSTOMER COPY		 www.fciconnect.com	
ltr	ecn no	dr	date	linear	.X ±.3		projection	 title R/A CAT 5 GANG JACK ASSY 8 POS SHIELDED DIAMOND PEG		
M	N04-0043	ZC	10/8/04		.XX ±.10					
					.XXX ±.050					
				angles	0° ±2°		 MM	product family		code
				dr	L.POTTEIGER	1/30/03		MOD JACK		213
				enr	J.KONTOS	1/30/03		size		sheet
				chr	J.KONTOS	1/30/03	scale	A4		6 of 7
				appd	J.KONTOS	1/30/03		95676		
sheet index	revision sheet						1:1			

Tous droits strictement reserves. Reproduction ou communication a des tiers interdite sous quelque forme que ce soit sans autorisation écrite du propriétaire. Propriete de c FCI. Droits de reproduction FCI.



All rights strictly reserved. Reproduction or issue to third parties in any form whatever is not permitted without written authority from the proprietor. Property of FCI. Copyright FCI.

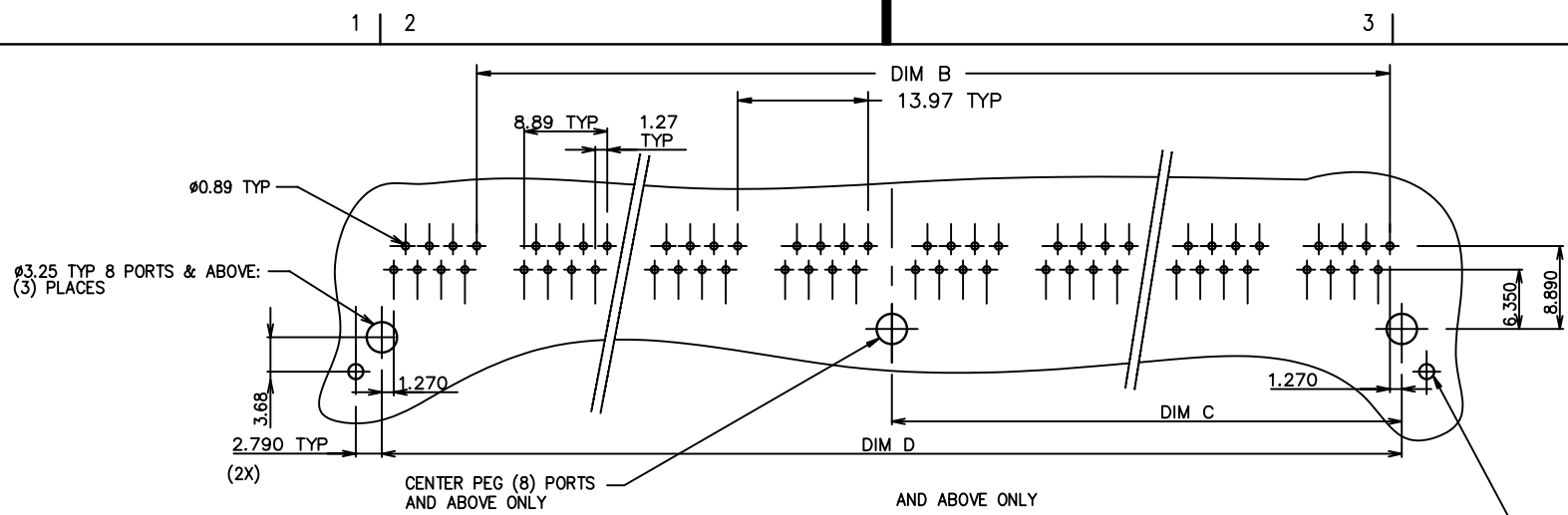

CENTER PEG (8) PORTS AND ABOVE ONLY

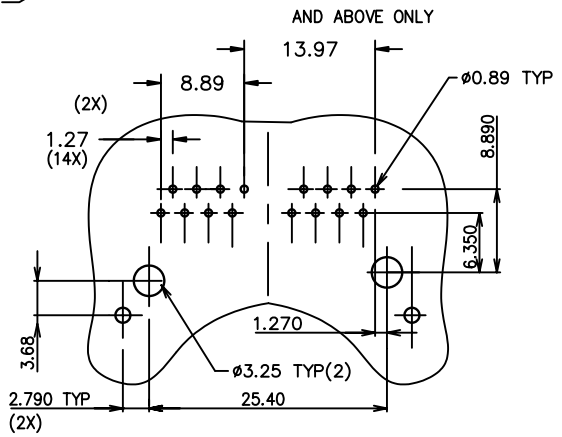

2-PORT

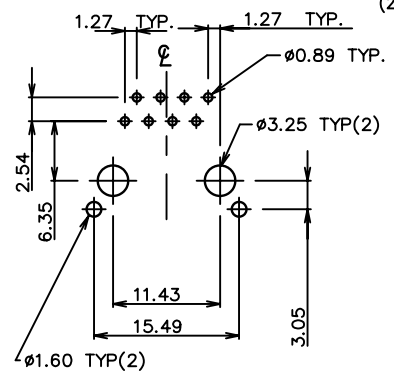

FOR 1-PORT, -X01
SAME AS STD CODE "Z"=0

RECOMMENDED P.C.B LAYOUT

CODE "Z" = 3 (NO GROUND LEGS)

mat'l. code				tolerances unless otherwise specified			CUSTOMER COPY		 www.fciconnect.com	
ltr	ecn no	dr	date	linear	.X ±.3		projection	 MM		
M	N04-0043	ZC	10/8/04		.XX ±.10					
					.XXX ±.050					
				angles	0° ±2°					
				dr	L.POTTEIGER	1/30/03	scale		A4	
				enr	J.KONTOS	1/30/03				
				chr	J.KONTOS	1/30/03				
				appd	J.KONTOS	1/30/03				
sheet index		revision sheet								

title
R/A CAT 5 GANG JACK ASSY
8 POS SHIELDED DIAMOND PEG

product family MOD JACK code 213
size dwg no 95676 sheet 7 of 7