

HAKKO

Quality Tools For The Electronics Industry

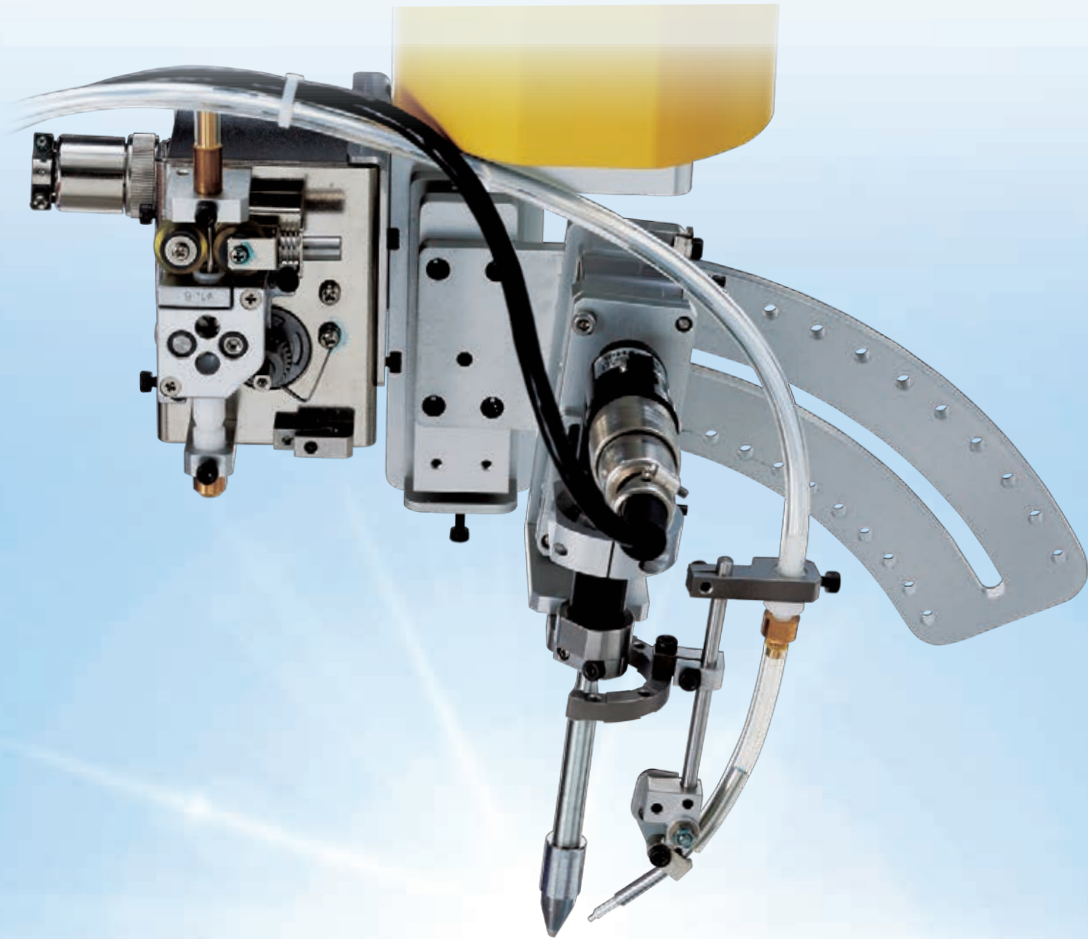

Challenge Toward Innovation



HAKKO Gio



HAKKO brand is much loved in more than 50 countries worldwide.

HAKKO has grown into a global brand. Our soldering irons and related equipment are hard at work in more than 50 countries. We have local branches and sales representatives around the world, and continue to expand our global network.



<http://www.hakko.com>

 **HAKKO** is registered in countries and regions including the following.
Japan, USA, South Korea, Singapore, China, the member of CTM.

Global Network



As of Mar. 2019

《《《 WORLDWIDE NETWORK 》》》



For more details on HAKKO affiliates and distributors, visit the official HAKKO website at www.hakko.com



HAKKO products pioneer

1



2



the next generation

3



4



Challenge Toward Innovation

A Smart Way to build an
Auto-Soldering System

Auto-Soldering System

FU-500 ESD SAFE >> P.14

FU-601 ESD SAFE >> P.14

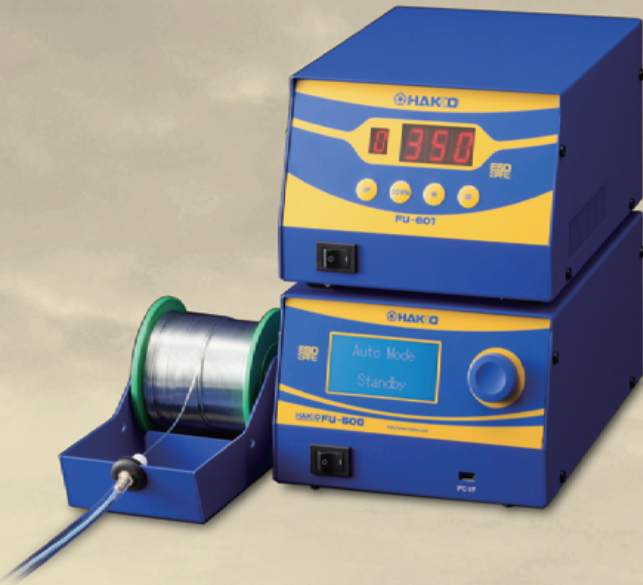

AUTO-SOLDERING

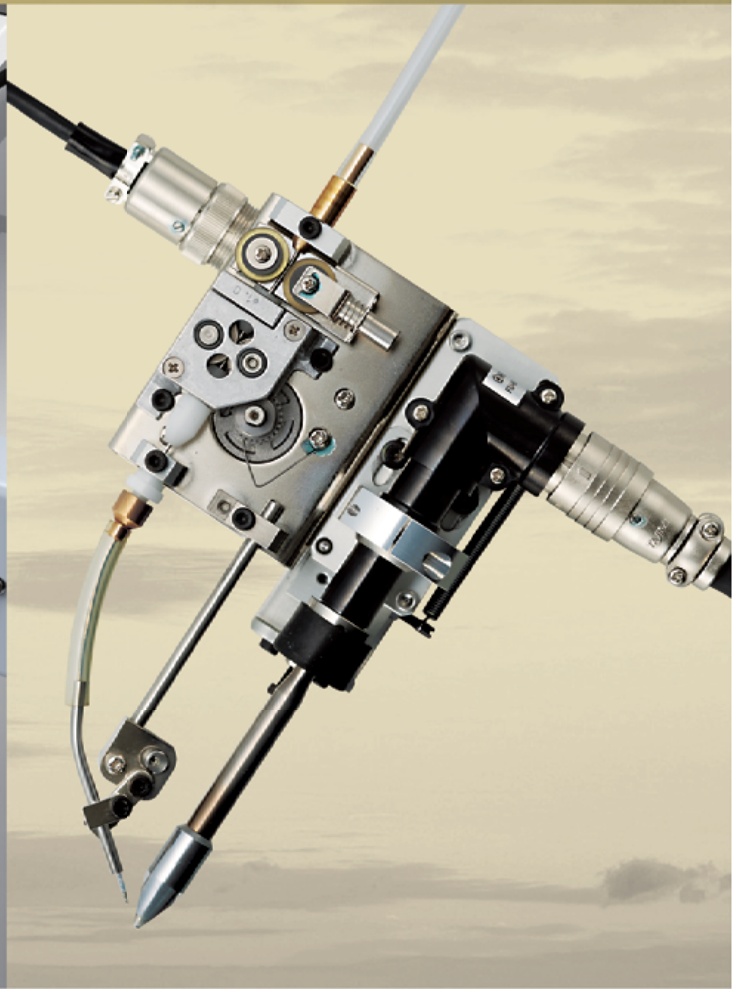
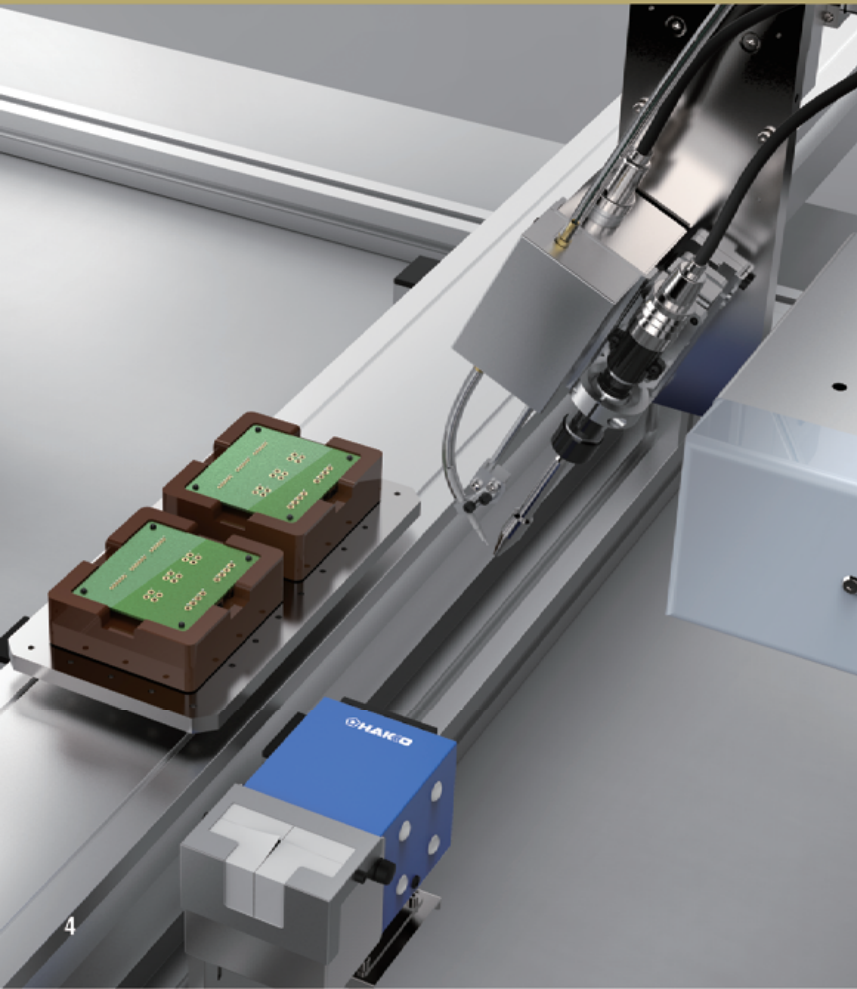

Best suited for soldering P.W.B. with high heat capacity and high heat dissipation property
Make the impossible possible with Super Power of 300 W Heater

Heavy Duty Soldering Station

FX-801 ESD SAFE » P.22



POWER SOLDERING™

300 W heavy duty desoldering tool with built-in vacuum pump
Secure desoldering with valve function

Heavy Duty Desoldering Tool

FR-400 ESD SAFE » P.78



Ideal for Micro Soldering applications
under a microscope

Micro Soldering Iron

FX-1002 ESD SAFE » P.35



MICRO SOLDERING

Ideal for Micro Soldering applications
under a microscope

Micro Soldering Iron

FM-2032 ESD SAFE



FX-951 ㊦
» P.30

FM-203 ㊦
» P.38

FM-206 ㊦
» P.38

Thermal wire stripper that ensures clean-cut removal of wire insulation

Thermal Wire Stripper

FT-802 ESD SAFE » P.64

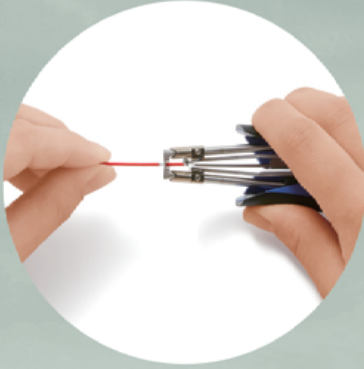

WIRE HARNESS ASSEMBLY

Stepless control on temperature and airflow for optimal settings

Heating Gun

FV-310 » P.110



Quality Tools for the



HAKKO is certified under ISO 9001 (JIS Q 9001), the international standard for quality management systems. We are also certified under ISO 14001 (JIS Q 14001) and are actively involved in preserving the global environment.

See the official HAKKO website for all necessary information regarding HAKKO products and services.

• HAKKO WEBSITE



• SELECT TIP SHAPE

Search for the appropriate tip for your work by following the guidelines.

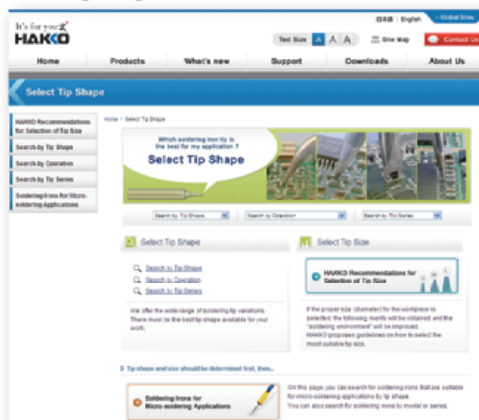

http://www.hakko.com/english/tip_selection/

• DOCUMENT PORTAL

Download instruction manuals, SDSs, and technical documents from the HAKKO Document Portal.



<https://doc.hakko.com/?l=en>

Electronics Industry



FN-1010 ESD SAFE

IoT Capable Soldering Station

Page
18



FG-100B

Thermometer with
Auto-measurement Function

Page
108



FR-301

Portable Desoldering Tool

Page
76



HAND TOOLS

Cutting pliers, pliers and tweezers

Page
66



FT-802 ESD SAFE

Thermal Wire Stripper

Page
64



FG-470

Wrist Strap Tester

Page
103



Index

Auto-Soldering System

Auto-Soldering System

FU-500 Solder Feed Unit	FU-601 Soldering Iron Unit	FU-6001 Soldering Iron	FU-6002 Soldering Iron
			
P.14	P.14	P.14	P.14

Soldering Iron

IoT Capable Soldering Station		Heavy Duty Soldering Station		IH Soldering Station & Accessory		High Performance Soldering Station & Accessories		
FN-1010 100 W	FX-801 300 W	FX-838 150 W	FX-100 IH	FX-1002 Micro Soldering Iron	FX-951 70 W	FX-950 70 W	FM-2032 Micro Soldering Iron (48 W)	
								
P.18	P.22	P.36	P.34	P.35	P.30	P.30	P.31	

High Performance Rework Station & Accessories

FM-203 2-Port Type	FM-206 3-Port Type	FM-207 Soldering Iron (70 W)	FM-2032 Micro Soldering Iron (48 W)	FM-2022 SMD Hot Tweezers (140 W)	FM-2023 Min SMD Hot Tweezers (140 W)	FM-2024 Desoldering Tool (70 W)	FM-2029 Hot Air Pencil (140 W)
							
P.38	P.38	P.39	P.39	P.39	P.39	P.39	P.39

All-Round Soldering Station & Accessories

FM-2030 Heavy Duty Soldering Iron (140 W)	FX-888D 65 W	FX-889 2-Port Type	FX-8801 Soldering Iron M type (65 W)	FX-8803 Soldering Gun (65 W)	FX-8804 SMD Hot Tweezers (65 W)	FX-8805 Soldering Iron L type (65 W)	FX-780 N ₂ Generator
							
P.39	P.24	P.24	P.27	P.27	P.27	P.27	P.46

FX-781 N ₂ Generator	FX-791 N ₂ Flowmeter	FN-1102 N ₂ Soldering Iron (95 W)	FX-8003 N ₂ Soldering Iron (260 W)	FX-8302 N ₂ Soldering Iron (150 W)	FM-2031 N ₂ Soldering Iron (140 W)	FM-2032 N ₂ Micro Soldering Iron (48 W)	FM-2026 N ₂ Soldering Iron (70 W)
							
P.46	P.46	P.47	P.47	P.47	P.47	P.47	P.47

Ceramic Heater Type				Battery-Powered Type		Nichrome Heater Type	
FX-8802 N ₂ Soldering Iron (65 W)	FX-600 For Electronics Parts Soldering	FX-601 For Heavy Duty Soldering	DASH	PRESTO	FX-901	RED	MG Solder Feed Soldering iron
							
P.47	P.52	P.52	P.54	P.55	P.56	P.57	P.57

Soldering Pot

Soldering Pot			Flow Soldering System
FX-301B High Performance Type	FX-300 High Performance Type	96	485
			
P.58	P.58	P.60	P.60

Soldering-Related Equipment & Materials

Tools for Lead and Wire

FT-802
Thermal Wire Stripper

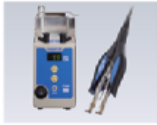

P.64

153 / 154
Lead Cutter And Former

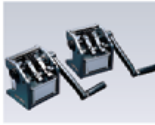

P.68

155
Lead Cutter



P.68

152B
Motor Drive



P.69

DIPLINER
Lead Straightener

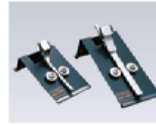

P.69

HAND TOOLS



P.66

106
Cutting Tool



P.67

Self Feeder

373
Self Feeder



P.62

375
V-Groove Maker



P.61

Tip Cleaner

FT-710



P.70

Tip Polisher

FT-700 & FS-100



P.71

Iron Holder & Reel Stand

Iron holder



P.72

611

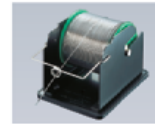

P.72

Vacuum Pick-Up Tool

392
Outlet-Powered Type



P.74

393
Dropper Type



P.74

394
Battery-Powered Type



P.74

Flux Pen

FS-210



P.73

Desoldering & Rework

Heavy Duty Type

FR-400
300 W



P.78

High-Power Type

FR-410
140 W



P.78

Desoldering Tool & Wire

FM-204
70 W



P.81

FR-301
Portable Type



P.76

SPPON



P.82

WICK

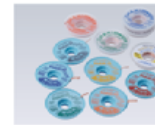

P.82

Repair System

FR-701
2-Port Type



P.92

Rework System

FR-702
4-Port Type



P.93

Preheater

FR-870B
IR Type (M-Size)



P.94

FR-872
IR Type (L-Size)

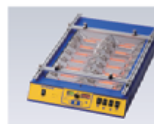

P.94

FR-830
Hot Air Type



P.94

SMD Rework Station

FR-810B



P.84

FR-811



P.84

851



P.83

Smoke Absorber

Air-Purifying Type

FA-430
HEPA Filter



P.96

FA-431
Cost Performance Filter



P.97

Desktop Type

FA-400

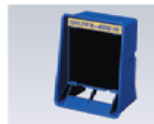

P.99

490



P.100

Line Production System

494



P.101

Static Control

Static Eliminator

FE-510



P.102

Wrist Strap

442B



P.103

Tester & Meter

Wrist Strap Tester

FG-470



P.103

Footwear Tester

FG-460

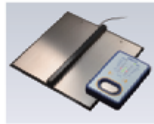

P.104

Thermometer

FG-102

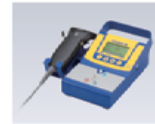

P.106

FG-100B



P.108

Soldering Tester

FG-101



P.108

Static Level Meter

FG-450



P.105

Heating Gun & Glue Gun

Heating Gun

FV-310



P.110

Glue Gun









804



P.112

HAKKO Soldering Iron Lineup

		FN-1010	FX-801	FX-838	FX-100	FX-951	FX-950	FM-203	FM-206	
Types		IoT Capable	Heavy Duty		IH	High Performance				
Specifications	Power consumption	100 W	300 W	158 W	25 W (85 W)	75 W	75 W	140 W	410 W (max.)	
	Power consumption of Handpiece	95 W	260 W	150 W	—	70 W	70 W	70 W × 2 port	70 W × 3 port	
	Temperature Range	50 to 450°C	50 to 500°C	200 to 500°C	350°C/400°C/450°C	200 to 450°C	200 to 450°C	200 to 500°C	200 to 500°C	
	Soldering Tip	T36 series	T33 series (Regular / Slim)	T20 series	T31 series	T12 series	T12 series	T12 series	T12 series	
Applicable Standard	Lead Free Suggestible	●	●	●	●	●	●	●	●	
	ESD Safe	●	●	●	●	●	●	●	●	
	RoHS Suggestible	●	●	●	●	●	●	●	●	
Accessories	Micro Soldering Iron connectable				●	●		●	●	
	N ₂ Micro Soldering Iron connectable					●		●	●	
	N ₂ Soldering Iron connectable	●		●		●	●	●	●	
	N ₂ Heavy Duty Soldering Iron connectable		●	●					●	
	Self Feeder connectable	●	●	●	●	●	●	●	●	
	SMD Hot Tweezers connectable							●	●	
	Desoldering Iron connectable							●	●	
	Hot Air Handpiece connectable								●	
Function	Auto Shutoff Function: When a set time passed, the function stops to supply power to the heating element.									
		●	●	●	●	●	●	●	●	●
	Auto Sleep Function: When a set time passed, the tip temperature decreases to a set lower temperature.									
		●	●	●	●	●	●	Option	●	●
	Lock Function: Lockable by password, control card or lock key.									
		Password	Password	Control card	Password	Control card	Lock key	Control card	Password	
	Lower Temperature Error Alert: When the temperature drops below a set limit, an error is displayed and the buzzer sounds.									
		●	●	●		●		●		
Offset Temperature Function: Temperature offsettable by analog, digital or adjustment mode.										
	Digital	Digital	Digital			Digital	Manual	Digital	Digital	
Preset Temperature Function: The function allows to input several frequently-used temperatures and recall with one push of a button.										
	●	●	●						●	

FX-888D	FX-889	FX-600	FX-601	DASH	PRESTO	FX-901	RED	MG
								
All-Round		Ceramic Heater			Battery-Powered		Nichrome Heater	
70 W	135 W	50 W	47 W	15 to 16 W	20 W/130 W	6 W/5 W	20 W/30 W 40 W/60 W	30 W/40 W 60 W/80 W 100 W/150 W
65 W	65 W x 2 port	—	—	—	—	—	—	—
50 to 480°C	50 to 480°C	200 to 500°C	240 to 540°C	—	—	—	—	—
T18 series	T18 series	T18 series	T19 series	T34 series	980-T series	T11 series	BB series	582-T-4 585-T-6 587-T-8 592-T-10
●	●	●	●					
●	●							
●	●	●	●	●	●	●	●	●
●	●							
●	●							
Password	Password	Lock key	Lock key					
Adjustment mode	Adjustment mode	Manual	Manual					
●	●							

FU-500 ESD SAFE FU-601 ESD SAFE

Auto-Soldering System

Tip not included



FU-500 ESD

- Accurate solder feeding
- Supports solder diameters of 0.3 mm and up to 1.6 mm
- Solder feed error detection
- Equipped with countermeasures against solder ball splash as standard

FU-601 ESD

- Easy tip replacement
- High performance composite tip
- Six presets tip-temperature function
- 300 W of ultra-high power

Packing List

FU-500	Main unit, Feeder unit, Solder reel stand, Feeder cable, Tube units, Power cord, Instruction manual
FU-601	Station, Handpiece (FU-6001 or FU-6002), Iron unit fixing assembly, Tip adjustment jig units, Iron cable, Heat resistant pad, Connecting cable, Power cord, Flux protector, Feeder unit attachment screw, Instruction manual

Specifications

Model No.	FU-500
Power consumption	35 W
Compatible solder diameters	0.3 mm, 0.5 mm, 0.6(0.65) mm, 0.8 mm, 1 mm, 1.2 mm, 1.6 mm
Dimensions	145 mm (W) × 100 mm (H) × 230 mm (D)
Weight	2.3 kg

Model No.	FU-601
Power consumption	140 W/300 W
Temperature range	50 to 500°C
Preset temperature	6 settings
Dimensions	145 mm (W) × 107 mm (H) × 211 mm (D)
Weight	4 kg

Soldering Iron

Model No.	FU-6001	FU-6002
Total length	186 mm with 2.4XD tip for TX1 194 mm with 4XD tip for TX2	160 mm with 2.4XD tip for TX1 168 mm with 4XD tip for TX2
Weight*	163 g with 2.4XD tip for TX1 171 g with 4XD tip for TX2	165 g with 2.4XD tip for TX1 173 g with 4XD tip for TX2

* With iron unit fixing assembly

Optional Parts

* The accessories are required for initial set-up, such as a solder feed pulley unit, solder-feed guide set and teflon tube are not included. They must be ordered separately and adapted to use with the soldering iron and solder wire diameter.

Part No.	Name	Remarks
BX1000	Solder feed pulley unit/0.3 mm	
BX1001	Solder feed pulley unit/0.5 mm	
BX1002	Solder feed pulley unit/0.6 mm	
BX1003	Solder feed pulley unit/0.8 mm	
BX1004	Solder feed pulley unit/1 mm	
BX1005	Solder feed pulley unit/1.2 mm	
BX1006	Solder feed pulley unit/1.6 mm	
BX1007	Solder feed guide set/0.3 mm	
BX1008	Solder feed guide set/0.5 to 1 mm	
BX1009	Solder feed guide set/1.2 to 1.6 mm	
BX1010	Teflon tube/0.3 mm (set of 10)	
BX1011	Teflon tube/0.5 to 0.6 mm (set of 10)	
BX1012	Teflon tube/0.8 mm (set of 10)	
BX1013	Teflon tube/1 mm (set of 10)	
BX1014	Teflon tube/1.2 mm (set of 10)	
BX1015	Teflon tube/1.6 mm (set of 10)	
BX1023	Adapter assembly for TX1	
BX1029	Adapter assembly A for TX2	
BX1024	Nozzle assembly <A> for TX1	
BX1025	Nozzle assembly for TX1	
BX1026	Nozzle assembly <C> for TX1	
BX1030	Nozzle assembly <D> for TX2	
BX1031	Nozzle assembly <E> for TX2	
CX1000	Slide unit	
CX1001	Slide unit for drag soldering	
CX1002	Temperature probe	
CX1003	Cleaner	

Features

300 W of ultra-high power FU-601 is added to Auto-Soldering System.

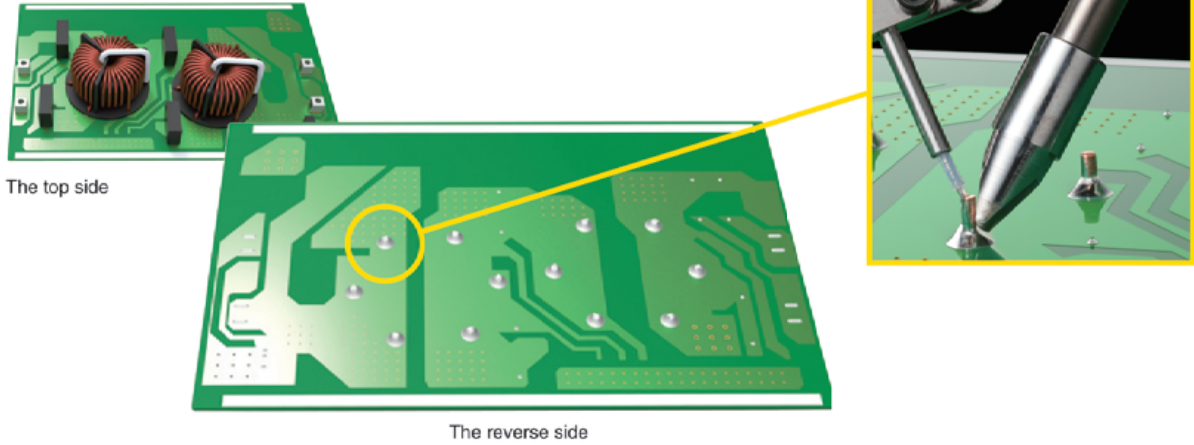

The top side

The reverse side

TX1/TX2 series can provide excellent thermal recovery characteristic despite its compact design.

140 W TX1 Series



300 W TX2 Series



Accurate solder feeding

The solder feed unit is closer to the iron.

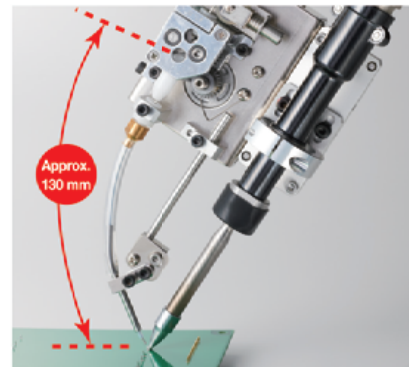

Countermeasures against solder ball splash

Equipped with a mechanism that perforates into the solder wire as standard.

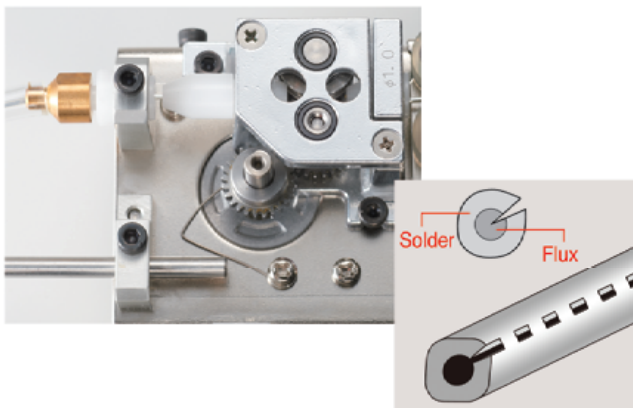

Easy tip replacement

The position of the tip end can be easily adjusted using the tip adjustment jig unit included with FU-601.

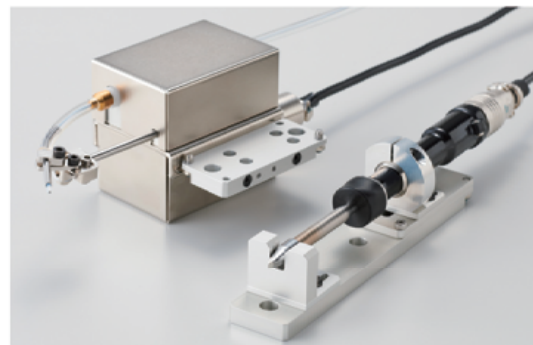

Auto-Soldering System

More Features

Solder feed error detection

With an optical sensor for solder movement, FU-500 can detect solder clogging, slipping and the end of the roll.

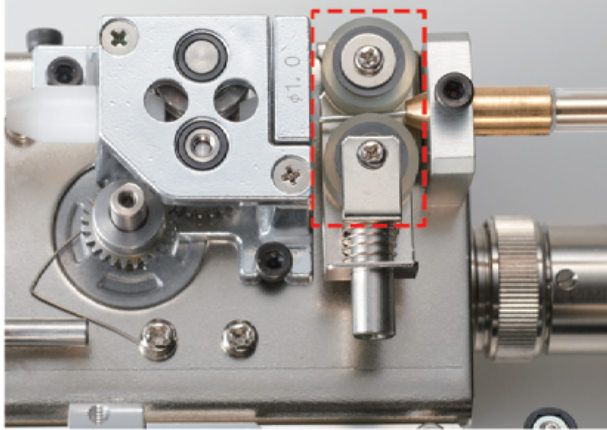

Two types of soldering irons

Straight iron FU-6001

L-shaped iron FU-6002



Optional Parts & Accessories

Slide unit

This unit allows the soldering unit vertical movement with external air.

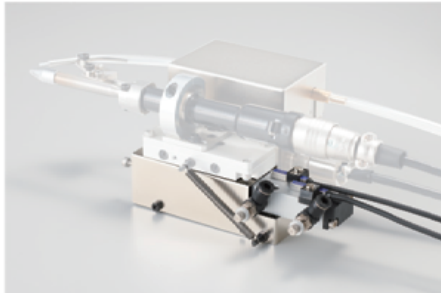

Slide unit (for drag soldering)

This unit absorbs height variation.

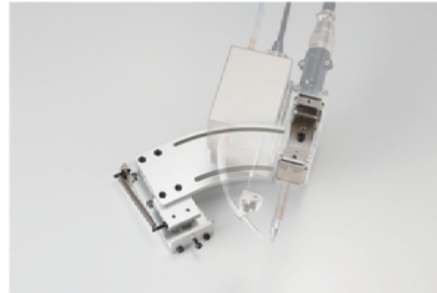

Tip cleaner

The brush removes excess solder and flux carbides.



Temperature probe

The probe makes tip temperature measurement easy.



N₂ adapter assembly

Simply attach the optional N₂ adapter to the iron and install a nozzle assembly that matches the tip to perform N₂ soldering.

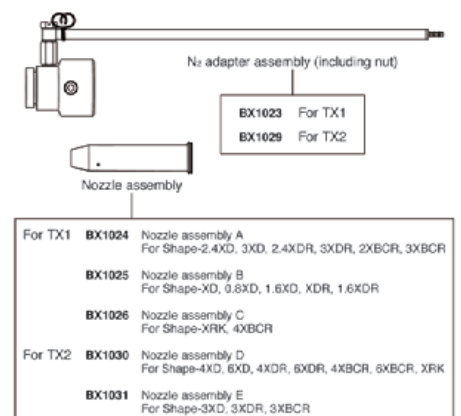

Optional Tips for 140 W

Unit: mm

<p>TX1-XD Shape-XD</p>	<p>TX1-XD08 Shape-0.8XD</p>	<p>TX1-XD16 Shape-1.6XD</p>	<p>TX1-XD24 Shape-2.4XD</p>	<p>TX1-XD3 Shape-3XD</p>
<p>TX1-XBCR2 Shape-2XBCR</p>	<p>TX1-XBCR3 Shape-3XBCR</p>	<p>TX1-XBCR4 Shape-4XBCR</p>	<p>TX1-XDR Shape-XDR</p>	
<p>TX1-XDR16 Shape-1.6XDR</p>	<p>TX1-XDR24 Shape-2.4XDR</p>	<p>TX1-XDR3 Shape-3XDR</p>	<p>TX1-XRK Shape-XRK</p>	

Optional Tips for 300 W

Unit: mm

<p>TX2-XD3 Shape-3XD</p>	<p>TX2-XD4 Shape-4XD</p>	<p>TX2-XD6 Shape-6XD</p>	<p>TX2-XBCR3 Shape-3XBCR</p>
<p>TX2-XBCR4 Shape-4XBCR</p>	<p>TX2-XBCR6 Shape-6XBCR</p>	<p>TX2-XDR3 Shape-3XDR</p>	<p>TX2-XDR4 Shape-4XDR</p>
<p>TX2-XDR6 Shape-6XDR</p>	<p>TX2-XRK Shape-XRK</p>		

FN-1010 ESD SAFE New

IoT Capable Soldering Station Digital

Tip not included



- Enables human error-free temperature control and traceability of manual soldering process

Optional Tips for FN-1101

Unit: mm

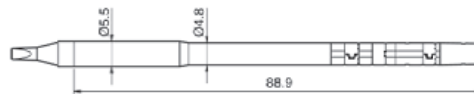

T36-B Shape-0.2B 	T36-B2 Shape-0.5B 	T36-BL Shape-BL 	T36-BC1 Shape-1BC 	T36-BC2 Shape-2BC 	T36-BC3 Shape-3BC
T36-C1 Shape-1C 	T36-C4 Shape-4C 	T36-D08 Shape-0.8D 	T36-D16 Shape-1.6D 	T36-D24 Shape-2.4D 	T36-DL32 Shape-3.2DL
T36-D52 Shape-5.2D 	T36-I Shape-I 	T36-ILS Shape-ILS 	T36-J02 Shape-0.2J 	T36-JS02 Shape-0.2JS 	T36-K Shape-K

Features

“Process control” and “Traceability” can be established through daily manual soldering operation.



Information to be collected by T36 series tip

The following information can be collected by memory chip in T36 series tip and saved in a computer through a soldering station.

- Tip shape
- Serial number
- Number of loads
- Total time of power supplied
- Load Sensitivity
- Type of solder alloy (Lead-Free / Lead)
- Count alarm



Optimization of soldering conditions is now possible based on a variety of information in daily soldering process collected by FN-1010.

Connectable with N₂ soldering iron

To improve solder wettability and spreadability

FN-1102 氮

N₂ Soldering Iron

Tip not included

Please see the optional tips on P.48.



For further details, see the N₂ system (P.46 & P.47).

Packing List

FN-1010	Station, Handpiece (FN-1101), Tip cleaner (FT-401, with cleaning wire), Power cord, Iron holder, Instruction manual
FN-1102	Handpiece, Instruction manual

Specifications

Model No.	FN-1010
Power consumption	100 W
Temperature range	50 to 450°C
Temperature stability	±3°C at idle temperature

Station

Output voltage	AC 21 V
Dimensions	104 (W) × 138 (H) × 152 (D) mm
Weight	1.9 kg

Soldering Iron

Power consumption	95 W (21 V)
Tip to ground resistance	<2 Ω
Tip to ground potential	<2 mV
Heating element	Composite heater
Cord length	1.2 m
Total length*	180 mm (with 2.4D tip)
Weight*	32 g (with 2.4D tip)

* Without cord

Model No.	FN-1102
Power consumption	95 W (21 V)
Tip to ground resistance	<2 Ω
Tip to ground potential	<2 mV
Heating element	Composite heater
Cord length	1.2 m
Total length*	180 mm (with 2.4D tip)
Weight*	50 g (with 2.4D tip and nozzle assembly A)

* Without cord and tube

IoT Capable Soldering Station

More Features

Automatic calibration/off-set can be completed once measurement result is sent through infrared.



Human error-free “tip temperature calibration” and “off-set” can be established through daily manual soldering process. Results of measurement/calibration/off-set can be recorded automatically.

Eliminate human error in manual recording of measurement result by using FG-100B

Human errors in manual recording process and time for recording can be eliminated by sending measurement result from FG-100B to FN-1010.



For further information of FG-100B, see P. 108.

Visualize energy supplied during soldering

It is now possible to visualize invisible energy supplied from T36 series tip during soldering. And that makes it possible to control factors of soldering, which were impossible before.



Start Time	Time	Sensor Temp	Load Energy
	141.05	350	0
	141.225	349	2
	141.4	346	5
	141.575	344	9
	141.75	340	15
	141.925	340	23
	142.1	339	33
	142.275	337	42
	142.45	334	47
	142.625	331	48
	142.8	330	47
	142.975	329	53
	143.15	344	55
	143.325	343	54
	143.5	343	0

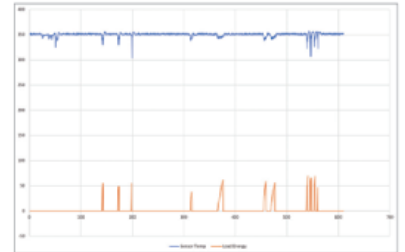

Real-time work status on the LCD screen

Set temperature Tip shape

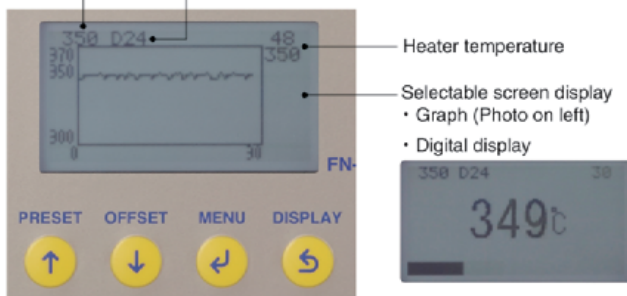

Improved button operation

Quick access to “Preset temperatures” and “Off-set mode” with one push.

It takes few button operation to access to most frequently used functions.

Notification of alarm with sound and vibration

Alarm can be notified with vibration in a noisy environment.

Free fall detection function

Built-in motion sensor detects free fall and cuts the power. It can prevent burning floor, a fire and other accident with the heat.



Tip cleaner with solder ball preventive design

Solder ball during tip cleaning can be reduced by 99% with devised cleaner designs such as smaller aperture, and set angle as well as position.

* In-house comparison







Tip replacement without heat resistant pad



Option for IoT communication

Please choose the options according to the numbers of units and the connection port of PC and server.

Type	Specifications and Part No.	Connectable numbers	Compatibility with PC	Sequence control	Example of connection
Interface Card for FN-1010	 USB type with cable No. B5210	One unit per one PC	○	×	
	 RS232C type with cable No. B5211	One unit per one PC	△*	○	
	 LAN type No. B5212	Multiple units per one PC	○	×	

* RS232C cannot be connected with some PCs. Please check.

Heavy Duty Soldering Station

FX-801 ESD SAFE

Heavy Duty Soldering Station Digital

Tip not included



- Super power 300 W
- Best suited for soldering P.W.B. with high heat capacity and high heat dissipation property

Optional Tips for FX-8002

Unit: mm

Regular type

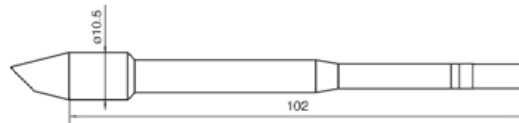

T33-BC2 Shape-2BC 	T33-BC3 Shape-3BC 	T33-BC4 Shape-4BC 	T33-BC5 Shape-5BC 	T33-BC6 Shape-6BC 	T33-D24 Shape-2.4D
T33-D32 Shape-3.2D 	T33-D5 Shape-5D 	T33-D6 Shape-6D 	T33-1610 	T33-1611 	

Slim type

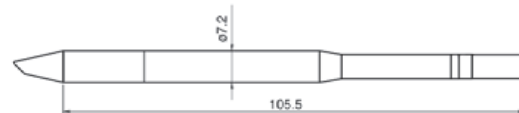

T33-SSBC2 Shape-2SSBC 	T33-SSBC3 Shape-3SSBC 	T33-SSBC4 Shape-4SSBC 	T33-SSBC5 Shape-5SSBC 	T33-SSD16 Shape-1.6SSD 	T33-SSD24 Shape-2.4SSD
T33-SSD32 Shape-3.2SSD 	T33-SSD6 Shape-6SSD 	T33-SS1610 	T33-SS1611 		

Features

Make the impossible possible with Super Power of 300 W Heater



Check out the powerful performance of FX-801 easily melting a bar solder.

http://www.hakko.com/mov_e_fx801_feature1



QR code

Compact and lightweight (50 g) for heavy duty 300 W iron
The same weight as the iron part of FX-838, 150 W soldering station, for operator's comfort and better workability.

A wide variety of tip shapes

• Regular type

Best suited for components with high thermal mass such as transformers and coils.

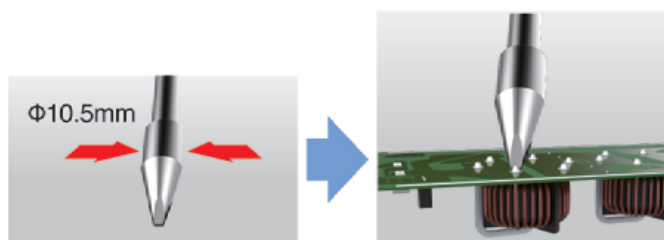

• Slim type

Slimmed-down tips for narrow spaces without losing of enough power.

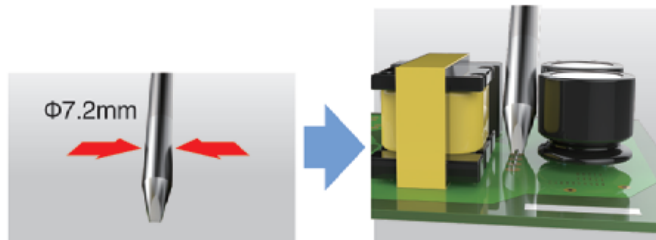

Connectable with N₂ soldering iron

To improve solder wettability and spreadability

FX-8003 錫

N₂ Soldering Iron

Tip not included

Please see the optional tips on P.49.



For further details, see the N₂ system (P.46 & P.47).

Packing List

FX-801	Station, Handpiece (FX-8002), Heat resistant pad, Power cord, Connecting cable, Iron holder (with cleaning wire), Instruction manual
FX-8003	Handpiece, Instruction manual

Specifications

Model No.	FX-801
Power consumption	300 W
Temperature range	50 to 500°C
Temperature stability	±5°C at idle temperature

Station

Output voltage	AC 29 V
Dimensions	145 (W) × 107 (H) × 211 (D) mm
Weight	3.9 kg

Soldering Iron

Power consumption	260 W (29 V)
Tip to ground resistance	<2 Ω
Tip to ground potential	<2 mV
Heating element	Composite heater
Cord length	1.2 m
Total length*	228 mm (with 4BC tip)
Weight*	50 g (with 4BC tip)

* Without cord

Model No.	FX-8003
Power consumption	260 W (29 V)
Temperature range	50 to 500°C
Tip to ground resistance	<2 Ω
Tip to ground potential	<2 mV
Heating element	Composite heater
Cord length	1.2 m
Total length*	253 mm (with 4BC tip)
Weight*	65 g (with 4BC tip and nozzle assembly A)

* Without cord

FX-888D ESD SAFE

All-Round Soldering Station **Digital**

Tip included



- Features Adjustment mode, Preset mode, and Password function
- Separable tip/heater design provides superior cost performance.
- L type (large type) soldering iron FX-8805 is added to the lineup.

FX-889 ESD SAFE

2-Port All-Round Soldering Station **Digital**

Tip included

* 1 piece of FX-8801 is included as standard.



- All the user-friendly functions are succeeded from FX-888D.
- Two applications can be active at the same time.
- Applicable to all the options, N₂ soldering iron, Soldering gun, SMD Hot Tweezers, and L type (large type) soldering iron.

Common features

Strict temperature management

● Digital display

FX-888D's and FX-889's digital display makes it easy to check the set temperature at a glance.

● Password function

Settings can be locked using a password to prevent them from being changed unexpectedly.

● Preset mode

Simply select the desired temperature from a selection of preset temperatures registered in advance. (up to 5 preset temperatures can be registered.)



● Adjustment mode

With adjustment mode, what used to be a troublesome procedure is now as simple as entering the measured tip temperature in FX-888D and FX-889.

● FX-888D and FX-889 deliver excellent thermal recovery by using T18 and T19 series tips for their terrific heat conductivity.

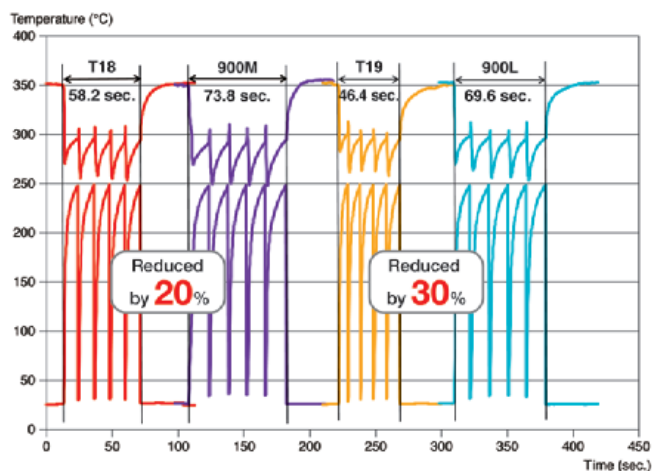

Test criteria

Measurement method	Thermocouples are mounted on the tip and the soldered portion on the board, and the time until the soldered portion reaches 250°C is measured for 5 points.
Board	Paper phenol copper board
Component used	Terminal
Tip shape	Shape-2.4D
Temperature setting	350°C
Solder	Lead-free solder (Sn/Ag/Cu), diameter: 0.5 mm



Measuring the tip temperature with a tip thermometer (FG-100B)

Packing List

FX-888D	Station, Handpiece (FX-8801), Iron holder, Instruction manual
FX-889	Station, Handpiece (FX-8801), Power cord, Dual Iron Holder, Color band (qty 2), Instruction Manual

Specifications

Model No.	FX-888D	FX-889
Power consumption	70 W	135 W
Temperature range	50 to 480°C	50 to 480°C
Temperature stability	±1°C at idle temperature (when set to 200 to 480°C)	

Station

Output voltage	AC 26 V	AC 26 V
Dimensions	100 (W) × 120 (H) × 120 (D) mm	157 (W) × 121 (H) × 149 (D) mm
Weight	1.2 kg*	2.1 kg

Soldering Iron

Power consumption	65 W (26 V)	65 W (26 V)
Tip to ground resistance	<2 Ω	<2 Ω
Tip to ground potential	<2 mV	<2 mV
Heating element	Ceramic heater	Ceramic heater
Standard tip	Shape-B (No. T18-B)	Shape-B (No. T18-B)
Cord length	1.2 m	1.2 m
Total length*	217 mm (with B tip)	217 mm (with B tip)
Weight*	46 g (with B tip)	46 g (with B tip)

* Without cord

All-Round Soldering Station and Accessories

Features of FX-889

User-Friendly Design

● Space-saving design

The reduced foot print is smaller than 2 of FX-888D and its iron holder. Efficient setup is available even on smaller workbench.

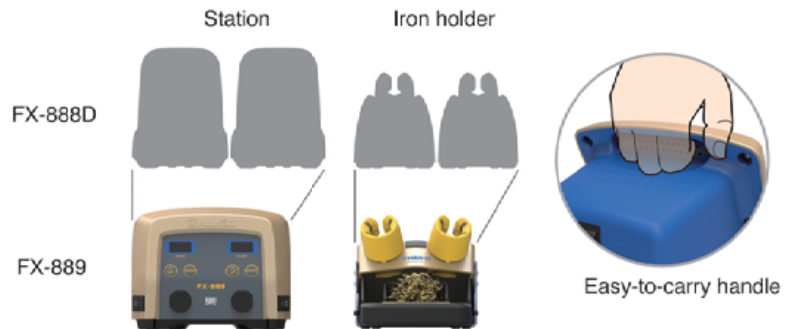

● Power-saving design

Independent switches cut the power for each iron when not in use. Power-saving design minimizes standby electricity.

● Superior operability

Four buttons were symmetrically placed at the both sides on the front panel. The two buttons on each side allow simple and intuitive operation.

A color band can be attached to the handle, and this makes it possible to see at a glance which side it is connected to. (2 pieces of color band are included as the standard accessories.)



● Rich functions of iron holder

- Convenient pockets to stock soldering tips
- Three different ways for tip cleaning with provided cleaning tools
- Simple and easy cleaning of iron holder inside by removing holder base

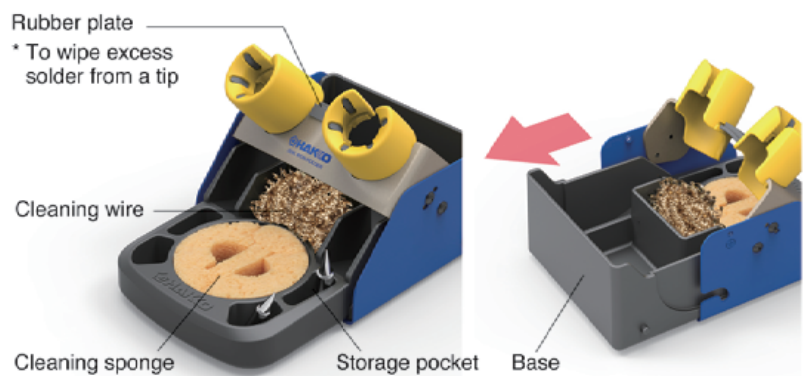

FX-8801 ESD SAFE**Soldering Iron M type**

Tip included

**FX-8802** ESD SAFE**N₂ Soldering Iron**

Tip included

**FX-8803** ESD SAFE**Soldering Gun**

Tip included

**FX-8804** ESD SAFE**SMD Hot Tweezers**

Tip included

**FX-8805** ESD SAFE**Soldering Iron L type**

Tip included

**Specifications**

Model No.	FX-8801
Power consumption	65 W (26 V)
Temperature range	50 to 480°C
Tip to ground resistance	<2 Ω
Tip to ground potential	<2 mV
Heating element	Ceramic heater
Standard tip	Shape-B (No.T18-B)
Cord length	1.2 m
Total length*	217 mm (with B tip)
Weight*	46 g (with B tip)

* Without cord

Model No.	FX-8802
Power consumption	65 W (26 V)
Temperature range	50 to 480°C
Tip to ground resistance	<2 Ω
Tip to ground potential	<2 mV
Heating element	Ceramic heater
Standard tip	Shape-B (No.T18-B)
Cord length	1.2 m
Total length**	190 mm (with B tip)
Weight**	59 g (with B tip and nozzle assembly A)

* Use this N₂ soldering iron below 450°C.

** Without cord and tube

Model No.	FX-8803
Power consumption	65 W (26 V)
Temperature range	50 to 480°C
Tip to ground resistance	<2 Ω
Tip to ground potential	<2 mV
Heating element	Ceramic heater
Standard tip	Shape-3C pre-linned surface 45° (No.T18-CF3)
Standard guide nozzle	ø1 mm
Usable solder diameter	0.6, 0.8, 1, 1.2, 1.6 mm
Cord length	1.1 m
Dimensions	170 (W) × 180 (H) × 23 (D) mm
Weight*	207 g

* Without cord

Model No.	FX-8804
Power consumption	65 W (26 V)
Temperature range	200 to 400°C
Tip to ground resistance	<2 Ω
Tip to ground potential	<2 mV
Heating element	Ceramic heater
Standard tip	Shape-2L (No. A1378) 2 pcs/set
Cord length	1.2 m
Total length**	186 mm
Weight**	93 g

* The recommended (process) temperature is from 200°C to 400°C while setting temperature range of FX-8804 is from 50°C to 480°C.

** Without cord

Model No.	FX-8805
Power consumption	65 W (26 V)
Temperature range	50 to 480°C
Tip to ground resistance	<2 Ω
Tip to ground potential	<2 mV
Heating element	Ceramic heater
Standard tip	Shape-B (No.T19-B)
Cord length	1.2 m
Total length*	222 mm (with B tip)
Weight*	52 g (with B tip)

* Without cord

All-Round Soldering Station and Accessories

Packing List

FX-8801	Handpiece, Instruction Manual
FX-8802	Handpiece, Shield plate, Instruction manual
FX-8803	Handpiece, Instruction manual
FX-8804	Handpiece, Caution label, Heat resistant pad, Instruction manual
FX-8805	Handpiece, Instruction Manual

NOTE: The soldering iron cannot be used as a standalone device.

Option

FX-8803

Part No.	Name	Specifications
C1437	Iron holder (with cleaning sponge)	-

FX-8804

Part No.	Name	Specifications
FH800-04BY	Iron holder (with cleaning sponge)	Blue & yellow

FX-8801 & FX-8805

Part No.	Name	Specifications
B5122	Tip enclosure	With nut, required when converting from FX-8801 to FX-8805
B3730	Nut and tip enclosure	Required when converting from FX-8805 to FX-8801

Replacement Tips for FX-8801 and FX-8803

Unit: mm

<p>Applicable for FX-8803</p> <p>T18-B Shape-B</p>	<p>Applicable for FX-8803</p> <p>T18-SB Shape-SB</p>	<p>T18-BR02 Shape-0.2BR</p>	<p>T18-BL Shape-BL</p>	<p>T18-C05 Shape-0.5C</p>
<p>Applicable for FX-8803</p> <p>T18-C08 Shape-0.8C</p>	<p>Applicable for FX-8803 (Only C1)</p> <p>T18-C1 Shape-1C T18-CF1*</p>	<p>T18-CF15* Shape-1.5C</p>	<p>Applicable for FX-8803</p> <p>T18-C2 Shape-2C T18-CF2*</p>	<p>Applicable for FX-8803</p> <p>T18-CSF25* Shape-2.5CS</p>
<p>Applicable for FX-8803</p> <p>T18-C3 Shape-3C T18-CF3*</p>	<p>Applicable for FX-8803</p> <p>T18-C4 Shape-4C T18-CF4*</p>	<p>Applicable for FX-8803</p> <p>T18-C5 Shape-5C</p>	<p>Applicable for FX-8803</p> <p>T18-K Shape-K</p>	<p>Applicable for FX-8803</p> <p>T18-D08 Shape-0.8D</p>
<p>Applicable for FX-8803</p> <p>T18-D12 Shape-1.2D</p>	<p>Applicable for FX-8803</p> <p>T18-D16 Shape-1.6D</p>	<p>Applicable for FX-8803</p> <p>T18-D24 Shape-2.4D</p>	<p>Applicable for FX-8803</p> <p>T18-D32 Shape-3.2D</p>	<p>T18-DL12 Shape-1.2DL</p>
<p>T18-DL2 Shape-2DL</p>	<p>T18-DL32 Shape-3.2DL</p>	<p>T18-S3 Shape-S3</p>	<p>Applicable for FX-8803</p> <p>T18-S4 Shape-S4</p>	<p>T18-S6 Shape-S6</p>
<p>Applicable for FX-8803</p> <p>T18-S9 Shape-S9</p>	<p>Applicable for FX-8803</p> <p>T18-I Shape-I</p>			



* These tips are tinned on the soldering surface only.

Replacement Tips and Nozzles for FX-8802

Please see the replacement tips on P.51.

Replacement Tips for FX-8804

For Chip Component

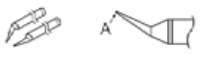
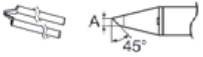





Part No.	Name	Size of A (B)	Tip Shape
A1577	Tip/CHIP 0.5L	0.5 mm	
A1379	Tip/CHIP 1L	1 mm	
A1378	Tip/CHIP 2L	2 mm	
A1388	Tip/CHIP 0.5C	1.5 (0.5) mm	
A1389	Tip/CHIP 0.5I	R0.25 mm	
A1576	Tip/CHIP 2.6C	2.6 mm	

For SOP Component

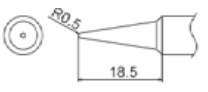
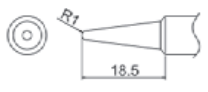
Part No.	Name	Size of A	Tip Shape
A1390	Tip/SOP 4L	4 mm	
A1391	Tip/SOP 6L	6 mm	
A1380	Tip/SOP 8L	8 mm	
A1381	Tip/SOP 10L	10 mm	
A1382	Tip/SOP 13L	13 mm	
A1392	Tip/SOP 15L	15 mm	
A1383	Tip/SOP 18L	18 mm	
A1384	Tip/SOP 20L	20 mm	
A1385	Tip/SOP 25L	25 mm	

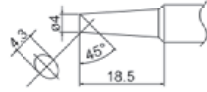
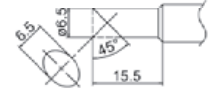
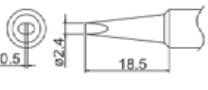
Replacement Tips for FX-8805

Unit: mm

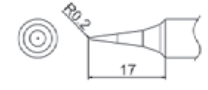
T19-B Shape-B 	T19-B2 Shape-2B 	T19-C3 Shape-3C 	T19-C4 Shape-4C 	T19-C65 Shape-6.5C 
T19-D24 Shape-2.4D 	T19-D32 Shape-3.2D 	T19-D5 Shape-5D 	T19-D65 Shape-6.5D 	T19-I Shape-I 

High Performance Soldering Station

FX-951 ESD SAFE

High Performance Soldering Station **Digital**

Tip not included

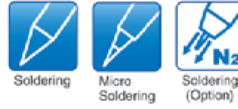

- Compact high-power thermally-controlled soldering iron
- Informs you of errors by a warning buzzer or display

FX-950 ESD SAFE

High Performance Soldering Station **Analog**

Tip not included



- Analog type high-power thermally-controlled soldering iron
- “Lock key” can lock the temperature setting.
- Informs you of various errors by a lamp

Features

Thermal recovery graph (comparison of HAKKO products)

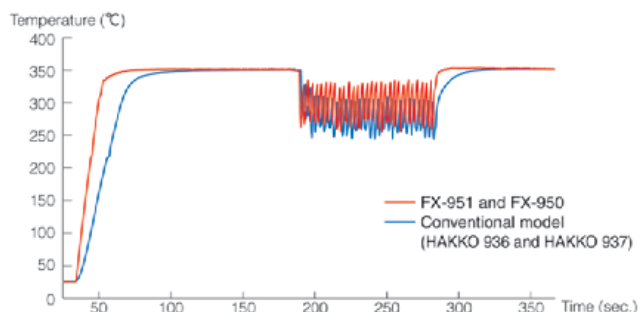

Test criteria

Measurement method	A thermocouple is mounted on the tip and the tip temperature is measured when soldering $\phi 1.6$ mm \times 5 mm solder to paper phenol copper board once every 3 seconds.
Board	Paper phenol copper board.
Temperature setting	350°C
Solder	Lead-free solder (Sn/Ag/Cu), diameter: 1.6 mm \times 5 mm

Connectable with micro soldering iron

For micro soldering applications under a microscope

FM-2032 55W

Micro Soldering Iron

Tip not included

Please see the optional tips on P.51.



N₂ Soldering is available with optional parts (P.47 & P.51).

Connectable with N₂ soldering iron

To improve solder wettability and spreadability

FM-2026 55W

N₂ Soldering Iron

Tip not included

Please see the optional tips on P.51.



For further details, see the N₂ system (P.46 & P.47).

Composite tip

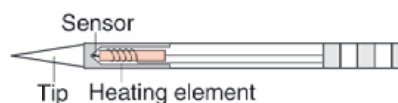

The composite tip with an integrated heating element and sensor offers superior thermal responsivity and thermal recovery.

Specifications

Model No.	FX-951	FX-950
Power consumption	75 W	
Temperature range	200 to 450°C	
Temperature stability	±5°C at idle temperature	

Station

Output voltage	AC 24 V
Dimensions	FX-951: 80 (W) \times 130 (H) \times 131 (D) mm FX-950: 80 (W) \times 118 (H) \times 138 (D) mm
Weight	1.2 kg

Soldering Iron

Power consumption	70 W (24 V)
Tip to ground resistance	<2 Ω
Tip to ground potential	<2 mV
Heating element	Composite heater
Cord length	1.2 m
Total length*	188 mm (with 2.4D tip)
Weight*	30 g (with 2.4D tip)

* Without cord

Model No.	FM-2032	FM-2026
Power consumption	48 W (24 V)	70 W (24 V)
Temperature range	200 to 450°C	
Tip to ground resistance	<2 Ω	
Tip to ground potential	<2 mV	
Heating element	Composite heater	
Cord length	1.3 m	1.2 m
Total length	170 mm* (with 1D tip)	205 mm** (with 2.4D tip)
Weight	14 g* (with 1D tip)	45 g** (with 2.4D tip and nozzle assembly C)

* Without cord ** Without cord and tube *** Use FM-2026 below 400°C.

Packing List













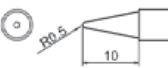
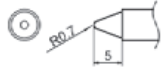

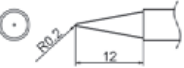
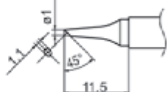
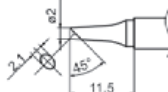

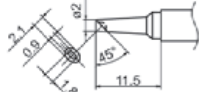

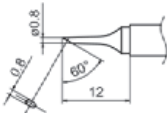
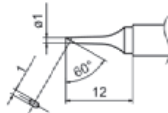
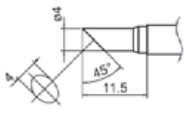





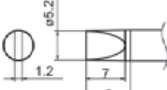

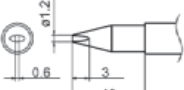
FX-951	Station, Handpiece (FM-2028), Control card, Power cord, Connecting cable, Heat resistant pad, Iron holder, Instruction manual
FX-950	Station, Handpiece (FM-2028), Lock key, Heat resistant pad, Iron holder, Instruction manual
FM-2032 (Conversion kit)	Handpiece, Heat resistant pad, Iron holder, Connecting cable, Instruction manual
FM-2026 (Conversion kit)	Handpiece, Sleeve cover, Sleeve assembly (yellow), Heat resistant pad, Iron holder, Connecting cable, Instruction manual

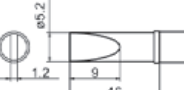
High Performance Soldering Station

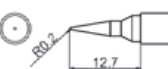
Optional Tips for FM-2028

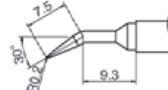
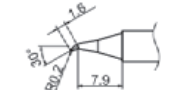
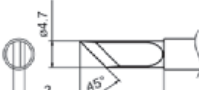
Unit: mm

Standard type

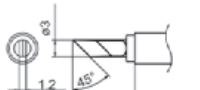
					
B	T12-B Shape-B 	T12-B2 Shape-0.5B 	T12-B3 Shape-0.7B 	T12-B4 Shape-0.4B 	T12-BL Shape-BL 
BC	T12-BC1 Shape-1BC T12-BCF1* 	T12-BC2 Shape-2BC T12-BCF2* 	T12-BC3 Shape-3BC T12-BCF3* 	T12-BCM2 Shape-2BC Bevel with indent 	T12-BCM3 Shape-3BC Bevel with indent 
C	T12-C08 Shape-0.8C 	T12-C1 Shape-1C 	T12-C4 Shape-4C T12-CF4* 		
D	T12-D08 Shape-0.8D 	T12-D12 Shape-1.2D 	T12-D16 Shape-1.6D 	T12-D24 Shape-2.4D 	T12-D4 Shape-4D 
	T12-D52 Shape-5.2D 	T12-DL08 Shape-0.8DL 	T12-DL12 Shape-1.2DL 	T12-DL32 Shape-3.2DL 	T12-DL52 Shape-5.2DL 
I	T12-I Shape-I 	T12-IL Shape-IL 	T12-ILS Shape-ILS 		
J	T12-J02 Shape-0.2J 	T12-JL02 Shape-0.2JL 	T12-JS02 Shape-0.2JS 		
K	T12-K Shape-K 	T12-KF Shape-KF 	T12-KL Shape-KL 	T12-KR Shape-KR 	T12-KU Shape-KU 

* These tips are tinned on the soldering surface only.

Concave type

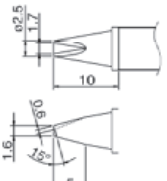
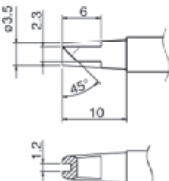
T12-1610 	T12-1612 
--	--

SMD type

Quad	T12-1201 Quad 13.6 x 8.5 	T12-1202 Quad 10.3 x 10.3 	T12-1203 Quad 12.8 x 12.8 	T12-1204 Quad 17.9 x 17.9 	T12-1205 Quad 23.4 x 17.3
	T12-1206 Quad 22.5 x 16.5 	T12-1207 Quad 15.5 x 15.5 	T12-1208 Quad 15.8 x 15.8 	T12-1209 Quad 8.4 x 8.4 	
Tunnel	T12-1001 Tunnel 5.1 x 4.6 	T12-1002 Tunnel 5.1 x 10.4 	T12-1003 Tunnel 9.5 x 18.3 	T12-1004 Tunnel 9.5 x 15.8 	T12-1005 Tunnel 9.5 x 13.2
	T12-1006 Tunnel 6.9 x 11.4 	T12-1007 Tunnel 7.9 x 18.8 	T12-1008 Tunnel 19.5 x 10.2 	T12-1009 Tunnel 13.4 x 20.5 	T12-1010 Tunnel 19.5 x 12
Spatula	T12-1401 Spatula 10.4 	T12-1402 Spatula 15.7 	T12-1403 Spatula 21.2 	T12-1404 Spatula 25 	T12-1405 Spatula 32
	T12-1406 Spatula 40 				

Long life type

T12-BZ Shape-B (Z) 	T12-B2Z Shape-0.5B (Z) 	T12-BC1Z Shape-1BC (Z) T12-BCF1Z* 	T12-BC2Z Shape-2BC (Z) T12-BCF2Z* 	T12-BC3Z Shape-3BC (Z) T12-BCF3Z*
T12-C4Z Shape-4C (Z) T12-CF4Z* 	T12-D12Z Shape-1.2D (Z) 	T12-D16Z Shape-1.6D (Z) 	T12-D24Z Shape-2.4D (Z) 	T12-D4Z Shape-4D (Z)
T12-KFZ Shape-KF (Z) 	T12-KRZ Shape-KR (Z) 			

* These tips are tinned on the soldering surface only.

Heavy duty type

T12-WB2 Shape-0.5WB 	T12-WD08 Shape-0.8WD 	T12-WD12 Shape-1.2WD 	T12-WD16 Shape-1.6WD 	T12-WD52 Shape-5.2WD 	T12-WI Shape-WI

FX-100 ESD SAFE



IH Soldering Station **Digital**

Tip not included



- Provides the heat to the tip effectively by an 'Induction heater'
- Unique "Power assist" feature that assists the thermal recovery performance of the soldering iron tip
- No calibration is required.
- Wide variety of tips available
- Meets or exceeds IPC J-STD-001 and ANSI ESD S20.20.

Optional Tips for FX-1001

Unit: mm

T31-XXBC1 "01" for 450°C (A: 71.5) "02" for 400°C (A: 68.5) "03" for 350°C (A: 68.5)				
T31-01BC1 Shape-1BC T31-02BC1 T31-03BC1 	T31-01BC28 Shape-2.8BC T31-02BC28 T31-03BC28 	T31-01BL Shape-BL T31-02BL T31-03BL 	T31-01D08 Shape-0.8D T31-02D08 T31-03D08 	T31-01D16 Shape-1.6D T31-02D16 T31-03D16
T31-01D24 Shape-2.4D T31-02D24 T31-03D24 	T31-01D52 Shape-5.2D T31-02D52 T31-03D52 	T31-01I Shape-I T31-02I T31-03I 	T31-01IL Shape-IL T31-02IL T31-03IL 	T31-01J02 Shape-0.2RSB T31-02J02 T31-03J02
T31-01JL02 Shape-0.2RLB T31-02JL02 T31-03JL02 	T31-01JS02 Shape-0.2RSSB T31-02JS02 T31-03JS02 	T31-01KU Shape-KU T31-02KU T31-03KU 	T31-01SBL Shape-SBL T31-02SBL T31-03SBL 	T31-01WD08 Shape-0.8WD T31-02WD08 T31-03WD08

Optional Tips for FX-1002

Unit: mm

T35-XXD06 "02" for 400°C (A: 64) "03" for 350°C (A: 64)				
T35-02D06 Shape-0.6D T35-03D06 	T35-02D1 Shape-1D T35-03D1 	T35-02I Shape-I T35-03I 	T35-02J Shape-J T35-03J 	T35-02KU Shape-KU T35-03KU

Features

IH (induction heater) for excellent thermal efficiency. Ideal for the most challenging soldering jobs.

FX-100 features IH (induction heater) that continuously powers the soldering iron and maintains the set temperature by automatically detecting even minute drops in temperature, plus HAKKO's proprietary "Power Assist" function.



FX-100 achieves powerful thermal recovery even with fine-shaped tips.

It provides excellent thermal responsiveness that conventional IH and sensor feedback systems cannot offer.

Boost function

To increase tip temperature by 5 to 10°C (depends on tip shape) for better working efficiency.

Connectable with micro soldering iron

For micro soldering applications under a microscope

FX-1002 556

Micro Soldering Iron

Tip not included



Packing List

FX-100	Station, Handpiece (FX-1001), Heat resistant pad, Power cord, Sleeve (green), Sleeve (gray), Cleaning wire, Iron holder, Instruction manual
FX-1002 (Conversion kit)	Handpiece, Sleeve (green), Heat resistant pad, Iron holder, Instruction manual

Interactive method by LCD display with 3 buttons

PROFILE

```
PROFILE 1
S: HAKKO-1
U: ID-123
S: 0.6 LEAD FREE
```

Station ID, user name and solder type can be registered.

TIP LOAD

```
TIP LOADS
approx.
000025 points
<RESET> <OK>
```

The soldering count is displayed.

TIP TIME

```
TIP TIME
0023 hours
<RESET> <OK>
```

The cumulative running time on the iron tip is displayed.

TIP TYPE and NORMAL MODE/BOOST MODE

```
<01>
N
■■■■■■
```

Visible tip type (01/02/03) and normal mode (N)/boost mode (B) on display

Specifications

Model No.	FX-100
Power consumption	28 W (85 W)
Temperature range	T31-01 Series: 450°C, T31-02 Series: 400°C T31-03 Series: 350°C
Temperature stability	±1.1°C

Station

Output power	50 W
Output frequency	13.56 MHz
Dimensions	127 (W) × 150 (H) × 167 (D) mm
Weight	3 kg

Soldering Iron

Tip to ground resistance	<2 Ω
Tip to ground potential	<2 mV
Heating element	IH (Induction heating)
Cord length	1.3 m
Total length*	190 mm with T31-02D24 or T31-03D24 tip 193 mm with T31-01D24 tip
Weight*	31 g (with T31-02D24 tip)

* Without cord

Model No.	FX-1002
Temperature range	T35-02 Series: 400°C, T35-03 Series: 350°C
Tip to ground resistance	<2 Ω
Tip to ground potential	<2 mV
Heating element	IH (Induction heating)
Cord length	1.3 m
Total length*	166 mm (with T35-02D1 tip)
Weight*	21 g (with T35-02D1 tip)

* Without cord

Heavy Duty Soldering Station

FX-838 ESD SAFE

Heavy Duty Soldering Iron Digital

Tip not included



- High powered 150 W soldering iron
- Best suited for soldering of power-supply boards, heat sinks, and shield cases
- Applicable also to the soldering of multilayer boards with micro components

Optional Tips for FX-8301

Unit: mm

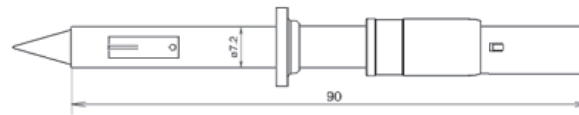

T20-B2 Shape-0.5B 	T20-BC2 Shape-2BC T20-BCF2* 	T20-BC3 Shape-3BC T20-BCF3* 	T20-BC4 Shape-4BC T20-BCF4* 	T20-BCM2 Shape-2BC Bevel with indent
T20-BCM3 Shape-3BC Bevel with indent 	T20-BL Shape-BL 	T20-BL2 Shape-2BL 	T20-BL3 Shape-3BL 	T20-C5 Shape-5C
T20-C6 Shape-6C 	T20-D16 Shape-1.6D 	T20-D24 Shape-2.4D 	T20-D32 Shape-3.2D 	T20-D6 Shape-6D
T20-J02 Shape-0.2J 	T20-K Shape-K 	T20-KU Shape-KU 	T20-1610 	T20-1611

* These tips are tinned on the soldering surface only.

Features

Graph of a comparison of the performance of FX-838 and a conventional station

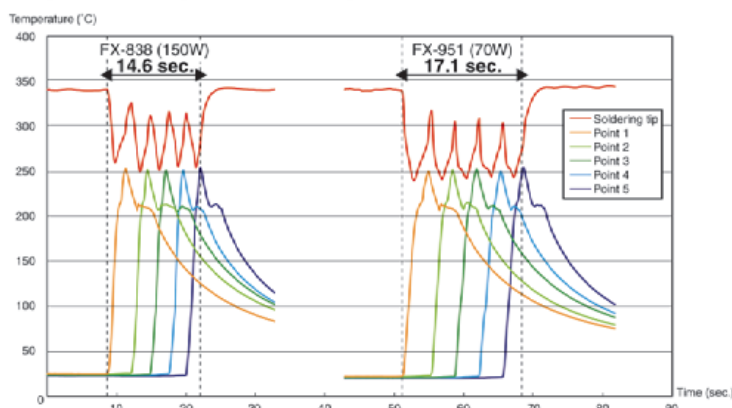

Test criteria

Measurement method	Thermocouples are mounted on the tip and the soldered portion on the board, and the time until the soldered portion reaches 250°C is measured for 5 points.
Board	Bakelite board
Component used	Terminal
Tip shape	Shape-1.6D
Temperature setting	340°C
Solder	Lead-free solder (Sn/Ag/Cu), diameter: 0.5 mm

Temperature preset mode

The temperature preset mode allows you to input three frequently-used temperatures in advance and recall them with one push of a button.

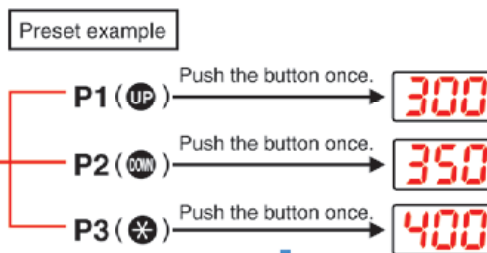

One push of a button can quickly recall each setting.

Connectable with N₂ soldering iron

To improve solder wettability and spreadability

FX-8302

N₂ Soldering Iron

Tip not included Please see the optional tips on P.50.



For further details, see the N₂ system (P.46 & P.47).

Packing List

FX-838	Station, Handpiece (FX-8301), Control card, Power cord, Heat resistant pad, Connecting cable, Iron holder, Instruction manual
FX-8302	Handpiece, Instruction manual

Specifications

Model No.	FX-838
Power consumption	158 W
Temperature range	200 to 500°C
Temperature stability	±5°C at idle temperature

Station

Output voltage	AC 27 V
Dimensions	110 (W) × 110 (H) × 205 (D) mm
Weight	3.2 kg

Soldering Iron

Power consumption	150 W (27 V)
Tip to ground resistance	<2 Ω
Tip to ground potential	<2 mV
Heating element	Ceramic heater
Cord length	1.2 m
Total length*	175 mm (with 2.4D tip)
Weight*	31 g (with 2.4D tip)

* Without cord

Model No.	FX-8302
Power consumption	150 W (27 V)
Temperature range	200 to 500°C
Tip to ground resistance	<2 Ω
Tip to ground potential	<2 mV
Heating element	Ceramic heater
Cord length	1.2 m
Total length*	195 mm (with 2.4D tip)
Weight*	41 g (with 2.4D tip and nozzle assembly D)

* Without cord and tube

FM-203 ESD SAFE

2-Port High Performance Rework Station Digital

Tip not included



- 2 handpieces can be connected at the same time.

FM-206 ESD SAFE

3-Port High Performance Rework Station Digital

Tip not included

Nozzle not included



- 3-port rework station that enables soldering, desoldering, and SMD rework all with a single unit
- Graphic LCD enables easy viewing and operation.

Handpiece Combination Examples

FM-203



Handpiece	Channel D connector	Channel S connector
FM-2027	○	○
FM-2022 ^{*1}	○	×
FM-2023 ^{*1}	○	×
FM-2024 ^{*2}	○	○
FM-2026 ^{*3}	○	○
FM-2030 ^{*1}	○	×
FM-2031 ^{*1, *3}	○	×
FM-2032	○	○

^{*1} When FM-2022, FM-2023, FM-2030 or FM-2031 is connected to the channel D connector, both channel connectors can't be used at the same time.
^{*2} When two FM-2024s are connected to the channel connectors, each FM-2024 must be connected to the desolder control box.
^{*3} For FM-2031 and FM-2026, each handpiece needs an N₂ generator (FX-780), flowmeter (FX-791), compressor, regulator, etc. For further details, see N₂ system (P.46 & P.47).

FM-206

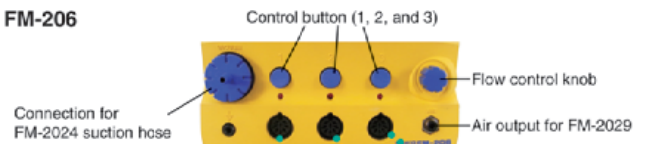

Handpiece	Receptacle 1	Receptacle 2	Receptacle 3
FM-2027	○	○	○
FM-2024	○ ^{*1}	○	○ ^{*1}
FM-2029	×	×	○
FM-2022	×	○	×
FM-2023	×	○	×
FM-2026	○	○	○
FM-2030	×	○	○
FM-2031	×	○ ^{*2}	○ ^{*2}
FM-2032	○	○	○

^{*1} FM-2024 can be connected to receptacle 2 and 3. However, only one FM-2024 can be used with the station.
^{*2} For FM-2031 and FM-2026, each handpiece needs an N₂ generator (FX-780), flowmeter (FX-791), compressor, regulator, etc. For further details, see N₂ system (P.46 & P.47).
NOTE: FM-2024 and FM-2029 can't be used at the same time.

Accessories

FM-2027 ㉔

Soldering Iron

Tip not included



FM-2026 ㉔

N₂ Soldering Iron

Tip not included



FM-2029 ㉔

Hot-Air Pencil

Nozzle not included



FM-2030 ㉔

Heavy Duty Soldering Iron

Tip not included



FM-2031 ㉔

N₂ Heavy Duty Soldering Iron

Tip not included



FM-2032 ㉔

Micro Soldering Iron

Tip not included

N₂ Soldering is available with optional parts (P.47 & P.51).

FM-2022 ㉔

SMD Hot Tweezers

Tip not included



FM-2023 ㉔

Mini SMD Hot Tweezers

Tip included



FM-2024 ㉔

Desoldering Tool

Nozzle not included



High Performance Rework Station and Accessories

Specifications

Model No.	FM-203
Power consumption	140 W
Temperature range	FM-2026/2027: 200 to 450°C FM-2022/2023: 200 to 400°C FM-2032: 200 to 450°C FM-2024: 350 to 450°C FM-2030/2031: 200 to 500°C
Temperature stability	±5°C at idle temperature

Station

Output voltage	AC 24 V
Dimensions	120 (W) × 120 (H) × 190 (D) mm
Weight	2.7 kg

Soldering Iron (FM-2027)

Power consumption	70 W (24 V)
Tip to ground resistance	<2 Ω
Tip to ground potential	<2 mV
Heating element	Composite heater
Cord length	1.2 m
Total length*	188 mm (with 2.4D tip)
Weight*	30 g (with 2.4D tip)

* Without cord

Model No.	FM-206
Power consumption	410 W (450 W, max.)
Temperature range	FM-2026/2027: 200 to 450°C FM-2022/2023: 200 to 400°C FM-2024: 350 to 450°C FM-2029: 100 to 550°C FM-2030: 200 to 500°C FM-2031: 200 to 500°C FM-2032: 200 to 450°C
Temperature stability	±5°C at idle temperature

Station

Output voltage	AC 24 V
Vacuum generator	Vacuum pump, cylinder type
Vacuum pressure	80 kPa (600 mmHg, max.)
Suction flow	14 L/min.
Air flow	6 L/min. (max.)
Dimensions	162 (W) × 136 (H) × 245 (D) mm
Weight*	6.2 kg

Soldering Iron (FM-2027)

Power consumption	70 W (24 V)
Tip to ground resistance	<2 Ω
Tip to ground potential	<2 mV
Heating element	Composite heater
Cord length	1.2 m
Total length*	188 mm (with 2.4D tip)
Weight*	30 g (with 2.4D tip)

Desoldering Tool (FM-2024)

Power consumption	70 W (24 V)
Nozzle to ground resistance	<2 Ω
Nozzle to ground potential	<2 mV
Heating element	Composite heater
Cord length	1.2 m
Total length*	180 mm (with ø1 mm nozzle)
Weight**	65 g (with ø1 mm nozzle)

Hot Air Handpiece (FM-2029)

Power consumption	140 W (24 V)
Nozzle to ground resistance	<2 Ω
Nozzle to ground potential	<2 mV
Heating element	Composite heater
Cord length	1.2 m
Total length***	232 mm (with ø4 mm nozzle)
Weight***	50 g (with ø4 mm nozzle)

* Without cord ** Without cord and hose *** Without cord and tube

Model No.	FM-2022
Power consumption	140 W (24 V)
Tip to ground resistance	<2 Ω
Tip to ground potential	<2 mV
Heating element	Composite heater
Cord length	1.2 m
Total length*	148 mm (with SOP 25L tip)
Weight*	64 g (with SOP 25L tip)

* Without cord

Model No.	FM-2023
Power consumption	140 W (24 V)
Tip to ground resistance	<2 Ω
Tip to ground potential	<2 mV
Heating element	Composite heater
Standard tip	Shape-I: 2 pcs/set (No.T9-I)
Cord length	1.2 m
Total length*	117 mm (with I tip)
Weight*	37 g (with I tip)

* Without cord

Model No.	FM-2024
-----------	---------

Desoldering Tool

Power consumption	70 W (24 V)
Nozzle to ground resistance	<2 Ω
Nozzle to ground potential	<2 mV
Heating element	Composite heater
Cord length	1.2 m
Total length**	180 mm (with ø1 mm nozzle)
Weight**	65 g (with ø1 mm nozzle)

Desolder Control Box

Power consumption	12 W (24 V)
Vacuum generator	Ejector type
Vacuum pressure	93 kPa (700 mmHg, max.)
Suction flow	20 L/min.
Nozzle to ground potential	<2 mV
Applied air pressure	490 kPa (5 kgf/cm ²) While in use (trigger or button is pressed)
Compressed air consumption	46 L/min.
Outer dimensions	119 (W) × 45 (H) × 172 (D) mm
Weight*	1.2 kg

* Without cord ** Without cord and hose

Model No.	FM-2026
Power consumption	70 W (24 V)
Tip to ground resistance	<2 Ω
Tip to ground potential	<2 mV
Heating element	Composite heater
Cord length	1.2 m
Total length**	205 mm (with 2.4D tip)
Weight**	45 g (with 2.4D tip and nozzle assembly C)

* Use this N₂ soldering iron below 400°C.

** Without cord and tube

Model No.	FM-2027
Power consumption	70 W (24 V)
Tip to ground resistance	<2 Ω
Tip to ground potential	<2 mV
Heating element	Composite heater
Cord length	1.2 m
Total length*	188 mm (with 2.4D tip)
Weight*	30 g (with 2.4D tip)

* Without cord

Specifications

Model No.	FM-2030
Power consumption	140 W (24 V)
Tip to ground resistance	<2 Ω
Tip to ground potential	<2 mV
Heating element	Composite heater
Cord length	1.3 m
Total length*	224 mm (with 2.4D tip)
Weight*	41 g (with 2.4D tip)

* Without cord

Model No.	FM-2032
Power consumption	48 W (24 V)
Tip to ground resistance	<2 Ω
Tip to ground potential	<2 mV
Heating element	Composite heater
Cord length	1.3 m
Total length*	170 mm (with 1D tip)
Weight*	14 g (with 1D tip)

* Without cord

Model No.	FM-2031
Power consumption	140 W (24 V)
Tip to ground resistance	<2 Ω
Tip to ground potential	<2 mV
Heating element	Composite heater
Cord length	1.2 m
Total length*	231 mm (with 2.4D tip)
Weight*	47 g (with 2.4D tip and nozzle assembly E)

* Without cord and tube

Packing List

FM-203	Station, Handpiece (FM-2027), Sleeve assembly, Connecting cable, Power cord, Control card, Iron holder, Tip tray, Heat resistant pad, Instruction manual
FM-206	Station, Power cord, Tip tray, Desoldering tool (FM-2024), Handle (for gun configuration for FM-2024), Iron holder (for FM-2024), Ceramic paper filter (10 pcs; for FM-2024), Nozzle remover (for FM-2024), Cleaning drill for heating element (for FM-2024), Connecting cable (for FM-2024), Handpiece (FM-2027), Iron holder (for FM-2027), Heat resistant pad (for FM-2027), Connecting cable (for FM-2027), Hot air handpiece (FM-2029), Iron holder (for FM-2029), Heat resistant pad (for FM-2029), Connecting cable (for FM-2029), Instruction manual
FM-2022 (Conversion kit)	Parallel remover, Heat resistant pad, Iron holder, Connecting cable, Instruction manual
FM-2023 (Conversion kit)	Mini parallel remover, Soldering tip (T9-I), Heat resistant pad, Iron holder, Component bed, Connecting cable, Instruction manual

FM-2024 (Conversion kit, with DCB)	Desoldering tool, Handle (for gun configuration), Desoldering control box, Filter pipe assembly, Iron holder, Cleaning drill for heating element, Nozzle remover, Ceramic paper filter (10 pcs), Connecting cable, Instruction manual
FM-2026 (Conversion kit)	Handpiece, Sleeve cover, Sleeve assembly (yellow), Heat resistant pad, Iron holder, Connecting cable, Instruction manual
FM-2027 (Conversion kit)	Handpiece, Sleeve assembly (yellow), Heat resistant pad, Iron holder, Connecting cable
FM-2029 (Conversion kit)	Handpiece (hot air), Handpiece holder, Heat resistant pad, Connecting cable, Instruction manual
FM-2030 (Conversion kit)	Handpiece (soldering), Heat resistant pad, Iron holder, Connecting cable, Instruction manual
FM-2031 (Conversion kit)	Handpiece (soldering), Heat resistance pad, Iron holder, Connecting cable, Instruction manual
FM-2032 (Conversion kit)	Handpiece, Heat resistant pad, Iron holder, Connecting cable, Instruction manual

FM-2029 Features

Securely and easily remove 10 × 10 (mm) chips.

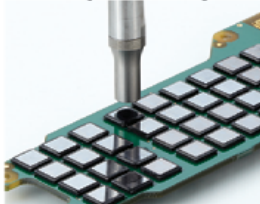

FM-2032 Size

Unit: mm



FM-2030 Features

Graph of a comparison of the performance of FM-2027 (70 W) and FM-2030 (140 W)

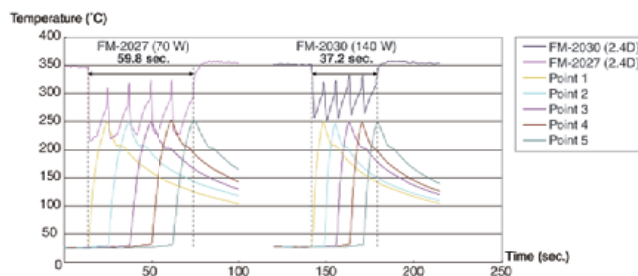

Test criteria

Test method	Solder at 5 points and measure the time until the temperature of the workpiece reaches 250°C.
Board	Bakelite board
Component used	Screw
Tip shape	Shape-2.4D
Temperature setting	350°C
Solder	Lead-free solder (Sn/Ag/Cu), diameter: 1 mm













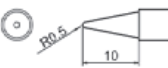
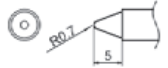

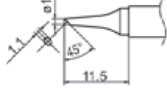
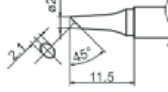
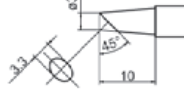
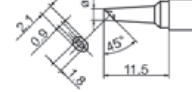
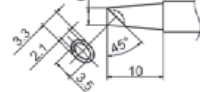

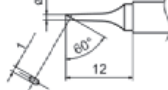

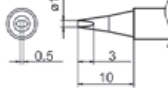
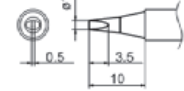
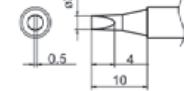
High Performance Rework Station and Accessories

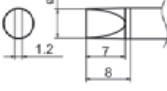
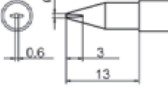
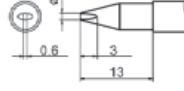
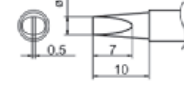
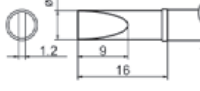
Optional Tips for FM-2027

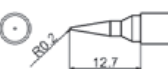
Unit: mm

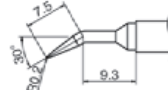
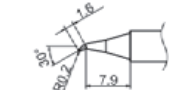

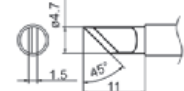
Standard type



					
B	T12-B Shape-B 	T12-B2 Shape-0.5B 	T12-B3 Shape-0.7B 	T12-B4 Shape-0.4B 	T12-BL Shape-BL 
BC	T12-BC1 Shape-1BC T12-BCF1* 	T12-BC2 Shape-2BC T12-BCF2* 	T12-BC3 Shape-3BC T12-BCF3* 	T12-BCM2 Shape-2BC Bevel with indent 	T12-BCM3 Shape-3BC Bevel with indent 
C	T12-C08 Shape-0.8C 	T12-C1 Shape-1C 	T12-C4 Shape-4C T12-CF4* 		
D	T12-D08 Shape-0.8D 	T12-D12 Shape-1.2D 	T12-D16 Shape-1.6D 	T12-D24 Shape-2.4D 	T12-D4 Shape-4D 
	T12-D52 Shape-5.2D 	T12-DL08 Shape-0.8DL 	T12-DL12 Shape-1.2DL 	T12-DL32 Shape-3.2DL 	T12-DL52 Shape-5.2DL 
I	T12-I Shape-I 	T12-IL Shape-IL 	T12-ILS Shape-ILS 		
J	T12-J02 Shape-0.2J 	T12-JL02 Shape-0.2JL 	T12-JS02 Shape-0.2JS 		
K	T12-K Shape-K 	T12-KF Shape-KF 	T12-KL Shape-KL 	T12-KR Shape-KR 	T12-KU Shape-KU 

* These tips are tinned on the soldering surface only.

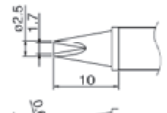
Concave type

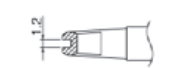
T12-1610 	T12-1612 
	

SMD type

Quad	T12-1201 Quad 13.6 x 8.5 	T12-1202 Quad 10.3 x 10.3 	T12-1203 Quad 12.8 x 12.8 	T12-1204 Quad 17.9 x 17.9 	T12-1205 Quad 23.4 x 17.3
	T12-1206 Quad 22.5 x 16.5 	T12-1207 Quad 15.5 x 15.5 	T12-1208 Quad 15.8 x 15.8 	T12-1209 Quad 8.4 x 8.4 	
	T12-1001 Tunnel 5.1 x 4.6 	T12-1002 Tunnel 5.1 x 10.4 	T12-1003 Tunnel 9.5 x 18.3 	T12-1004 Tunnel 9.5 x 15.8 	T12-1005 Tunnel 9.5 x 13.2
	T12-1006 Tunnel 6.9 x 11.4 	T12-1007 Tunnel 7.9 x 18.8 	T12-1008 Tunnel 19.5 x 10.2 	T12-1009 Tunnel 13.4 x 20.5 	T12-1010 Tunnel 19.5 x 12
Spatula	T12-1401 Spatula 10.4 	T12-1402 Spatula 15.7 	T12-1403 Spatula 21.2 	T12-1404 Spatula 25 	T12-1405 Spatula 32
	T12-1406 Spatula 40 				

Long life type

T12-BZ Shape-B (Z) 	T12-B2Z Shape-0.5B (Z) 	T12-BC1Z Shape-1BC (Z) T12-BCF1Z* 	T12-BC2Z Shape-2BC (Z) T12-BCF2Z* 	T12-BC3Z Shape-3BC (Z) T12-BCF3Z*
T12-C4Z Shape-4C (Z) T12-CF4Z* 	T12-D12Z Shape-1.2D (Z) 	T12-D16Z Shape-1.6D (Z) 	T12-D24Z Shape-2.4D (Z) 	T12-D4Z Shape-4D (Z)
T12-KFZ Shape-KF (Z) 	T12-KRZ Shape-KR (Z) 			

* These tips are tinned on the soldering surface only.

Heavy duty type

T12-WB2 Shape-0.5WB 	T12-WD08 Shape-0.8WD 	T12-WD12 Shape-1.2WD 	T12-WD16 Shape-1.6WD 	T12-WD52 Shape-5.2WD 	T12-WI Shape-WI

High Performance Rework Station and Accessories

Optional Tips for FM-2032

Unit: mm

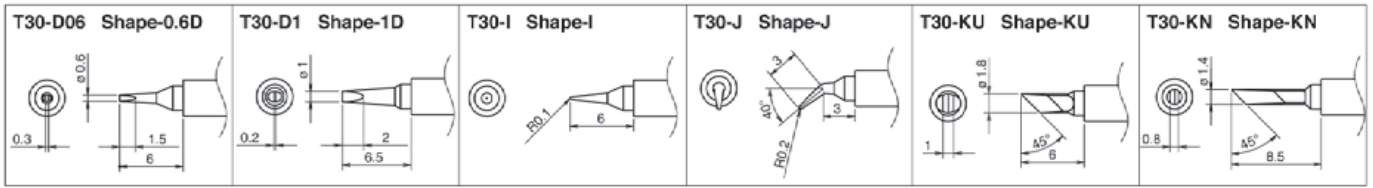

Optional Tips for FM-2022

Unit: mm

CHIP

*1 set: 2 pcs

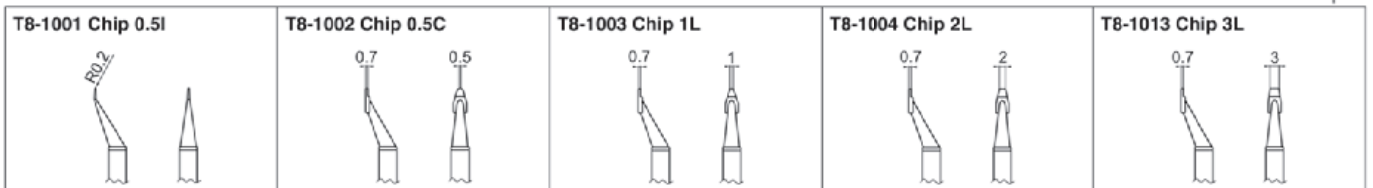

SOP

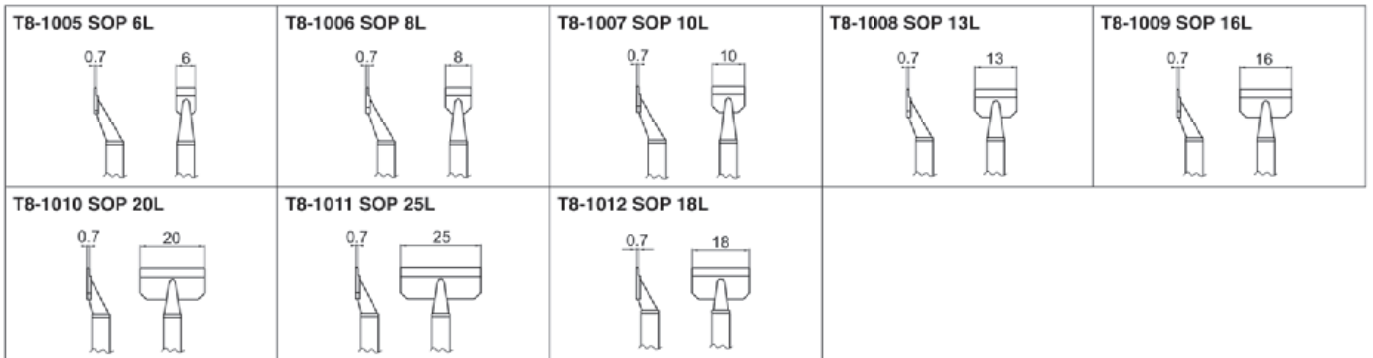

Replacement Tips for FM-2023

Unit: mm

CHIP

*1 set: 2 pcs

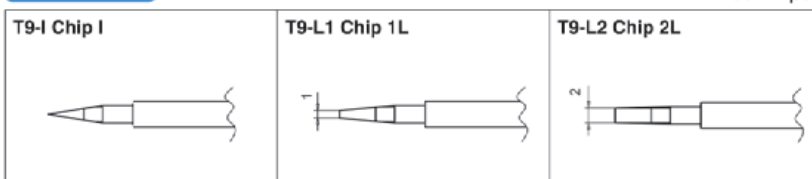

Optional Tips for FM-2030

Unit: mm

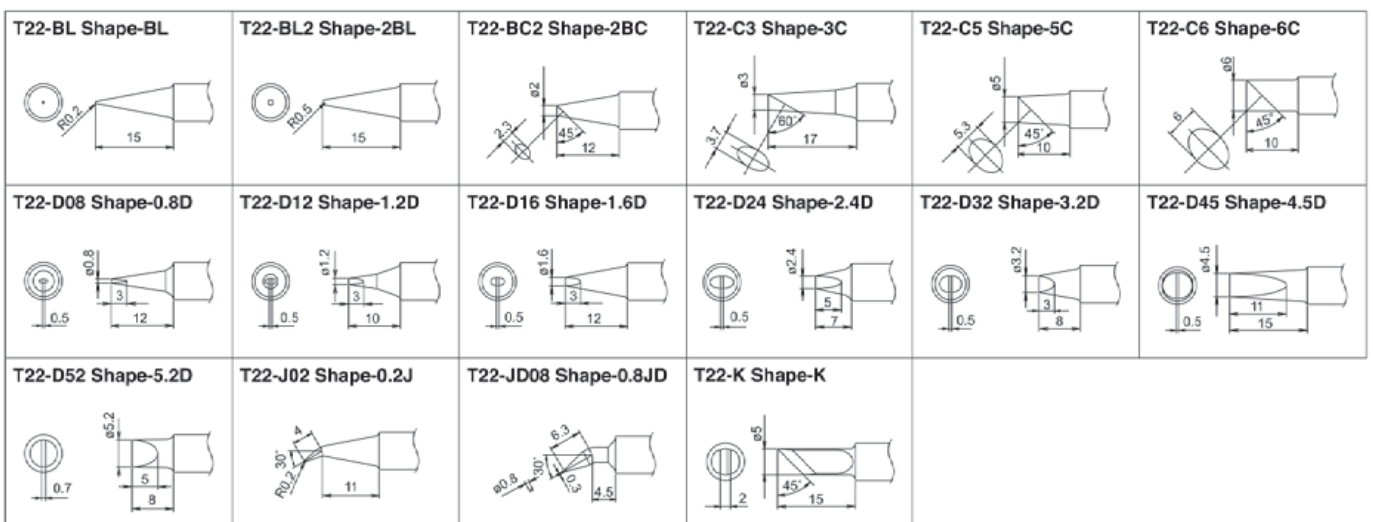

Optional Nozzles for FM-2024

Unit: mm

<p>N1-06 Nozzle $\phi 0.6$</p>	<p>N1-08 Nozzle $\phi 0.8$</p>	<p>N1-10 Nozzle $\phi 1$</p>	<p>N1-13 Nozzle $\phi 1.3$</p>	<p>N1-16 Nozzle $\phi 1.6$</p>
<p>N1-20 Nozzle $\phi 2$</p>	<p>N1-23 Nozzle $\phi 2.3$</p>	<p>N1-L10 Nozzle $\phi 1$ long</p>		

Optional Nozzles for FM-2029

Unit: mm

		ϕA	ϕB
N4-01 Nozzle $\phi 2$		2	2.5
N4-02 Nozzle $\phi 4$		4	5
N4-03 Nozzle $\phi 6$		6	7
N4-04 Nozzle $\phi 8$		8	9

Optional Tips for the FM-2026

Please see the optional tips on P.51.

Optional Tips for the FM-2031

Please see the optional tips on P.50.



FX-780 / FX-781

N₂ Generator



- Highest concentration of nitrogen gas: 99.9%
- Compact design reduces footprint.
- Large-capacity type accepts 2 soldering irons (FX-781).

FX-791

N₂ Flowmeter



- Flowmeter for N₂ soldering iron with flow control valve and regulator

- The preheating effect is achieved by passing nitrogen gas along the heating element in the hand piece.
- Improvement of wettability and spreadability
- Preventing oxidation

Connection Method

For two soldering irons

Large-capacity type : FX-781

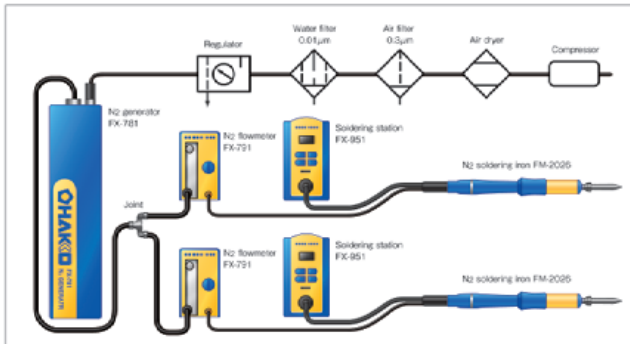

* It is capable to supply high concentration nitrogen of 97% at the output rate approx. 1L /min. (at air supply pressure of 0.5MPa)

For one soldering iron

Small-capacity type : FX-780
Large-capacity type : FX-781

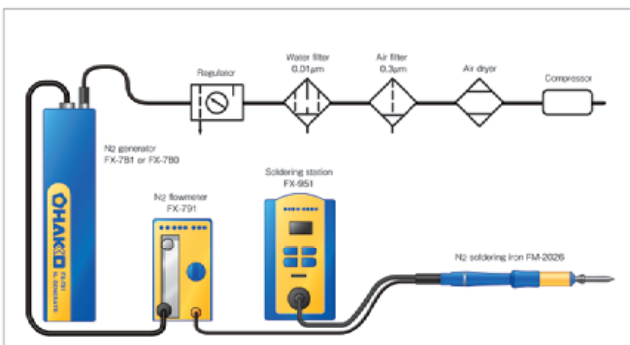

* It is capable to supply high concentration nitrogen of 99.9% at the output rate approx. 1L /min. (at air supply pressure of 0.7MPa)

Specifications

Model No.	FX-780	FX-781
Air supply pressure	0.3 to 0.7 MPa	
Concentration of generated N ₂	99.9% (max.)	
Amount of generated N ₂	1.5 L/min. (When compressed air of 0.5 MPa is supplied at 25°C, the concentration of the generated nitrogen is 98%.)	2.4 L/min. (When compressed air of 0.5 MPa is supplied at 25°C, the concentration of the generated nitrogen is 98%.)
Dimensions*	73 (W) × 282 (H) × 71 (L) mm	73 (W) × 407 (H) × 71 (L) mm
Weight**	1.5 kg	2 kg

* Without sockets and valve
** Without racks

Model No.	FX-791
Pressure of discharged gas	0.2 MPa (2 kgf/cm ²)
Gas flow	0.25 to 2.5 L/min.
Dimensions	70 (W) × 121 (H) × 134 (D) mm
Weight	600 g

Packing List

FX-780	Unit, Rack for unit (2 pcs), Instruction manual
FX-781	Unit, Racks for unit (4 pcs), Instruction manual
FX-791	Unit, Instruction manual

Applicable Soldering Station

N₂ Soldering Iron

FN-1102 95 W	FX-8003 260 W	FX-8302 150 W	FM-2031 140 W	FM-2032 48 W	FM-2026 70 W	FX-8802 65 W
IoT Capable	Heavy Duty		High Performance			All-Round
FN-1010	FX-801	FX-838	FM-206	FM-203	FX-951	FM-206
					FM-203	FM-204
					FX-950	
					* Use FM-2026 below 400°C.	
						FX-888D
						FX-889
						* Use FX-8802 below 450°C.

Effects of N₂ system

Heated N₂ gas discharged from the tip end produces three effects. As a result, solderability increases, which allows you to enjoy the following advantages.

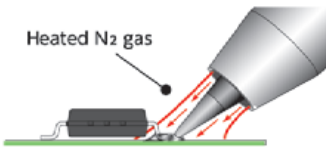

- Compatible with no-clean soldering (low-activity flux)
- Solves the insufficient heat supply problems which may occur during soldering of multilayer boards
- Reduces cracking in multilayer ceramic capacitors by thermal stress
- Reduces soldering time
- Relieves loads applied to heat-sensitive parts
- Reduces tip oxidation

Improving wettability

Heated N₂ gas preheats P.W.B.s and shuts out oxygen. As a result, it prevents the oxidation of solder and flux and improves wettability.

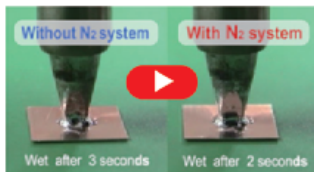

Preheating effect

Heated N₂ gas preheats the workpiece. As a result, even if the temperature setting is low, soldering can be finished in the same time as before.

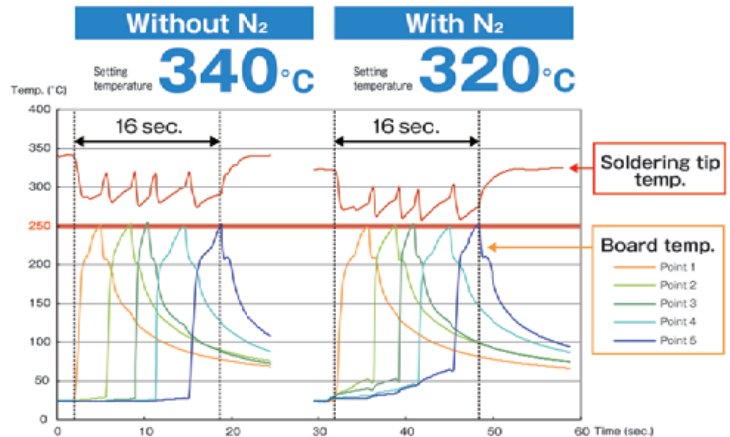

Preventing oxidation

Heated N₂ gas reduces the oxidation of tips (iron plating). As a result, the wettability of tips is improved.



Test criteria

- After applying power for 3 hours with the temperature set at 400°C, feed solder and perform cleaning, and then compare the conditions.

Test criteria

- Board: Paper phenol copper board
- Component: Connector
- Solder: Lead-free solder (Sn-3Ag-0.5Cu) Φ 0.5mm
- Tip shape: T12-D24 and T13-D24
- Measurement method: Measure the time until the workpiece reached to 250°C at 5-points

The three effects result in improved workability, quality stability and reduced running cost.

Optional Tips and Nozzle Assemblies for FN-1102

Tip and nozzle assembly are supplied separately. Please purchase a compatible nozzle assembly for your tip referring the chart below.

Unit: mm



T36-B Shape-0.2B 	T36-B2 Shape-0.5B 	T36-BL Shape-BL 	T36-BC1 Shape-1BC 	T36-BC2 Shape-2BC
B5233 Nozzle assembly A	B5234 Nozzle assembly B	B5234 Nozzle assembly B	B5235 Nozzle assembly C	B5234 Nozzle assembly B
T36-BC3 Shape-3BC 	T36-C1 Shape-1C 	T36-C4 Shape-4C 	T36-D08 Shape-0.8D 	T36-D16 Shape-1.6D
B5236 Nozzle assembly D	B5235 Nozzle assembly C	B5236 Nozzle assembly D	B5233 Nozzle assembly A	B5233 Nozzle assembly A
T36-D24 Shape-2.4D 	T36-DL32 Shape-3.2DL 	T36-D52 Shape-5.2D 	T36-I Shape-I 	T36-ILS Shape-ILS
B5233 Nozzle assembly A	B5237 Nozzle assembly E	B5237 Nozzle assembly E	B5233 Nozzle assembly A	B5235 Nozzle assembly C
T36-J02 Shape-0.2J 	T36-JS02 Shape-0.2JS 	T36-K Shape-K 		
B5234 Nozzle assembly B	B5233 Nozzle assembly A	B5237 Nozzle assembly E		

Optional Tips and Nozzle Assemblies for FX-8003

Tip and nozzle assembly are supplied separately. Please purchase a compatible nozzle assembly for your tip referring the chart below.

Unit: mm

Regular type

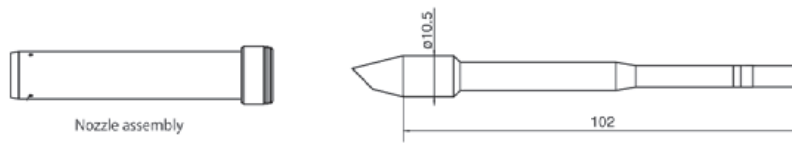

<p>T33-BC2 Shape-2BC</p>	<p>T33-BC3 Shape-3BC</p>	<p>T33-BC4 Shape-4BC</p>	<p>T33-BC5 Shape-5BC</p>	<p>T33-BC6 Shape-6BC</p>
B5070 Nozzle assembly B	B5070 Nozzle assembly B	B5069 Nozzle assembly A	B5069 Nozzle assembly A	B5069 Nozzle assembly A
<p>T33-D24 Shape-2.4D</p>	<p>T33-D32 Shape-3.2D</p>	<p>T33-D5 Shape-5D</p>	<p>T33-D6 Shape-6D</p>	<p>T33-1610</p>
B5070 Nozzle assembly B	B5069 Nozzle assembly A	B5069 Nozzle assembly A	B5069 Nozzle assembly A	B5070 Nozzle assembly B
<p>T33-1611</p>				
B5070 Nozzle assembly B				

Slim type

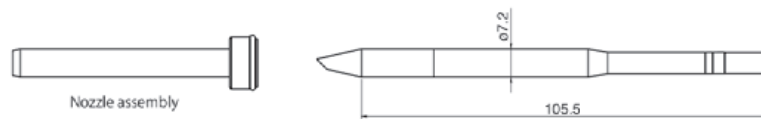









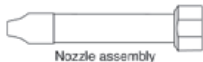

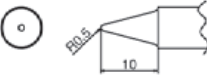
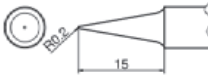
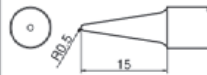

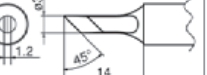
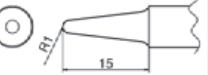
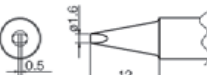
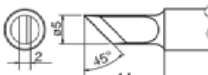



<p>T33-SSBC2 Shape-2SSBC</p>	<p>T33-SSBC3 Shape-3SSBC</p>	<p>T33-SSBC4 Shape-4SSBC</p>	<p>T33-SSBC5 Shape-5SSBC</p>	<p>T33-SSD16 Shape-1.6SSD</p>
B5239 Nozzle assembly C	B5239 Nozzle assembly C	B5240 Nozzle assembly D	B5240 Nozzle assembly D	B5239 Nozzle assembly C
<p>T33-SSD24 Shape-2.4SSD</p>	<p>T33-SSD32 Shape-3.2SSD</p>	<p>T33-SSD6 Shape-6SSD</p>	<p>T33-SS1610</p>	<p>T33-SS1611</p>
B5240 Nozzle assembly D	B5241 Nozzle assembly E	B5241 Nozzle assembly E	B5239 Nozzle assembly C	B5239 Nozzle assembly C

Optional Tips and Nozzle Assemblies for FX-8302

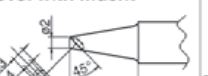
Tip and nozzle assembly are supplied separately. Please purchase a compatible nozzle assembly for your tip referring the chart below.

Unit: mm











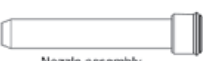

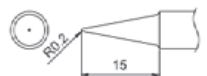



 					
T20-B2 Shape-0.5B  B3121 Nozzle assembly A	T20-BL Shape-BL  B3121 Nozzle assembly A	T20-BL2 Shape-2BL  B3121 Nozzle assembly A	T20-J02 Shape-0.2J (0.2RSB)  B3122 Nozzle assembly B	T20-KU Shape-KU  B3122 Nozzle assembly B	T20-BL3 Shape-3BL  B3123 Nozzle assembly C
T20-D16 Shape-1.6D  B3123 Nozzle assembly C	T20-K Shape-K  B3123 Nozzle assembly C	T20-BC2 Shape-2BC T20-BCF2*  B3124 Nozzle assembly D	T20-BC3 Shape-3BC T20-BCF3*  B3124 Nozzle assembly D	T20-BC4 Shape-4BC T20-BCF4*  B3124 Nozzle assembly D	T20-C5 Shape-5C  B3124 Nozzle assembly D
T20-C6 Shape-6C  B3124 Nozzle assembly D	T20-D24 Shape-2.4D  B3124 Nozzle assembly D	T20-D32 Shape-3.2D  B3124 Nozzle assembly D	T20-BCM2 Shape-2BC Bevel with indent  B3124 Nozzle assembly D	T20-BCM3 Shape-3BC Bevel with indent  B3124 Nozzle assembly D	T20-D6 Shape-6D  B3561 Nozzle assembly E
T20-1610  B3124 Nozzle assembly D		T20-1611  B3124 Nozzle assembly D			

* These tips are tinned on the soldering surface only.

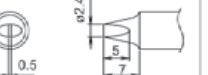
Optional Tips and Nozzle Assemblies for FM-2031

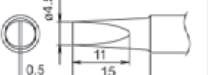
Tip and nozzle assembly are supplied separately. Please purchase a compatible nozzle assembly for your tip referring the chart below.

Unit: mm

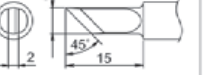
 					
T22-BL Shape-BL  B3121 Nozzle assembly A	T22-BL2 Shape-2BL  B3121 Nozzle assembly A	T22-BC2 Shape-2BC  B3121 Nozzle assembly A	T22-C3 Shape-3C  B3121 Nozzle assembly A	T22-C5 Shape-5C  B3124 Nozzle assembly D	T22-C6 Shape-6C  B3124 Nozzle assembly D
T22-D08 Shape-0.8D  B3123 Nozzle assembly C	T22-D12 Shape-1.2D  B3121 Nozzle assembly A	T22-D16 Shape-1.6D  B3123 Nozzle assembly C	T22-D24 Shape-2.4D  B3561 Nozzle assembly E	T22-D32 Shape-3.2D  B3124 Nozzle assembly D	T22-D45 Shape-4.5D  B3124 Nozzle assembly D
T22-D52 Shape-5.2D  B3124 Nozzle assembly D	T22-J02 Shape-0.2J  B3121 Nozzle assembly A	T22-JD08 Shape-0.8JD  B3561 Nozzle assembly E	T22-K Shape-K  B3123 Nozzle assembly C		

Optional Tips and Nozzle Assemblies for FM-2032

Tip and nozzle assembly are supplied separately. Please purchase a compatible nozzle assembly for your tip referring the chart below.

Unit: mm

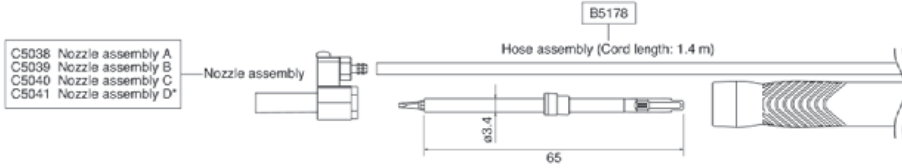

T30-D1 Shape-1D 	T30-D06 Shape-0.6D 	T30-I Shape-I 	T30-J Shape-J 	T30-KU Shape-KU 	T30-KN Shape-KN
C5038 Nozzle assembly A C5041 Nozzle assembly D*	C5038 Nozzle assembly A C5041 Nozzle assembly D*	C5038 Nozzle assembly A C5041 Nozzle assembly D*	C5040 Nozzle assembly C C5041 Nozzle assembly D*	C5038 Nozzle assembly A C5041 Nozzle assembly D*	C5039 Nozzle assembly B C5041 Nozzle assembly D*

* Shorter nozzle design provides better visibility.
For further information, visit our website.

Optional Tips and Nozzle Assemblies for FM-2026

Tip and nozzle assembly are supplied separately. Please purchase a compatible nozzle assembly for your tip referring the chart below.

Unit: mm

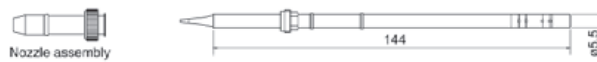

T13-B2 Shape-0.5B 	T13-BL Shape-BL 	T13-BC1 Shape-1BC T13-BCF1* 	T13-BC2 Shape-2BC T13-BCF2* 	T13-BC3 Shape-3BC T13-BCF3* 	T13-D08 Shape-0.8D
B2708 Nozzle assembly C	B2898 Nozzle assembly E	B2899 Nozzle assembly F	B2706 Nozzle assembly A	B2900 Nozzle assembly G	B2709 Nozzle assembly D
T13-D16 Shape-1.6D 	T13-D24 Shape-2.4D 	T13-J02 Shape-0.2J 	T13-KF Shape-KF 	T13-KR Shape-KR 	T13-KU Shape-KU
B2708 Nozzle assembly C	B2708 Nozzle assembly C	B2707 Nozzle assembly B	B2923 Nozzle assembly J	B2902 Nozzle assembly I	B2901 Nozzle assembly H
T13-BCM2 Shape-2BC Bevel with indent 	T13-BCM3 Shape-3BC Bevel with indent 	* These tips are tinned on the soldering surface only.			
B2706 Nozzle assembly A	B2900 Nozzle assembly G				

Replacement Tips and Nozzle Assemblies for FX-8802

Tip and nozzle assembly are supplied separately. Please purchase a compatible nozzle assembly for your tip referring the chart below.

Unit: mm



T18-B Shape-B 	T18-C05 Shape-0.5C 	T18-C1 Shape-1C T18-CF1* 	T18-C2 Shape-2C T18-CF2* 	T18-C3 Shape-3C T18-CF3* 	T18-D08 Shape-0.8D
B3662 Nozzle assembly A	B3664 Nozzle assembly C	B3664 Nozzle assembly C	B3662 Nozzle assembly A	B3663 Nozzle assembly B	B3662 Nozzle assembly A
T18-D12 Shape-1.2D 	T18-D16 Shape-1.6D 	T18-D24 Shape-2.4D 	T18-K Shape-K 	T18-I Shape-I 	
B3662 Nozzle assembly A	B3663 Nozzle assembly B	B3663 Nozzle assembly B	B3665 Nozzle assembly D	B3664 Nozzle assembly C	
					* These tips are tinned on the soldering surface only.

FX-600

Temperature Adjustable Soldering Iron

Tip included



- Adjustable temperature range: 200 to 500°C

FX-601

Heavy Duty Temperature Adjustable Soldering Iron

Tip included



- Maximum temperature: 540°C

Features

Superior heat conductivity

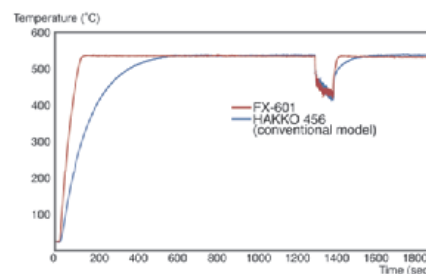
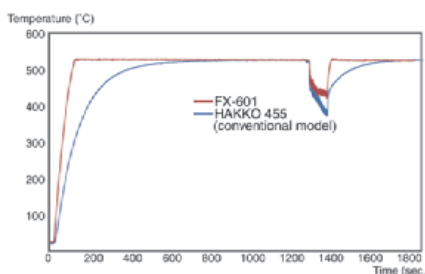
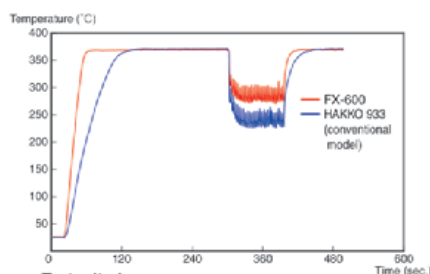

Test criteria

- Temperature of soldering iron with a diameter 1.6 x 5 mm piece of solder applied once every 3 seconds to paper phenol copper board.
- Lead-free solder is used.

Detach the control knob and lock the temperature setting.



Turn the CAL knob to attain a more accurate temperature.

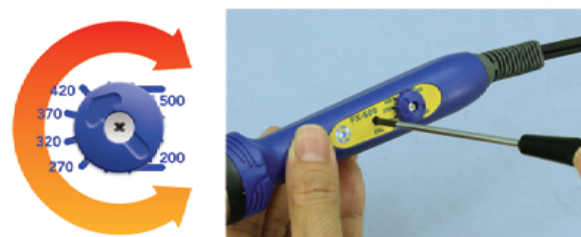

* Accurate temperature control can be performed even outside the scale.

Specifications

Model No.	FX-600	FX-601
Power consumption	50 W (100 V), 59 W (110 V), 74 W (120 V), 43 W (220 V), 47 W (230 V), 51 W (240 V)	47 W (100 V), 56 W (110 V), 67 W (120 V), 42 W (220 V), 46 W (230 V), 50 W (240 V)
Temperature range	200 to 500°C	240 to 540°C
Temperature stability	±1°C at idle temperature	±1°C at idle temperature
Tip to ground resistance	<2 Ω	<2 Ω
Tip to ground potential	<2 mV	<2 mV
Heating element	Ceramic heater	Ceramic heater
Standard tip	Shape-B (No. T18-B)	Shape-2B (No. T19-B2)
Total length*	233 mm (with B tip)	237 mm (with 2B tip)
Weight*	61 g (with B tip)	68 g (with 2B tip)

* Without cord

Packing List

FX-600	Unit, Lock key, Instruction manual
FX-601	Unit, Lock key, Instruction manual



FX-600 with 605M

Option

Part No.	Name	Specifications
FH300-81	Iron holder	With cleaning sponge
633-01	Iron holder	With 599B
633-02	Iron holder	With cleaning sponge
605M	Iron cover	-
B3720	Tip enclosure	With nut, required when converting from FX-600 to FX-601
B3730	Nut and tip enclosure	Required when converting from FX-601 to FX-600

* For information on the iron holders, see P.72.

Replacement Tips for FX-600

Unit: mm

T18-B Shape-B 	T18-BL Shape-BL 	T18-C05 Shape-0.5C 	T18-C08 Shape-0.8C 	T18-C1 Shape-1C T18-CF1*
T18-C2 Shape-2C T18-CF2* 	T18-C3 Shape-3C T18-CF3* 	T18-C4 Shape-4C T18-CF4* 	T18-C5 Shape-5C 	T18-CF15* Shape-1.5C
T18-CSF25* Shape-2.5CS 	T18-D08 Shape-0.8D 	T18-D12 Shape-1.2D 	T18-D16 Shape-1.6D 	T18-D24 Shape-2.4D
T18-D32 Shape-3.2D 	T18-DL12 Shape-1.2DL 	T18-DL2 Shape-2DL 	T18-DL32 Shape-3.2DL 	T18-I Shape-I
T18-BR02 Shape-0.2BR 	T18-K Shape-K 	T18-S3 Shape-S3 	T18-S4 Shape-S4 	T18-S6 Shape-S6
T18-S9 Shape-S9 	T18-SB Shape-SB 			

* These tips are tinned on the soldering surface only.

Replacement Tips for FX-601

Unit: mm

T19-B Shape-B 	T19-B2 Shape-2B 	T19-C3 Shape-3C 	T19-C4 Shape-4C 	T19-C65 Shape-6.5C
T19-D24 Shape-2.4D 	T19-D32 Shape-3.2D 	T19-D5 Shape-5D 	T19-D65 Shape-6.5D 	T19-I Shape-I

DASH

Ceramic Heater Soldering Iron

Tip included



- An entry model of ceramic heater soldering iron
- Ideal for electronic circuit assembly



Packing List

FX-650	Unit
--------	------

Features

Slim handle improves your work efficiency!



Simple and easy tip replacement



Quick change just loosening a screw

Specifications

Model No.	FX-650
Power consumption	15 to 16 W
Heating element	Ceramic heater
Standard tip	Shape-B (No.T34-B)
Total length*	224 mm
Weight*	60 g (with B tip)

* Without cord

Option

Part No.	Name	Specifications
FH300-81	Iron holder	With cleaning sponge
633-01	Iron holder	With 599B
633-02	Iron holder	With cleaning sponge
605M	Iron cover	-

* For information on the iron holders, see P.72.



No.605M (with FX-650)

Replacement Tips for DASH

Unit: mm

T34-B Shape-B 	T34-C08 Shape-0.8C 	T34-C2 Shape-2C 	T34-C3 Shape-3C 	T34-C4 Shape-4C
T34-D32 Shape-3.2D 	T34-I Shape-I 			

PRESTO

W-Switchable Ceramic Heater Soldering Iron

Tip included



- The boost switch can immediately raise the power from 20 W in normal operation mode to 130 W, which enables the soldering iron to be heated up at a high speed.
- PRESTO can be used for a wide range of applications.
- A safety cap is available for 984 and 985.

When capped



Packing List

980, 981	Unit
984, 985	Unit, Safety cap

Specifications

Model No.	980	981	984	985
Power consumption	20/130 W (while the switch is pushed)			
Heating element	Ceramic heater			
Standard tip	Shape-B (No. 980-T-B)			
Total length*	205 mm	160 mm	205 mm	160 mm
Weight*	48 g	92 g	56 g	100 g

* Without cord and cap

Option

Part No.	Name	Specifications
FH300-81	Iron holder	With cleaning sponge
633-01	Iron holder	With 599B
633-02	Iron holder	With cleaning sponge

* For information on the iron holders, see P.72.

Replacement Tips for PRESTO

Unit: mm

980-T-B Shape-B 	980-T-BC Shape-BC 	980-T-BI Shape-BI 	980-T-D Shape-D
----------------------------	------------------------------	------------------------------	----------------------------

FX-901

Battery-Powered Soldering Iron

Tip included



- Easy-to-carry soldering iron powered by AA alkaline batteries
- Cordless design makes this iron very handy and usable virtually anywhere.



Easy Replacement

Easy tip replacement

Turn the nipple
90° clockwise.



Easy battery replacement



Packing List

FX-901	Unit, Cap
--------	-----------

* Batteries not included

Specifications

Model No.	FX-901
Power supply	AA × 4 pcs
Power consumption	Alkaline batteries: 6 W (6 V) Nickel hydrogen batteries (2150 mAh): 5 W (4.8 V)
Standard tip	Shape-B (No.T11-B)
Battery life*	Alkaline batteries: 60 minutes Nickel hydrogen batteries (2150 mAh): 120 minutes
Total length**	212 mm
Weight***	76 g

Measurement conditions

· When using new batteries, performance will vary depending on the batteries.
· The operating time was measured from the point that the soldering iron was turned on to the point at which the temperature dropped below 300°C, which is the minimum temperature at which soldering can be performed.

* When using batteries other than those specified above, the performance and the operating time will vary.

** Without cap

*** Without battery

Replacement Tips for FX-901

Unit: mm

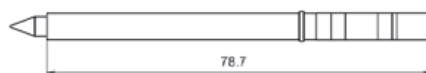

T11-B Shape-B



T11-D4 Shape-4D



RED

Nichrome Heater Soldering Iron

Tip included



- Ideal for use in a variety of soldering works



Specifications

Model No.	500	501	502	503
Power consumption	20 W	30 W	40 W	60 W
Heating element	Nichrome heater			
Standard tip	ø3 x 65 mm (No.BB3)	ø4 x 70 mm (No.BB4)	ø6 x 85 mm (No.BB6)	
Total length*	199 mm	207 mm	248 mm	
Weight*	60 g	65 g	95 g	

* Without cord

Option

Part No.	Name	Specifications
602	Iron holder	With cleaning sponge
603	Iron holder	With cleaning sponge

* For information on the iron holders, see P.72.

MG

Solder Feed Soldering Gun

Tip included



- Solder feed mechanism built in the body allows users to make fine adjustments.



Specifications

Model No.	582	583	585	587	589	592
Power consumption	30 W	40 W	60 W	80 W	100 W	150 W
Heating element	Nichrome heater					
Standard tip	ø4 mm (No.582-T-4)	ø6 mm (No.585-T-6)	ø8 mm (No.587-T-8)	ø10 mm (No.592-T-10)		
Dimensions	197 x 149 mm	213 x 149 mm	227 x 149 mm	241 x 149 mm		
Weight*	266 g	290 g	318 g	322 g	380 g	

* Without cord

Packing List

582, 583, 585, 587, 589, 592	Unit, 1.6 mm diameter Guide nozzle, Instruction manual
-------------------------------------	--

* 2.3 mm diameter guide nozzle is originally set into the unit.

Option

Part No.	Name	Specifications
582-N-0.8	Guide nozzle	0.8 mm
582-N-1.0	Guide nozzle	1 mm
582-N-1.2	Guide nozzle	1.2 mm
607	Iron holder	With cleaning sponge
582-022	Spool holder	-

* For information on the iron holder, see P.72.

FX-301B ESD SAFE

High Performance Soldering Pot **Digital**



- Digital display ensures reliable temperature control and realizes precise temperature adjustment.
- Soldering pot is coated in a special long-life material, which is best suited for lead-free solder. This is provided as a standard feature.

FX-300

High Performance Soldering Pot **Analog**



- Temperature can be adjusted just by turning a knob during operation.
- Adding an optional specially coated stainless-steel pot provides compatibility with lead-free solder.

Quick Heat Up

Time comparison to reach set temperature

FX-301B vs. HAKKO 96 (conventional model)

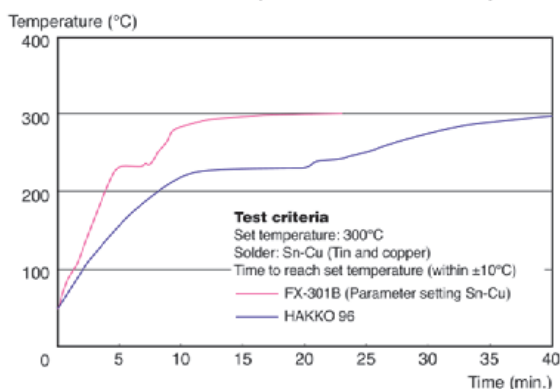

FX-300 vs. HAKKO 96 (conventional model)

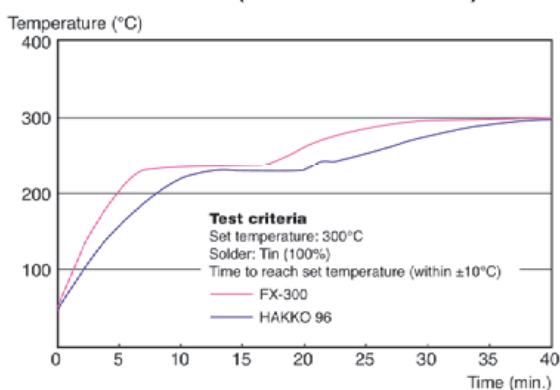

Easy Pot Replacement



Loosen the screw on both sides.



Change the pot and tighten the screws.

* For your safety, be sure to replace the pot after the solder completely cools.

Specially Coated Solder Pot (Durable type)

The special coating prevents the solder pot from corroding, which ensures that the solder pot has a long service life.



Standard solder pot



Specially coated solder pot

Packing List

FX-301B	Unit (with solder pot, 50 × 50 durable type), Spatula, J-shaped waste collector, Hexagon wrench, Instruction manual
FX-300	Unit (with solder pot, 50 × 50), Spatula, J-shaped waste collector, Hexagon wrench, Instruction manual

Specifications

Model No.	FX-301B
Power consumption	200 W (100 V), 260 W (110 V), 290 W (120 V), 240 W (220 V), 260 W (230 V), 280 W (240 V)
Dimensions	143 (W) × 100 (H) × 220 (D) mm
Weight*	1.7 kg

Pot

Temperature range	50 × 50 square: 200 to 450°C 75 × 75 square: 200 to 380°C
Dimensions of solder pot	50 × 50 square durable type: 50 (W) × 42.2 (H) × 50 (D) mm 75 × 75 square durable type: 75 (W) × 51.2 (H) × 75 (D) mm
Molten solder capacity**	50 × 50 square: 0.85 kg 75 × 75 square: 1.2 kg

Model No.	FX-300
Power consumption	195 W (100 V), 220 W (110 V), 200 W (120 V), 190 W (220 V), 205 W (230 V), 215 W (240 V)
Dimensions	143 (W) × 100 (H) × 220 (D) mm
Weight*	1.7 kg

Pot

Temperature range	50 × 50 square: 200 to 450°C 75 × 75 square: 200 to 380°C
Dimensions of solder pot	50 × 50 square standard type: 50 (W) × 42.2 (H) × 50 (D) mm 75 × 75 square standard type: 75 (W) × 51.2 (H) × 75 (D) mm
Molten solder capacity**	50 × 50 square: 0.85 kg 75 × 75 square: 1.2 kg

* Without solder and cord

** The 50 × 50 square solder pot is originally installed. The 75 × 75 square solder pot is an optional part.

Option / Replacements

Part No.	Name	Specifications
A1539	Solder pot	50 × 50 durable type
A1540	Solder pot	75 × 75 durable type
A1517	Solder pot	50 × 50 standard type
A1518	Solder pot	75 × 75 standard type
A1310	Temperature probe	For solder bath and pot

Dimensions of Solder Pot

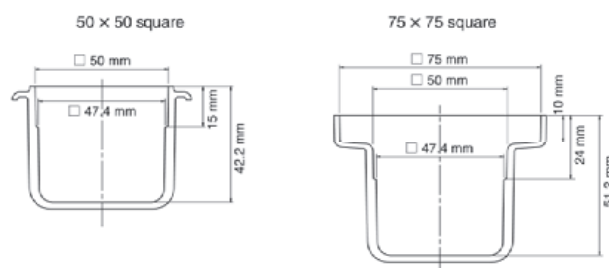

96

Soldering Pot



- Temperature can be adjusted just by turning a knob during operation.

Features

Dimensions of Solder Pot

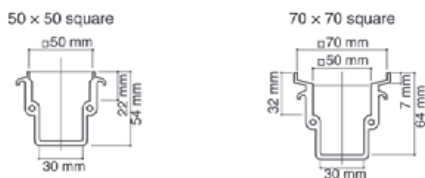

Operation



Packing List

96, 96-1	Unit, Spatula, Instruction manual
----------	-----------------------------------

Specifications

Part No.	96	96-1
Power consumption	200 W	
Dimensions	135 (W) × 105 (H) × 224 (D) mm	135 (W) × 120 (H) × 224 (D) mm
Weight*	1.5 kg	1.6 kg
Temperature range	100 to 450°C	100 to 380°C
Dimensions of solder pot	50 (W) × 54 (H) × 50 (D) mm	70 (W) × 64 (H) × 70 (D) mm
Molten solder capacity	0.85 kg	1.2 kg

* Without cord

485

Flow Soldering System



- Compatible with lead-free solder
- The impeller and chamber, which are the parts that corrode most easily, are plated with corrosion-resistant material.
- Both temperature and time are used to control the solder flow.

Dimensions

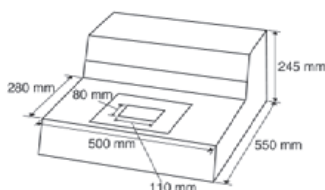

Packing List

485

Main unit, Air unit, Lamp (10 W [6 V]), Horizontal gauge, Spatula, IC tweezers, Waste collector, Positioning board, Foot switch, Locator light, Anti-oxidizer, 42-pin nozzle, 28-pin nozzle, 18/20-pin nozzle, 14/16-pin nozzle, 42-pin air hood, 28-pin air hood, 18/20-pin air hood, 14/16-pin air hood, Instruction manual

* Solder is not included.

Specifications

Model No.	485
Power consumption	850 W
Temperature range	Room temperature to 300°C
Molten solder capacity	10 kg
Dimensions	500 (W) × 245 (H) × 550 (D) mm
Weight*	35 kg

Air unit

Air pressure	196 to 686 kPa (2 to 7 kgf/cm ²)
Dimensions	150 (W) × 100 (H) × 300 (D) mm
Weight**	3.5 kg

* Without solder and cord

** Without cord

375

V-Groove Maker



- Cutting a V-groove put on the solder surface reduces the splash of solder and flux.
- The solder feed amount can be controlled by turning the switch on and off.
- Compact, space-saving automatic solder feeder

Features

Minimize solder and flux splash

Cutting a V-groove on the solder surface enables the release of gas pressure generated by the flux, thereby suppressing splash. HAKKO 375 can cut a groove in only the solder needed, then helps to reduce the level of defectiveness.

Advantages of V-grooved solder

-Examination of solder and flux splash

Test criteria

Measurement method	Measure the amount of solder and flux splashing after solder is fed to the soldering iron
Temperature setting for soldering iron	350°C and 400°C
Solder	Lead-free (Sn-3Ag-0.5Cu) Halogen-free flux ø0.3 mm and ø1 mm
Solder feed length	50 mm

* The effect of solder and flux splashing prevention may differ under different operation conditions.

Solder cross-section view

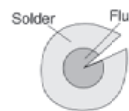

3D view

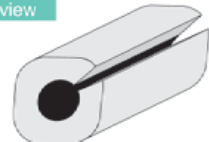

V-grooved solder

Amount of flux splashing (quantity of dots)

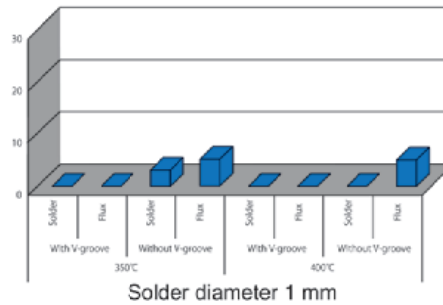
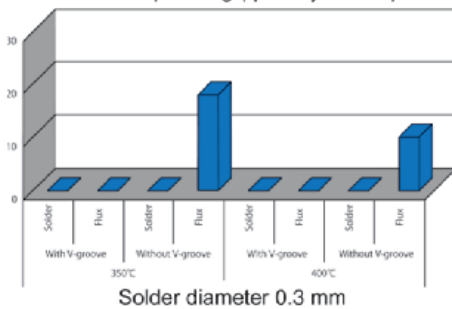

Packing List

375	Unit, AC Adapter, Instruction manual
-----	--------------------------------------

Option

Part No.	Name
B1649	Foot switch
B2763	Hand switch

Specifications

Model No.	375
Rating	DC 24 V 75 mA
Solder feed speed	27 mm/sec.
Usable solder diameter	ø0.3, 0.5, 0.6, 0.8, 1 mm
Dimensions	78 (W) × 98 (H) × 56 (D) mm
Weight	0.59 kg

AC Adapter

Output voltage	DC 24 V
----------------	---------

373 ESD SAFE

Self Feeder



- Automatic solder feeder that enables a user to complete soldering work with just one hand
- The solder feed time and speed can be set.

Set-Up Example

•Soldering for one-handed operation

Soldering irons + HAKKO 373 + Solder diameter adjustment ring + Tube unit with switch or Guide pipe assembly

* See the applicable soldering irons in the P.63.

Set-up example

•Soldering with a feeder pen

Soldering irons + HAKKO 373 + Solder diameter adjustment ring + Feeder pen + Switch

* Compatible with all soldering irons

Set-up example

Foot switch or Feeder switch

Specifications

Model No.	373
Power consumption	6 W
Solder feed time	0 to 7 sec. (auto mode)
Solder feed speed	4.5 to 26 mm/sec.
Solder feed quantity	0 to 182 mm
Solder return quantity	0 to 5 mm (fixed speed)
Mode	Auto and manual
Usable solder diameter*	ø0.6, 0.65, 0.8, 1, 1.2, 1.6 mm
Usable solder quantity	1 kg or less
Dimensions	107 (W) × 110 (H) × 215 (D) mm
Weight**	1.5 kg

* ø1.6 mm lead free solder can't be used.
**With cord







Packing List

373	Unit, Instruction manual
-----	--------------------------

The accessories that are required for initial set-up, such as a tube unit, guide pipe assembly, and solder diameter adjustment ring, are not included. They must be ordered separately and adapted to use with the soldering iron and solder wire diameter.

Accessory Selection Guide

■ One-handed operation

Applicable soldering iron	Solder feed unit	Solder diameter	Options		
			Solder diameter adjustment ring	Guide pipe assembly	Tube unit
FM-2027 FM-2028 	373	0.6, 0.65 mm	B1626	B3481	B3477
		0.8 mm	B1627	B3482	
		1 mm	B1628	B3483	
		1.2 mm	B1629	B3484	B3478
FM-2030 FN-1101 	373	0.6, 0.65 mm	B1626	B3726	B3477
		0.8 mm	B1627	B3727	
		1 mm	B1628	B3728	
		1.2 mm	B1629	B3729	B3478
FX-1001  <small>* The spacer No.B5183 is required separately.</small>	373	0.6, 0.65mm	B1626	B3481	B3477
		0.8mm	B1627	B3482	
		1mm	B1628	B3483	
		1.2mm	B1629	B3484	B3478
FX-8002 	373	0.6, 0.65mm	B1626	B5072	B3477
		0.8mm	B1627	B5073	
		1mm	B1628	B5074	
		1.2mm	B1629	B5075	B3478
FX-8301 	373	0.6, 0.65 mm	B1626	B3566	B3563
		0.8 mm	B1627	B3567	
		1 mm	B1628	B3568	
		1.2 mm	B1629	B3569	B3564
		1.6 mm	B1630	B3570	
FX-8801 	373	0.6, 0.65 mm	B1626	B2146	B2143
		0.8 mm	B1627	B2147	
		1 mm	B1628	B2148	
		1.2 mm	B1629	B2149	B2144
		1.6 mm	B1630	B2150	
FX-8805 	373	0.6, 0.65 mm	B1626	B2151	B2143
		0.8 mm	B1627	B2152	
		1 mm	B1628	B2153	
		1.2 mm	B1629	B2154	B2144
		1.6 mm	B1630	B2155	

■ Feeder pen

Applicable soldering iron	Solder feed unit	Solder diameter	Options		
			Solder diameter adjustment ring	Feeder pen	Switch
Compatible with all soldering irons	373	0.6, 0.65 mm	B1626	C1234	B2124 feeder switch or B1649 foot switch
		0.8 mm	B1627		
		1 mm	B1628		
		1.2 mm	B1629		
		1.6 mm	B1630	C1235	

FT-802 ESD SAFE New

Thermal Wire Stripper

Blade not included



- Thermal wire stripper for higher quality and more preciseness

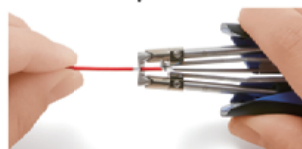

- It can strip insulation with no nick.
- Even very fine AWG 38 can be stripped with standard blades.
- Space saving by the integration of station and holder



Connectable with handpiece for knife type blade

Knife type blade can strip the insulation of big cable with no nick.

FT-8003 ESD SAFE

Handpiece for knife type blade

Blade included



Specifications

Model No.	FT-802
Power consumption	76 W

Station

Output voltage	AC 20 V
Dimensions	76 (W) × 159 (H) × 161 (D) mm
Weight	1.6 kg

Handpiece

Power consumption	72 W (20 V)
Cord length	1.6 m
Total length	153 mm
Weight*	47 g

* Without cord and blade

Model No.	FT-8003
Power consumption	46 W (24 V)
Tip to ground resistance	<2 Ω
Tip to ground potential	<2 mV
Cord length	1.3 m
Total length	155 mm
Weight*	27 g

* Without cord and blade

Packing List

FT-802	Station (with wire material indicator seal), Handpiece with lead adjuster (FT-8004), Hexagon socket set screw (M2.5 × 2.5 [qty 2]), Hexagon wrench (1.27 mm), Power cord, Instruction manual
FT-8003 (Conversion kit)	Handpiece (FT-8003), Knife blade, Handpiece holder, Blade removal tool, Connecting cable, Instruction manual

Features

Thermal strip gives great sharpness.

FT-802



FT-802 can strip the insulation of AWG 38 wire with no nick.

Conventional wire stripper

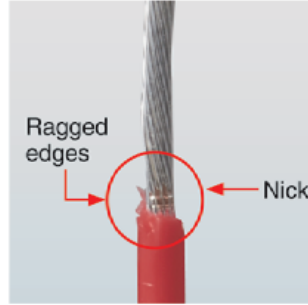

Conventional wire stripper could make ragged edges of insulation or damage strands.

Due to the tweezers structure, the cutting edges are always aligned.

The blades can be securely fixed by making the frame with tweezers structure.

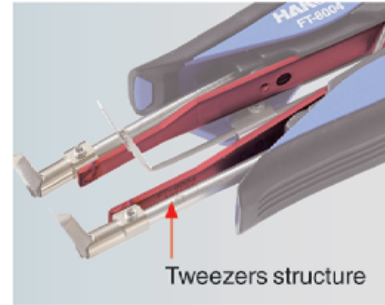

Output setting by the unit of 5%

Easy to set optimum output level as per material



Material	Output value (%)
PVC	10
PE	10
PA	20
PVDF	30
ETFE	40
SI	45
PTFE	55

* The above values are for reference.

Blades are replaceable and a handpiece can be saved.

No need to replace a handpiece when blades get worn out. Blades can be easily replaced by using the hex-wrench (included in the unit) and the blade removal plate.

* The blades must be cool before replacement for safety.



Remove blades.

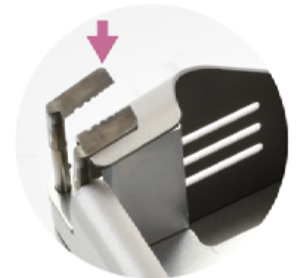

Put removed blades in the holder.

User-friendly display

Status of a handpiece at glance on the display.

User-friendly design for reduction of stress during the work.



- A handpiece is correctly set in a holder.
- Same as the output value.
- Ready to work immediately.
- Auto sleep function will activate after passing the set time.

Optional Blades

For FT-8004

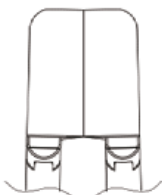

G4-1601

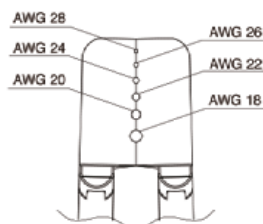

G4-1602

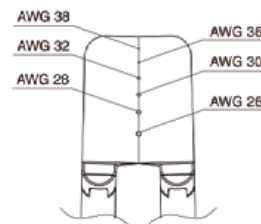

G4-1603

For FT-8003 (option)

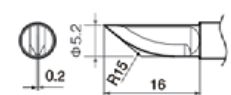

G3-1601

HAND TOOLS New

Cutting pliers, pliers and tweezers



- Pliers are recommended to cut or process annealed copper wires for electronic parts and excellent sharpness and durability due to our unique heat-treatment
- Non-magnetic stainless-steel tweezers for electronic parts

Full flush cut to make cut surface extremely flat

Micro cutting pliers

Narrow cutting blades for tight spaces

Cutting pliers

Excellent wearing resistance and durability

Long needle nose pliers

Needle nose eases a work in tight spaces

Pliers

Great usability
Perfect to grasp and bend

Wires can be cut even at the lowest position of blades near to the joint.

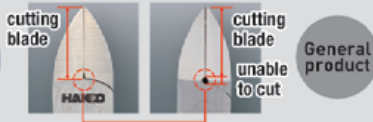

FT-600



FT-601



FT-620



FT-621



Specifications

Part No.	FT600-81			FT601-81		
Cutting capacity	ø1.2mm (max.)			ø1.5mm (max.)		
Dimensions (mm)	A	B	C	A	B	C
	117	50	11	117	51	15.5
	D	E	F	D	E	F
	6	21	13.4	8.5	24	16.8

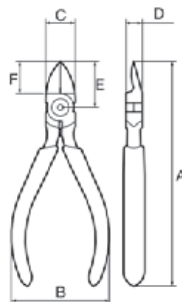

Specifications

Part No.	FT620-81			FT621-81		
Dimensions (mm)	A	B	C	A	B	C
	148	50	11	124	50	11
	D	E	F	D	E	F
	6	60	52.4	6	36	28.4

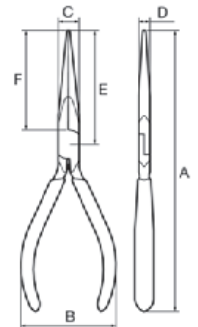

Precision tweezers / straight

Precision tweezers / bent



FT-640



FT-641

Specifications

Part No.	FT640-81		FT641-81	
Dimensions (mm)	A	B	A	B
	113	9	118	10



CUTTING TOOL

Cutting pliers, pliers



- Wire cutters/needle-nose pliers designed for general-purpose work
- Use in cutting copper and soft lead wires (do not use on hard drawn steel wires.)

MAX.Cu = Max. annealed copper lead wire cutting capability

Cutting tool for flush cut with safety clip



Part No. 106-01

Cutting tool for flush cut with angled blade



Part No. 106-02

Cutting tool for flush cut with small blade



Part No. 106-03

Cutting tool for a front, flush cut



Part No. 106-04

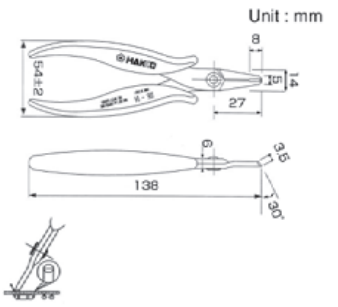
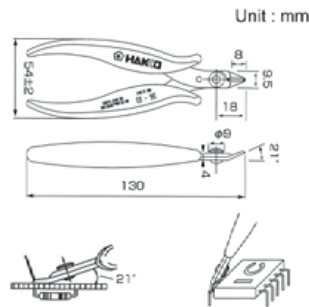
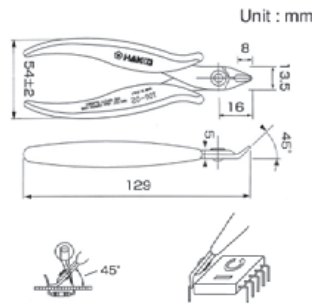
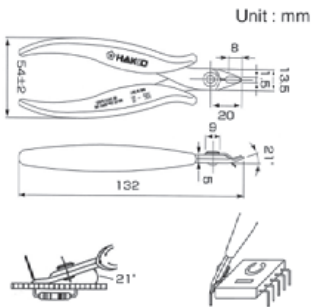

Cutting tool for flush cut



Part No. 106-05

Short nose pliers

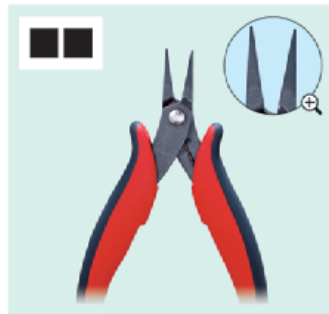

Part No. 106-06

Long nose pliers

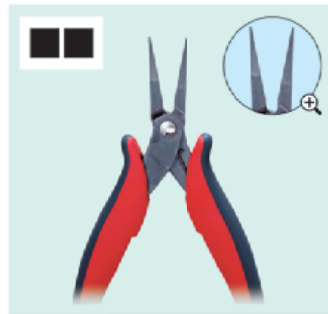

Part No. 106-07

Bent nose pliers

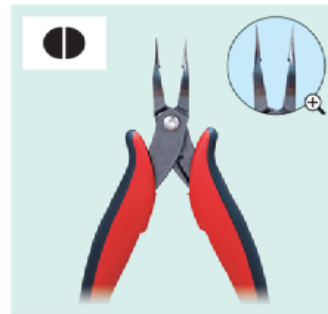

Part No. 106-08

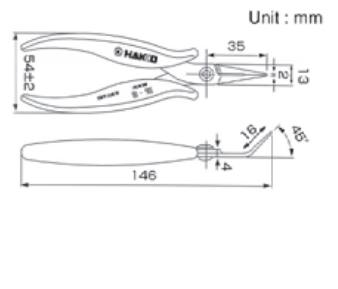
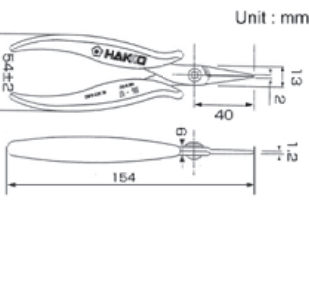
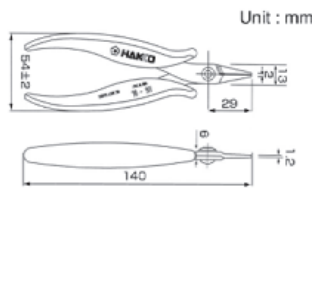
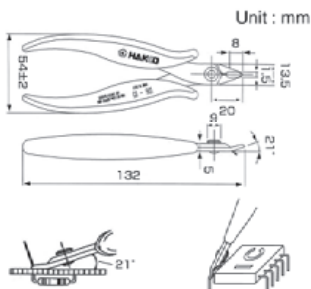

153 / 154

Lead Cutter and Former

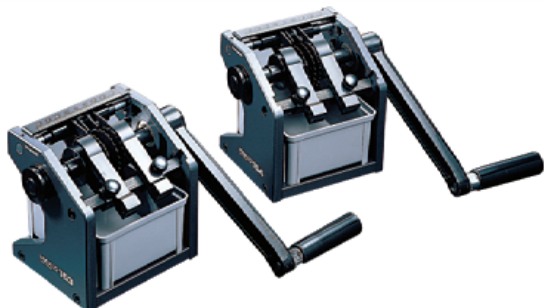

- Lead cutter and former for axial components
- Can be used for forming and cutting, forming only, or cutting only

Cutting and Forming

HAKKO 153	HAKKO 154
<p>Cutting and forming</p>	<p>Cutting and forming</p>
<p>Forming</p>	<p>Forming</p>
<p>Cutting</p>	<p>Cutting</p>

Packing List

153, 154

Unit, Parts tray, Clamp, Handle, 2 mm Hexagon wrench, 2.5 mm Hexagon wrench, 3 mm Hexagon wrench, 4 mm Hexagon wrench, Instruction manual

Specifications

Part No.	153-1	154-1
Forming size	5.6 mm pitch	5 mm pitch
Diameter of lead wire	ø0.8 mm (max.)	ø0.5 mm (max.)
Lead wire*	For annealed copper lead wire only	
Outer width of tape	85 mm (max.)	
Taping pitch	5 mm	
Dimensions	125 (W) × 130 (H) × 110 (D) mm	
Weight**	2 kg	

* These tools are not suited to work on components with lead frames (square lead).
** Including handle and clamp

155

Lead Cutter



- Lead cutter for radial components

Cutting

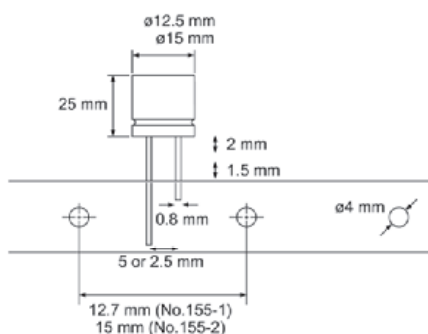

* Cutting only

Packing List

155

Unit, Parts tray, Clamp, Handle, 2 mm Hexagon wrench, 2.5 mm Hexagon wrench, 3 mm Hexagon wrench, 4 mm Hexagon wrench, Instruction manual

Specifications

Part No.	155-1	155-2
Diameter of lead wire	ø0.8 mm (max.)	
Lead wire*	For annealed copper lead wire only	
Processing part size	ø12.5 × 25 mm (max.)	ø15 × 25 mm (max.)
Feed hole pitch	12.7 mm	15 mm
Lead pitch**	5 mm, 2.5 mm	5 mm
Processing size	1.5 mm from taping end, 2 mm from component end (min.)	
Dimensions	110 (W) × 140(H) × 125 (D) mm	
Weight**	1.7 kg	

* These tools are not suited to work on components with lead frames (square lead).
** When shipped, the unit is set for components with a lead pitch of 5 mm.
*** Including handle and clamp

152B

Motor Drive



Lead cutter or former is not included in HAKKO 152B.

Packing List

152B	Unit, Instruction manual
------	--------------------------



- Motor drive that enables automatic cutting and forming of taped components
- Constant-torque drive ensures precise and speedy processing.
- Speed control knob enables the adjustment of the processing speed.

Specifications

Model No.	152B
Power consumption	30 W
Processing capacity (with HAKKO 153, 154)	50 Hz : 30,000 pcs/hr (max.) 60 Hz : 36,000 pcs/hr (max.)
Processing capacity (with HAKKO 155)	50 Hz : 15,000 pcs/hr (max.) 60 Hz : 18,000 pcs/hr (max.)
Dimensions	430 (W) × 140 (H) × 150 (D) mm
Weight*	5.6 kg

* Without cord

DIPLINER

Lead Straightener

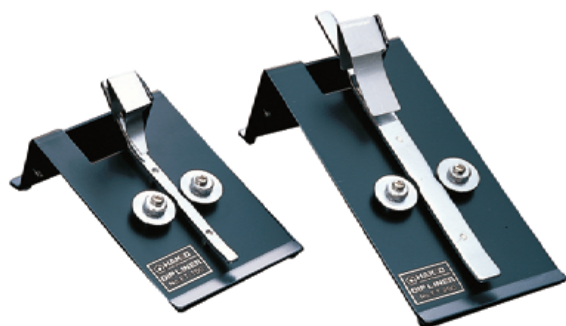

- IC lead liner for correcting variable lead pitches
- Simple mechanism enables the adjustments with just one screw.
- Simply insert the IC case into the chute.

Packing List

FT100, FT150, FT200, FT300	Unit, Instruction manual
----------------------------	--------------------------

Specifications

Part No.	FT100	FT150	FT200	FT300
Width of IC	7.5 mm	10 mm	15 mm	19 mm
Number of IC leads	8, 14, 16 18, 20	22	24, 28 40, 42	64

FT-710 ESD SAFE

Solder-Splash-Preventing Rotary Tip Cleaner





- The solder removal level can be adjusted using two different types of brushes.
- Brushes can be replaced without using any tools, and safe design prevents solder waste from entering the drive part.

Features

Solder-Splash prevention

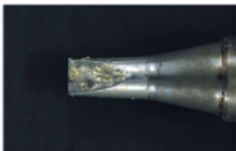
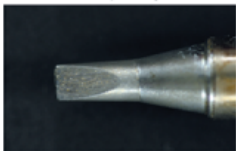

Controllable solder removal level

Brush	Cleaning brush A (standard accessory)	Cleaning brush B (optional)
Material	Resin 	Metal 
Image after cleaning	Some solder remains. 	Solder is completely removed. 
Benefit	Prevents tip oxidation and extends the service life of the tip	Suitable for soldering small sections that require control over the amount of solder.

Minimizes decrease in temperature of the tip during cleaning

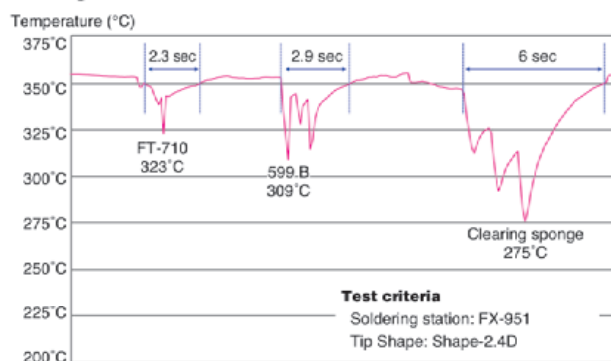

Packing List

FT-710	Unit, AC adapter, Receptacle A, Receptacle B, Lock nut, Gauge, Instruction manual
--------	---

Specifications

Model No.	FT-710
Rating	DC 24 V 130 mA
Brush rotational speed	2500 rpm
Standard receptacle	Receptacle A and B
Dimensions	71 (W) × 77 (H) × 107 (D) mm
Weight	450 g

AC adapter

Output voltage	DC 24 V
----------------	---------

Compatibility table

Tip	Receptacle A	Receptacle B	Receptacle C
T12, T11, T36	✓		
T18		✓	
T20, T13, T22			✓

* This cleaner cannot be used with T12-JL02, quad type, tunnel type, and spatula type soldering tips of T12 series.

* It can be used with T19 series, only with the use of a custom-ordered receptacle. In this situation, consult your nearest HAKKO dealer or distributor.

* It cannot be used with FX-8802 and FX-8803 with T18 series.

* There are some tips with dimensions that cannot be adjusted with the standard receptacles. In this situation, consult your nearest HAKKO dealer or distributor.

Option

Part No.	Name	Specifications
A1567	Cleaning brush B	Metal brushes, set of 2
B3519	Receptacle C	—

FT-700

Tip Polisher



- Soldering tip polisher best suited to the removal of carbide and oxide on soldering tips
- Prevents the shortening of the service life of tips caused by oxidation

Usage

Cleaning procedure



Use the brush to remove tough oxide.

FS-100

Chemical Paste



- Chemical paste best suited to the removal of oxide on soldering iron tips
- Also used for re-tinning of soldering tips

Packing List

FS-100	Paste, Instruction manual
--------	---------------------------

Specifications

Chemical paste

Amount	10 g
Ingredients	Flux, tin (Sn) 50 wt% (each)

- * The flux component of chemical paste consists of alicyclic amine hydrobromate, aliphatic amine hydrobromate, petrolatum, and wax.
- * Make sure the tip is cleaned after use according to the procedure shown above.
- * Do not use the chemical paste for purpose other than restoring of the soldering tip.

IRON HOLDER

Iron Holder



No. FH300-81*



No. 633-01



No. 633-02



No. 607



No. 602



No. 603

* HAKKO 599B can be also mounted.

Wire-type tip cleaner



No. 599B



HAKKO 599B

Prevents soldering tip oxidation

Applicable Soldering Irons

Part No.	FH300-81	633-01	633-02	607	602	603
Soldering irons	DASH PRESTO FX-600 FX-601	DASH PRESTO FX-600 FX-601	DASH PRESTO FX-600 FX-601	MG	RED	RED

611 ESD SAFE

Reel Stand



No. 611-2



- Solder reel stand for coiled solder with a maximum load of 1 kg
- Smooth action when reeling out solder wire improves work efficiency
- A mounting screw for the grounding wire is attached on the baseplate.

Specifications

Part No.	611-1	611-2
Shaft diameter	ø15 mm	
Usable solder	Roll solder 1 kg (max.) × 1	Roll solder 1 kg (max.) × 2
Dimensions	87 (W) × 78 (H) × 141 (D) mm	87 (W) × 200 (H) × 141 (D) mm
Weight	450 g	750 g

FS-210

Brush-tip Type Flux Pen



- Pen tip does not split easily.
- You can fill your favorite flux into FS-210.
- Simply push the pen shaft when you need some extra flux.

Features

Pen for pinpoint application of optimum amount of flux

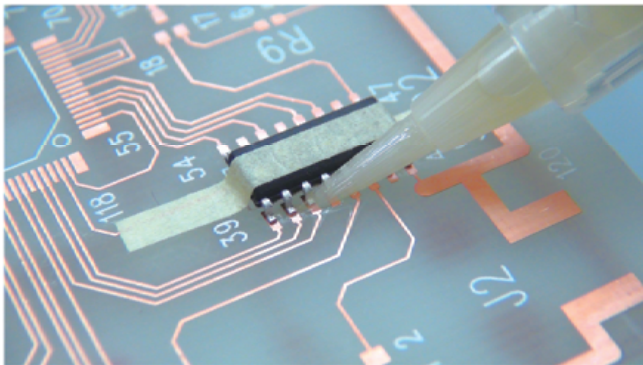

Simply push the shaft for a generous coating of flux



Packing List

FS210-82	Flux container for 4 mL (5 pcs)
----------	---------------------------------

* No flux contained.

Replacement Parts

A5009	Brush-tip with a cap (5 pcs)
-------	------------------------------

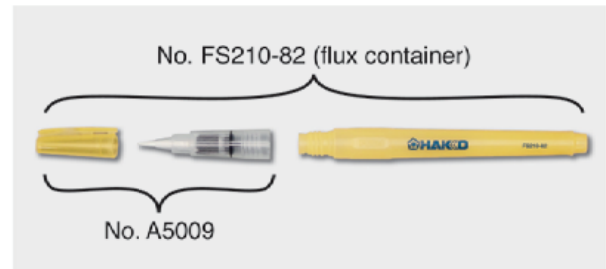

392 ESD SAFE

Outlet-Powered Type



- Outlet-powered suction pick-up tool with built-in vacuum pump
- The pick-up capacity can be increased up to 230 gf with an optional pad.

393

Dropper Type



- Portable, easy-to-carry manual dropper-type vacuum pick-up
- Maximum pick-up capacity of 40 gf
- Uses antistatic material

394

Battery-Powered Type



- Battery-powered suction pick-up tool with built-in vacuum pump
- Maximum pick-up capacity of 120 gf
- Uses antistatic material

Usage Example

HAKKO 392



HAKKO 393

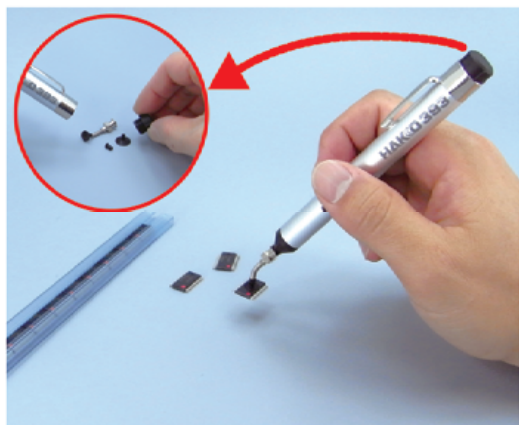

HAKKO 394



With the bent nozzle accessory, 0603-size components can be picked up.



Replacement Pads and Nozzles

Part No.	Name	Specifications
A1164	Bent nozzle	0.4 mm
A1165	Bent nozzle	1.1 mm with stopper
A1198	Bent nozzle	0.26 mm
A1486	Straight nozzle	1.1 mm with stopper
A1166	Pad	3 mm
A1312	Pad	5 mm
A1167	Pad	7 mm
A1311	Pad	10 mm

Packing List

392	Unit, ø0.4 mm bent nozzle, ø1.1 mm bent nozzle, ø3 mm pad, ø7 mm pad, Instruction manual
393	Unit, ø1.1 mm bent nozzle with stopper, ø3 mm pad, ø7 mm pad, ø10 mm pad, Instruction manual
394	Unit, ø1.1 mm bent nozzle with stopper, ø5 mm pad, ø10 mm pad, Two AAA Alkaline batteries (for trial), Instruction manual

Specifications

Model No.	392
Power consumption	5 W
Maximum pressure	37.3 kPa (280 mmHg)
Pad	Conductive silicone rubber
Dimensions	Station: 132 (W) × 83 (H) × 170 (D) mm Pen: ø10 × 123 (L) mm Hose: 1.1 m
Weight*	Station: 1.65 kg Pen: 25 g

* Without cord, nozzle and pad

Model No.	393
Pad	Conductive silicone rubber
Dimensions	ø13 mm × 132 mm
Weight*	19 g

* Without nozzle and pad

Model No.	394
Power supply	Two AAA batteries
Pad	Conductive silicone rubber
Battery life	Approx. 30,000 suction cycles (with alkaline batteries)
Suction capacity	120 gf (with a pad diameter of 10 mm)
Dimensions	130 (W) × 29 (H) × 22 (D) mm
Weight*	43 g

* Without batteries, nozzle and pad

FR-301

Nozzle quick change type

Portable Desoldering Tool

Nozzle included



- Power switch and adjustable temperature control built in the handle
- Use of high thermal efficiency N61 series nozzles
- Reduction of solder clogging by improved heating core (in comparison with the previous model)

Packing List

FR-301	Unit, Pre-filter, Ceramic paper filter (L, qty 2), Nozzle wrench, Iron holder (simple type), Cleaning pin for heating core, Cleaning pin for $\phi 1$ mm nozzle, Instruction manual
--------	---



Provided in a carrying case

Specifications

Model No.	FR-301
Power consumption	100 V 98 W (50/60 Hz) 110 V 122 W (50/60 Hz) 120 V 140 W (60 Hz) 220 V 100 W (50/60 Hz) 230 V 110 W (50/60 Hz) 240 V 120 W (50/60 Hz)
Temperature range	350 to 500 °C
Nozzle to ground resistance	<2 Ω
Nozzle to ground potential	<2 mV
Vacuum generator	Diaphragm pump
Vacuum pressure	81 kPa (610 mmHg)
Suction flow	11 L/min.
Heating element	Ceramic heater
Standard nozzle	$\phi 1$ mm (No.N61-08)
Dimensions	215 (W) \times 226 (H) mm (with $\phi 1$ mm (No.N61-08) nozzle)
Weight*	0.52 kg (with $\phi 1$ mm (No.N61-08) nozzle)

* Without cord

Features

Easy temperature control

LED indicators let you easily see when the heater is active and idling at your temperature setting.

- Temperature range
- Setting 1 350°C
 - Setting 2 400°C
 - Setting 3 450°C
 - Setting 4 500°C



A wide selection of nozzles (N61 series)

SS type nozzles for micro land patterns



Oval shape nozzles for flat terminals



Long type nozzles for narrow space



Quick-change nozzle replacement with special tools

- Provided nozzle wrench



- Optional accessory Nozzle quick changer

Quick and safe nozzle replacement with nozzle quick changer
 * It can't be used for the previous model (FR-300).

Nozzle quick changer for FR-301: part No. C5046

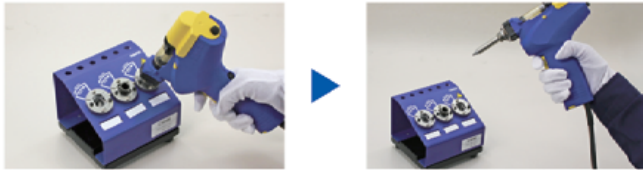

* The positioning jig (No. B5231) is separately required for oval type nozzle.

Reduction of solder clogging by improved heating core

This additional guard prevents a temperature drop of the heating core by making contact with the front holder and it enables to reduce solder clogging.

* In comparison with the previous model

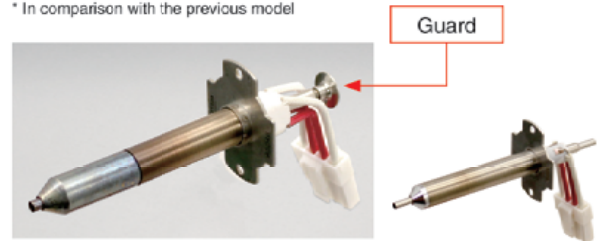

Heating core of the previous product (FR-300)

Replacement Nozzles

Unit : mm

SS type	N61-01	N61-02	N61-03	
S type	N61-04	N61-05	N61-06	
Standard type	N61-07	N61-08	N61-09	N61-10
Long type	N61-11	N61-12	N61-13	N61-14
Oval type	N61-15	N61-16		

* N61 series nozzles can also be used for FR-410 desoldering station.

FR-400

ESD SAFE

Nozzle quick change type

 GOOD DESIGN

Heavy Duty Desoldering Tool **Digital**

Nozzle included

Power Consumption
300 W



- 300 W heavy duty desoldering tool with built-in vacuum pump
- Secure desoldering with valve function
- Reduction of solder clogging
- Improvement in maintainability

FR-410

ESD SAFE

Nozzle quick change type

High-Power Desoldering Tool **Digital**

Nozzle included

Power Consumption
140 W



- 140 W high power enables perfect desoldering for the components on multi-layer P.W.B.
- A wide selection of nozzles is available for a variety of desoldering works.

Feature of FR-400

300 W tremendous power makes incredible heating.

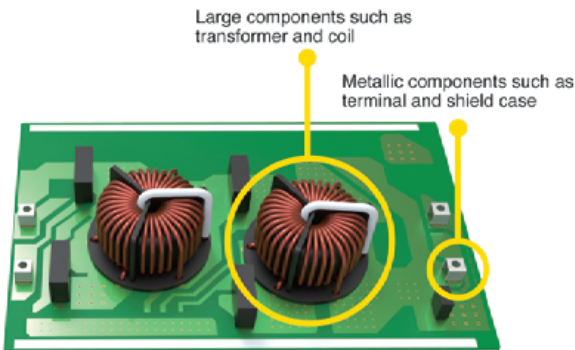

Feature of FR-410

A wide selection of nozzles is available for a variety of desoldering works.

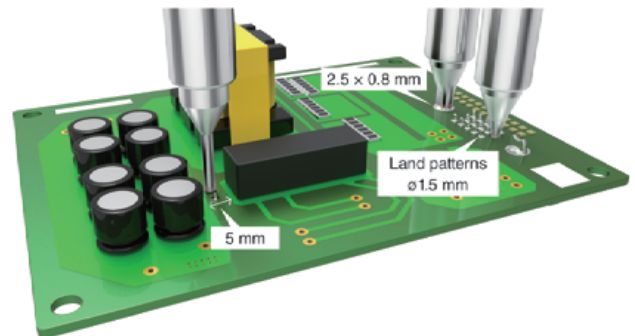

Common Features of FR-400 and FR-410

Secure desoldering, valve function that suctions with high pressure

Suction starts 0.2 seconds after pulling the trigger for instance and high pressure suction to achieve complete desoldering.

Improvement in heating core

Heating ability for backside of heating core is increased to ensure suctioned solder be carried to filter pipe and avoid solder clogging.

Featuring ACF (Anti Clogging Function)

ACF ensures suctioned solder be carried to filter pipe by keeping pump running for a second after releasing trigger.

Reduction of solder clogging by improved heating core

The additional guard prevents a temperature drop of the heating core by making contact with the front holder and it enables to reduce solder clogging.

* In comparison with the previous model

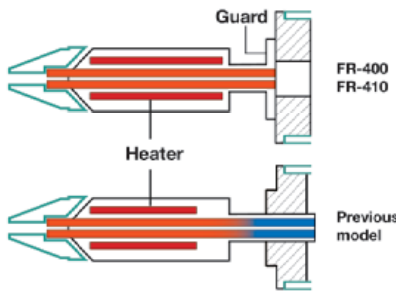

Improvement in maintainability

■ Easy heater replacement

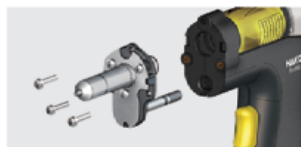

By removing 3 screws

■ Tool box for maintenance kit



■ Quick change nozzle replacement with optional accessory

Quick and safe nozzle replacement with nozzle quick changer
* It can't be used for previous desoldering tools (FR-4001 or FR-4101).

Nozzle quick changer for FR-4003: Part No. C5045
Nozzle quick changer for FR-4103: Part No. C5046



* The positioning jig below is separately required for oval type nozzle.
Oval nozzle positioning jig: part No.B5229 for FR-4003
part No.B5230 for FR-4103

Packing List

FR-400	Station, Desoldering tool (FR-4003), Power cord, Iron holder (with cleaning wire), Tool box (Cleaning pin for ø1 mm, Cleaning pin for heating element, Cleaning drill for ø1 mm, Nozzle wrench, Filter [qty 2], Ceramic paper filter [qty 4]), Instruction manual
FR-410	Station, Desoldering tool (FR-4103), Power cord, Iron holder (with cleaning wire), Tool box (Cleaning pin for ø1 mm, Cleaning pin for heating element, Cleaning drill for ø1 mm, Nozzle wrench, Filter [qty 2], Ceramic paper filter L [qty 4]), Instruction manual

Specifications

Model No.	FR-400	FR-410
Power consumption	320 W	190 W
Temperature range	350 to 500 °C	330 to 450 °C
Temperature stability	±5 °C at idle temperature	±5 °C at idle temperature

Station

	FR-400	FR-410
Output voltage	AC 29 V	AC 24 V
Vacuum generator	Vacuum pump, double cylinder type	Vacuum pump, double cylinder type
Vacuum pressure	80 kPa (600 mmHg, max.)	80 kPa (600 mmHg, max.)
Suction flow*	15 L / min.	15 L / min.
Dimensions	166 (W) × 137 (H) × 264 (D) mm	165 (W) × 137 (H) × 244 (D) mm
Weight	5.7 kg	4.8 kg

Desoldering Tool

	FR-400	FR-410
Power consumption	300 W (29 V)	140 W (24 V)
Nozzle to ground resistance	<2 Ω	<2 Ω
Nozzle to ground potential	<2 mV	<2 mV
Heating element	Composite heater	Composite heater
Standard nozzle	ø1 mm (No. N60-02)	ø1 mm S type (No. N61-05)
Cord length	1.2 m	1.2 m
Total length**	183 mm (with ø1 mm nozzle)	168 mm (with ø1 mm S type nozzle)
Weight**	270 g (with ø1 mm nozzle)	190 g (with ø1 mm S type nozzle)

* The suction flow is measured at the filter case suction port of station.

** Without cord and hose

Desoldering Tool

Replacement Nozzles for FR-400

Unit : mm

N60-01 Nozzle $\phi 0.8$ 	N60-02 Nozzle $\phi 1$ 	N60-03 Nozzle $\phi 1.3$ 	N60-04 Nozzle $\phi 1.6$ 	N60-05 Nozzle $\phi 2$
N60-06 Nozzle $\phi 2.6$ 	N60-07 Nozzle $\phi 3$ 	N60-08 Nozzle 4.2 x 1.5 	N60-09 Nozzle 6.2 x 1.5 	

Replacement Nozzles for FR-410

Unit : mm

SS type N61-01 	N61-02 	N61-03 		
S type N61-04 	N61-05 	N61-06 		
Standard type N61-07 	N61-08 	N61-09 	N61-10 	
Long type N61-11 	N61-12 	N61-13 	N61-14 	
Oval type N61-15 	N61-16 	<p>* N61 series nozzles can also be used for FR-301 desoldering tool.</p>		

FM-204 ESD SAFE

Composite-type Desoldering Tool Digital

Nozzle not included



- Vacuum pump built-in type desoldering tool
- Digital display ensures easy and reliable temperature control.
- Sleep function that works with iron holder prevents nozzle oxidation.

Packing List

FM-204	Station, Iron holder, Ceramic paper filter (10 pcs), Cleaning drill for heating element, Filter pipe assembly (1 pc), Control card, Power cord, Connecting cable, Nozzle remover, Desoldering tool (FM-2024), Handle for gun configuration, Instruction manual
--------	--

Features

Replacing the handpiece enables soldering.

- Soldering
 ■ N₂ System (P.46 & P.47)



Specifications

Model No.	FM-204
Power consumption	120 W
Temperature range	FM-2024: 350 to 450°C FM-2026/2027: 200 to 450°C
Temperature stability	±5°C at idle temperature

Station

Output voltage	AC 24 V
Vacuum generator	Vacuum pump, double cylinder type
Vacuum pressure	80 kPa (600 mmHg, max.)
Suction flow*	15 L/min.
Dimensions	160 (W) × 120 (H) × 225 (D) mm
Weight	3.7 kg

Desoldering Tool

Power consumption	70 W (24 V)
Nozzle to ground resistance	<2 Ω
Nozzle to ground potential	<2 mV
Heating element	Composite heater
Cord length	1.2 m
Total length**	180 mm (with ø1 mm nozzle)
Weight**	65 g (with ø1 mm nozzle)

* Measured at the filter case suction port of the station.

** Without cord and hose

Optional Nozzles for FM-204

Unit : mm

N1-06 Nozzle ø0.6 	N1-08 Nozzle ø0.8 	N1-10 Nozzle ø1 	N1-13 Nozzle ø1.3
N1-16 Nozzle ø1.6 	N1-20 Nozzle ø2 	N1-23 Nozzle ø2.3 	N1-L10 Nozzle ø1 long

SPPON

Desoldering Tool

Nozzle included



- Light-weight and simplified desoldering tool with high suction power
- Use a cleaning shaft that enables the nozzle to be cleaned after each use
- Nozzles can be easily replaced.

Replacement Nozzles

Unit : mm

Part No.	Figure	Adaptation products
18-N		No. 18, 18G
20-N		No. 20, 20G
DS01-N		No. DS01P

Specifications

Part No.	Absorption capacity
18	12 cm ³ (12 cc)
18G	12 cm ³ (12 cc) with guard
20	20 cm ³ (20 cc)
20G	20 cm ³ (20 cc) with guard
DS01P	28 cm ³ (28 cc)

WICK

Desoldering Wire



- Economical and easy-to-use desoldering wire

Features

Through-hole solder removal

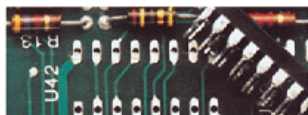
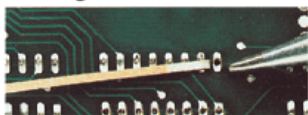

Bridging solder removal



Specifications

No clean type (halogen free, ESD SAFE package)

Part No.	Description
FR150-81	1.5 m × 0.7 mm
FR150-82	1.5 m × 1 mm
FR150-83	1.5 m × 1.5 mm
FR150-84	1.5 m × 2 mm
FR150-85	1.5 m × 2.5 mm
FR150-86	1.5 m × 3 mm

Unflux type (unflux)

Part No.	Description
FR110-00	1.5 m × 0.6 mm
FR110-02	1.5 m × 1.4 mm
FR110-03	1.5 m × 1.9 mm
FR110-04	1.5 m × 2.5 mm
FR110-05	1.5 m × 3.3 mm

851 ESD SAFE

Hot-Air SMD Rework Station Analog

Nozzle included



- Single-nozzle hot air rework system that is perfect for the repair or local heating of small surface-mounted components
- Slim grip is ideal for work in narrow spaces.

Temperature Distribution Chart

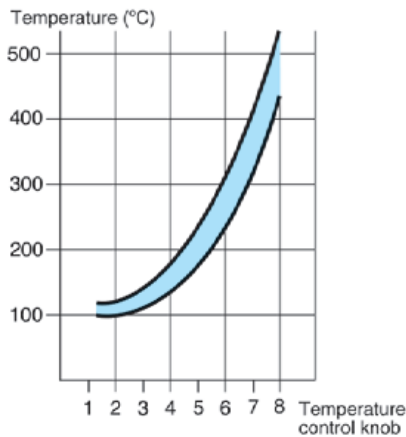

Test criteria

Measured at a point	2 mm from the nozzle
Room temperature	20 °C
Nozzle used	A1066 ø2 mm

Replacement Nozzles

Part No.	Name	Specifications
A1065	Nozzle	ø1.5 mm
A1066	Nozzle	ø2 mm
A1067	Nozzle	ø3 mm
A1147	Nozzle	ø1 mm

Packing List

851	Station with handpiece, Handpiece holder, Nozzle holder, Instruction manual
-----	---

Specifications

Model No.	851
Power consumption	85 W
Hot air temperature	100 to 540°C

Station

Power consumption	5 W
Air flow	6 L/min. (max.)
Dimensions*	167 (W) × 101 (H) × 182 (D) mm
Weight*	1.8 kg

Handpiece

Power consumption	80 W
Standard nozzle	ø2 mm (No. A1066)
Total length**	217 mm
Weight**	180 g

* Without cord and handpiece

** Without cord

FR-810B ESD SAFE

Hot-Air SMD Rework Station **Digital**

Nozzle included



- High volume airflow and high output for a various kinds of rework
- Full digital control of temperature, airflow, and time
- Simple nozzle removal and easy maintenance
- The vacuum pick-up function with an indicator ensures safety for the components and P.W.B.

FR-811 ESD SAFE

Hot-Air SMD Rework Station **Digital**

Nozzle not included



- Possible to make full-scale thermal profiles with 6-zone hot air and a bottom heater
- Possible to measure and record temperature of components and P.W.B. with type K thermocouple
- The dedicated software to link a station and a computer for easy and quick settings
- Easy data transfer through an USB cable

Common Features of FR-810B and FR-811

New user friendly functions for SMD rework

Pickup indicator

The indication comes up and the moment of picking up will be visible.



Vacuum pickup function

This can avoid an error to peel off the land by removing components with excessive force.

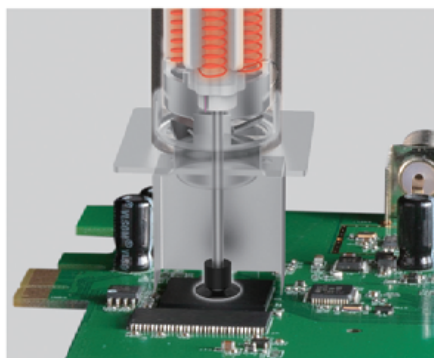

New type of nozzles

The new nozzles improve work efficiency with uniform heating (only with BGA nozzles).

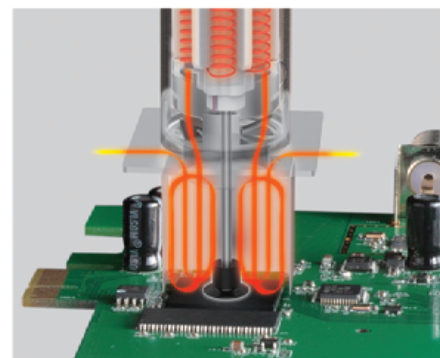

Efficiency improvement

The high volume airflow and high output of FR-810B and FR-811 make it possible to perform the same work in only one-third of the time required when using a conventional model. This reduces the thermal impact on boards and components.

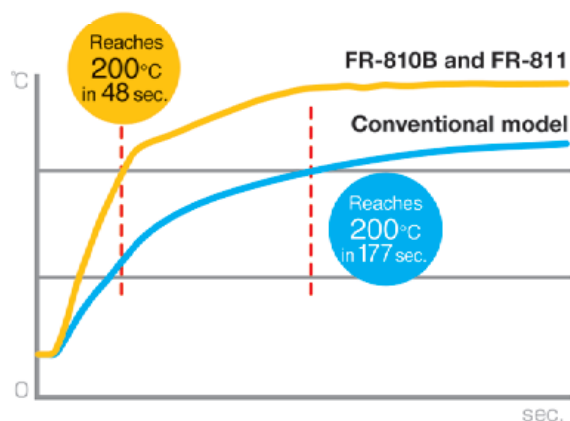

Test criteria

Model	FR-810B	Conventional model
Measurement method	Examination of time taken for connector sections soldered onto a ceramic board to be heated 200°C	
Board	Ceramic board	
Component used	Connector	
Nozzle shape	N51-02	A1130
Temperature setting	600°C	500°C
Air flow setting	9 (115 L/min.)	20 L/min.

Quick-change N51 nozzles



Simple heater replacement



Specifications

Port No.	FR-810B	FR-811
Power consumption	700 W (100 V), 840 W (110 V), 820 W (120 V), 1100 W (220 V), 1200 W (230 V), 1300 W (240 V)	
Temperature range	50 to 600°C	

Station

Power consumption	30 W	
Air flow*	1 to 9 (5 to 115 L/min.)	001 to 100% (5 to 115 L/min.)
Dimensions	160 (W) × 145 (H) × 220 (D) mm	
Weight	1.5 kg	

Handpiece

Power consumption	1170 W	
Standard nozzle	ø4 mm (No. N51-02)	—
Total length**	250 mm	
Weight**	180 g	

* Airflow capacity is rated as free flowing. Restrictions created by various nozzles may reduce the maximum airflow capacity.

** Without cord

Packing List

FR-810B	Station with handpiece, Nozzle (ø4 mm), Handpiece holder, Vacuum pipe control knob L (with screw), Pads (qty 2 each of ø3 mm, ø5 mm, ø7.6 mm), Heat resistant pad, Power Cord, Temperature distribution chart, Instruction manual
FR-811	Station with handpiece, Grip stand assembly, Vacuum pipe control knob L (with screw), Pads (qty 2 each of ø3 mm, ø5 mm, ø7.6 mm), USB cable, Software (CD-ROM), Thermocouple, Heat resistant pad, Power Cord, Temperature distribution chart, Instruction manual

Option

Part No.	Name	Specifications
C5027	Board holder	—
C5028	Grip fixture M	With hexagon wrench, o-ring and tray
C5029	Grip fixture L	With hexagon wrench and o-ring
B5098	Board clip	—
B5136	Board support unit	—
C5013*	Bottom heater	For FR-811

* Please ask about correct part number to the nearest HAKKO dealer or distributor in your area.

SMD Rework Station

Common Features of FR-810B and FR-811

Auto sleep and auto shutoff features

To ensure safety and conserve power, when the handpiece is placed in the handpiece holder, the auto sleep function is activated and it starts cooling automatically. If the handpiece has not been removed from the handpiece holder (example: using it in a rework fixture) and after it has been idle for 30 minutes, auto shutoff function is activated. It is automatically powered off. Access to settings can be restricted via the password function for easy management.



Handpiece holder No.B5048 in the picture can be attached to FR-811 as well (option).

Preset mode

	Preset 1	Preset 2	Preset 3	Preset 4	Preset 5
Temperature (°C)	250	300	350	400	450
Time (sec.)	100	80	50	120	150
Airflow (level)	6	7	8	4	5

Chain presets function for making a simple thermal profile

The chain presets function is to make a simple thermal profile by combining several preset conditions (up to 5 steps).

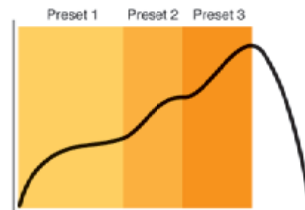

	Temperature (°C)	Time (s)	Airflow
Preset 1	250	100	6
Preset 2	300	40	6
Preset 3	350	50	6
Preset 4	100	000	6
Preset 5	100	000	6

* Presets 4 and 5 have been set to '000', so they are skipped.

Features of FR-811

Interface designed for intuitive operation. Possible to link to a PC.



Easy-to-read LCD

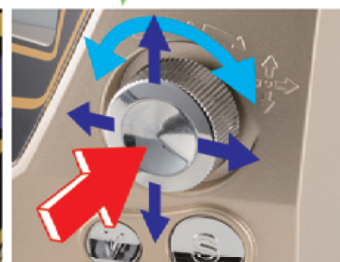

Easy-to-operate multi-direction control knob



A USB device terminal for easy data transfer



Link to a PC (A USB I/F terminal is available)

The functions needed for SMD rework are in a compact body.

Possible to make full-scale thermal profiles with 6-zone hot air and a bottom heater

A basic thermal profile is composed of the 5 parts shown below. FR-811 can provide 6 zones in which temperature, time, and airflow are controlled. Therefore FR-811 can make a full-scale thermal profile which is close to reflow profiles made by a reflow oven.

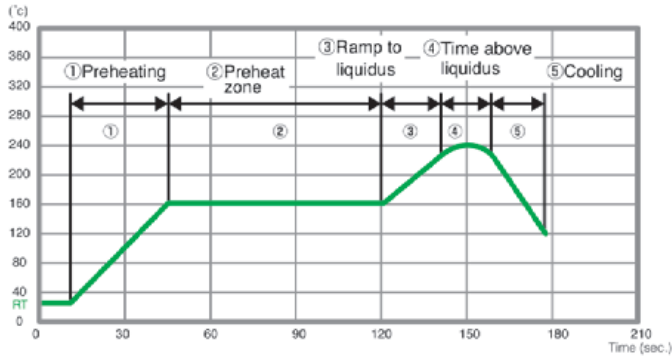

Record thermal data

By connecting a thermocouple included with FR-811, the temperature of the component or circuit board can be measured and recorded. In addition, if "TC LINK" is set, the heater output can be automatically controlled so that the temperature of the thermocouple attached to the component or circuit board follows the set profile.



Operation on a PC for various settings

By connecting FR-811 and a computer with a USB cable and using the dedicated software which comes as standard, a set thermal profile and actual temperature change can be shown in a graph in real time. The set values and graph can be saved in csv format.

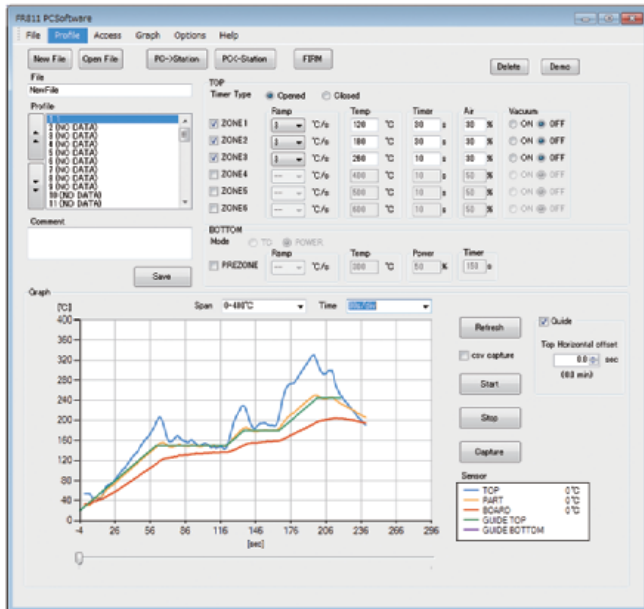

Linked operation with the bottom heater

FR-811 can control on/off timing and output of the bottom heater which is available optionally.

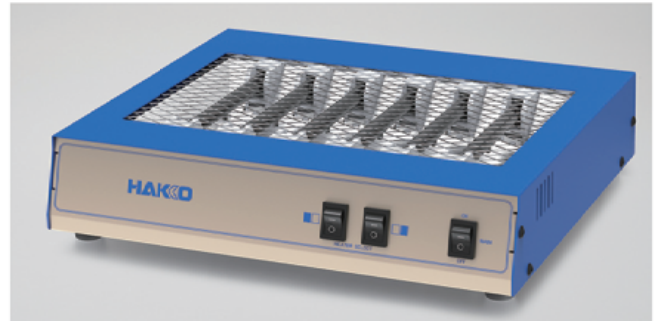

SMD Rework Station

Common Features of FR-810B and FR-811

Assembly of a low-cost SMD rework system

A low cost rework system can be assembled with a bottom heater, a grip fixture, and a board holder.

* The following pictures are set-up examples.

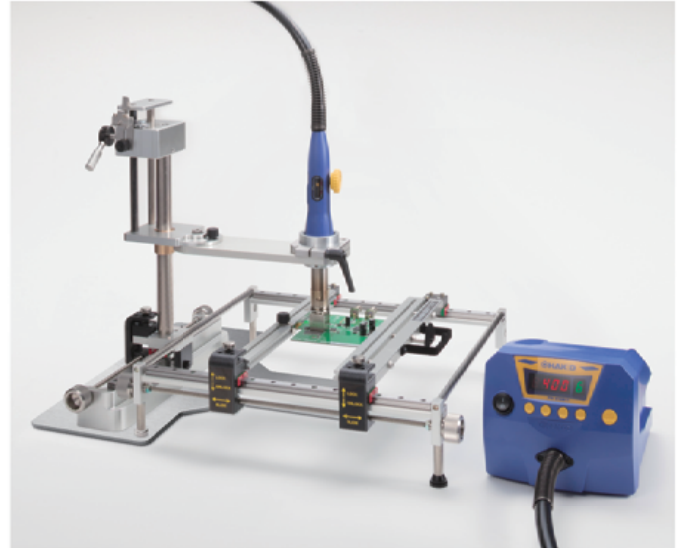
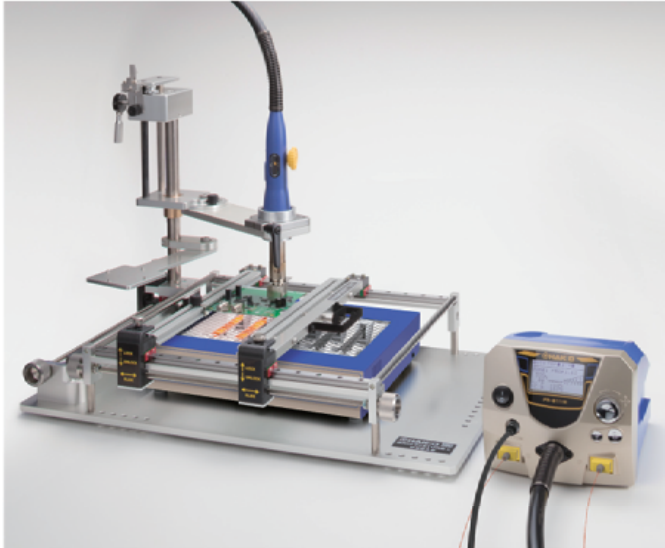

Option

Grip Fixture L



A board holder can be easily attached to the large baseplate.

Grip Fixture M



Recommended if a bottom heater is not required or in case of use of a bottom heater other than the dedicated model for FR-811.

The dedicated bottom heater for FR-811



Equipped with carbon heaters. Heating area is divided into 2 sections.

Board Holder

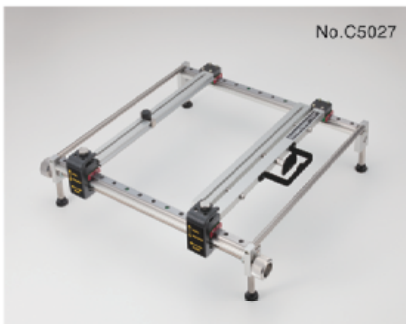

Makes it easy to set and remove a P.W.B. and to make fine adjustments after setting.

Board Clip

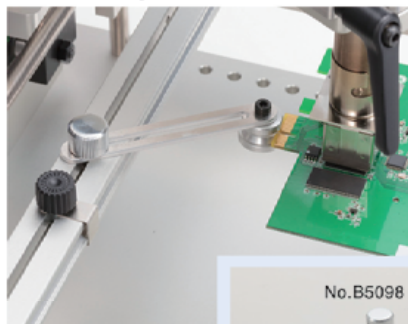

Accepts even irregular-shaped P.W.B.

Board Support Unit

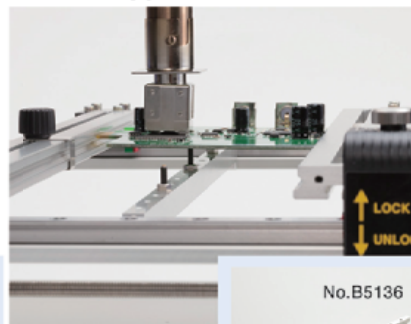

Supports P.W.B. from underneath to minimize its warping.

Optional Nozzles (Quick-change type) for FR-810B, FR-811 and FR-702

Unit: mm

Single	N51-01* Single 2.5	N51-02 Single 4	N51-03 Single 5.5	N51-04 Single 7	N51-05* Bent Single 1.5 x 3
BGA	N51-10 BGA 4 x 4	N51-11 BGA 6 x 6	N51-12 BGA 8 x 8	N51-13 BGA 10 x 10	N51-14 BGA 12 x 12
	N51-15 BGA 14 x 14	N51-16 BGA 15 x 15	N51-17 BGA 17 x 17	N51-18 BGA 18 x 18	N51-19 BGA 20 x 20
	N51-20 BGA 22 x 22	N51-21 BGA 24 x 24	N51-22 BGA 27 x 27	N51-23 BGA 29 x 29	N51-24 BGA 35 x 35
	N51-25 BGA 38 x 38	N51-26 BGA 40 x 40			

* The vacuum function does not operate with these nozzles.

Single nozzle set (N51-01, N51-03, N51-04, and N51-05) is also available.

* N51-02 included with FR-810B

No. N51-50







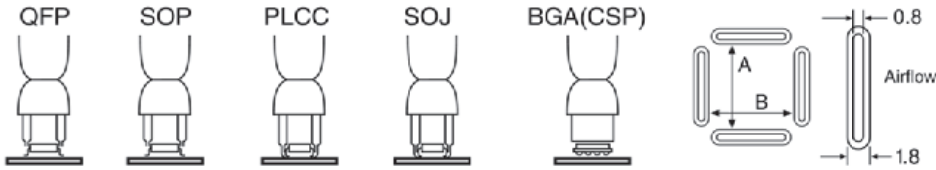









Optional Nozzles (Conventional type) for FR-810B, FR-811 and FR-702

Unit: mm













The size in each description indicates the size of the package.









QFP and BQFP

A1125B QFP 10 × 10  A: 10.2 B: 10.2	A1262B QFP 12 × 12  A: 12.2 B: 12.2	A1126B QFP 14 × 14  A: 15.2 B: 15.2	A1128B QFP 14 × 20  A: 15.2 B: 21.2	A1127B QFP 17.5 × 17.5  A: 19.2 B: 19.2
A1261B QFP 20 × 20  A: 20.2 B: 20.2	A1129B QFP 28 × 28  A: 29.7 B: 29.7	A1263B QFP 28 × 40  A: 27.7 B: 39.7	A1265B QFP 32 × 32  A: 32.2 B: 32.2	A1203B QFP 35 × 35  A: 35.2 B: 35.2
A1264B QFP 40 × 40  A: 40.2 B: 40.2	A1215B QFP 42.5 × 42.5  A: 42.5 B: 42.5	A1180B BQFP 17 × 17  A: 18.2 B: 18.2	A1181B BQFP 19 × 19  A: 19.2 B: 19.2	A1182B BQFP 24 × 24  A: 24.2 B: 24.2



SOP and TSOL

A1131* SOP 4.4 × 10  4.8	A1132* SOP 5.6 × 13  5.7	A1133* SOP 7.5 × 15  7.2	A1134* SOP 7.5 × 18  7.2	A1258B SOP 7.6 × 12.7  8.2
A1260B SOP 8.6 × 18  8.7	A1257B SOP 11 × 21  11.7	A1259B SOP 13 × 28  13.5	A1185B TSOL 13 × 10  11.9	A1186B TSOL 18 × 10  18.2
A1187B TSOL 18.5 × 8  18.5				



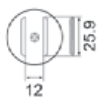

PLCC

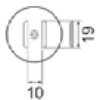
A1188B PLCC 9 × 9 (20 pins)  A: 11 B: 11	A1140B PLCC 11.5 × 11.5 (28 pins)  A: 13 B: 13	A1141B PLCC 11.5 × 14 (32 pins)  A: 15 B: 13	A1139B PLCC 12.5 × 7.3 (18 pins)  A: 9 B: 14	A1135B PLCC 17.5 × 17.5 (44 pins)  A: 18.5 B: 18.5
A1136B PLCC 20 × 20 (52 pins)  A: 21 B: 21	A1137B PLCC 25 × 25 (68 pins)  A: 26 B: 26	A1138B PLCC 30 × 30 (84 pins)  A: 31 B: 31	A1189B PLCC 34 × 34 (100 pins)  A: 36.5 B: 36.5	



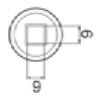

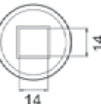
SOJ

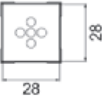
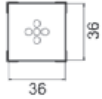
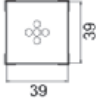
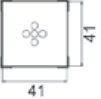
A1214B SOJ 10 x 26 	A1183* SOJ 15 x 8 	A1184B SOJ 18 x 8 
--	---	---

BGA

A1470 BGA 8 x 8 	A1471 BGA 12 x 12 	A1472 BGA 13 x 13 	A1473 BGA 15 x 15 	A1474 BGA 18 x 18 
A1475 BGA 27 x 27 	A1476 BGA 35 x 35 	A1477 BGA 38 x 38 	A1478 BGA 40 x 40 	

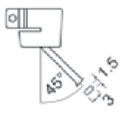
Single

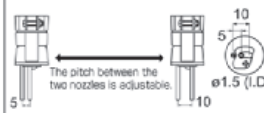
A1124B* Single 2.5 	A1130* Single 4.4 	A1142B* Bent single 1.5 x 3 	A1190* Dual single 2.5 x 9.5 	A1325* Dual single ø1.5 x 5 to 10 Adjustable pitch 
--	---	--	--	---

SIP

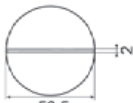
A1191* SIP 25L 	A1192* SIP 50L 
--	--

* The vacuum function does not operate with these nozzles.

FR-701

ESD SAFE

Nozzle quick change type

Repair System

Digital



- All-in-one repair system that enables both soldering and desoldering

Features

For information on features of soldering iron, see P. 25.
For information on features of desoldering tool, see P. 79.

NOTE: Auto Shutoff Function and Auto Sleep Function are available for desoldering tool only.

Packing List

FR-701	Station, Soldering iron (FX-8801), Desoldering tool (FR-4103), Iron holder for soldering iron (with cleaning sponge and wire), Iron holder for desoldering tool (with cleaning wire), Tool box (Cleaning pin for $\phi 1$ mm, Cleaning pin for heating element, Cleaning drill for $\phi 1$ mm, Nozzle wrench, Filter [qty 2], Ceramic paper filter L [qty 4]), Power cord, Instruction manual
--------	--

Replacement Tips and Nozzles

For information on optional irons and replacement tips, see P. 27 to 29.
For information on replacement nozzles for desoldering tool FR-4103, see P. 80.

Specifications

Part No.	FR-701
Power consumption	260 W

Station (Soldering iron)

Output voltage	AC 26 V
Temperature range	50 to 480°C
Temperature stability	$\pm 1^\circ\text{C}$ at idle temperature (when set to 200 to 480°C)

Station (Desoldering tool)

Output voltage	AC 24 V
Vacuum generator	Vacuum pump, double cylinder type
Vacuum pressure	80 kPa (600 mmHg, max.)
Suction flow	15 L/min.
Temperature range	330 to 450°C
Temperature stability	$\pm 5^\circ\text{C}$ at idle temperature

Station

Dimensions	190 (W) × 140 (H) × 220 (D) mm
Weight	6.2 kg

Soldering iron

Power consumption	65 W (26 V)
Tip to ground resistance	$< 2 \Omega$
Tip to ground potential	< 2 mV
Heating element	Ceramic heater
Standard tip	Shape-B (No. T18-B)
Cord length	1.2 m
Total length*	217 mm (with B tip)
Weight*	46 g (with B tip)

Desoldering tool

Power consumption	140 W (24 V)
Nozzle to ground resistance	$< 2 \Omega$
Nozzle to ground potential	< 2 mV
Heating element	Composite heater
Standard nozzle	$\phi 1$ mm S type (No. N61-05)
Cord length	1.2 m
Total length**	168 mm (with $\phi 1$ mm S type nozzle)
Weight**	190 g (with $\phi 1$ mm S type nozzle)

* Without cord

** Without cord and hose

FR-702

ESD SAFE

Nozzle quick change type

Rework System

Digital



NEW
FR-4103



- Multi-station that enables soldering, desoldering, and SMD rework all with a single unit

Features

For information on features of soldering iron, see P. 25.
For information on features of desoldering tool, see P. 79.
For information on features of hot air, see P. 85 to 88 (common features).
NOTE: Auto Shutoff Function and Auto Sleep Function are available for desoldering tool and hot air only.
Low Temperature Error Alert is available for soldering iron and desoldering tool only.

Packing List

FR-702	Station with hot air handpiece, Nozzle (ø4 mm) for hot air, Handpiece holder for hot air, Vacuum pipe control knob L (with screw), Pads (qty 2 each of ø3 mm, ø5 mm, ø7.6 mm), Soldering iron (FX-8801), Desoldering tool (FR-4103), Iron holder for soldering iron (with cleaning sponge and wire), Iron holder for desoldering tool (with cleaning wire), Tool box (Cleaning pin for ø1 mm, Cleaning pin for heating element, Cleaning drill for ø1 mm, Nozzle wrench, Filter [qty 2], Ceramic paper filter L [qty 4]), Heat resistant pad, Color band (qty 2), Power cord, Instruction manual
--------	--

Replacement Tips and Nozzles

For information on optional irons and replacement tips, see P. 27 to 29.
For information on replacement nozzles for desoldering tool FR-4103, see P. 80.
For information on replacement nozzles for hot air, see P. 89 to 91.

Specifications

Part No.	FR-702
Power consumption	1030 W (100 V), 1170 W (110 V), 1430 W (220 V), 1530 W (230 V), 1630 W (240 V)

Station (Soldering iron)

Output voltage	AC 26 V
Temperature range	50 to 480°C
Temperature stability	±1°C at idle temperature (when set to 200 to 480°C)

Station (Desoldering tool)

Output voltage	AC 24 V
Vacuum generator	Vacuum pump, double cylinder type
Vacuum pressure	80 kPa (600 mmHg, max.)
Suction flow	15 L/min.
Temperature range	330 to 450°C
Temperature stability	±5°C at idle temperature

Station (SMD rework station)

Power consumption	30 W
Air flow*	1 to 9 (5 to 115 L/min.)
Temperature range	50 to 600°C

Station

Dimensions	370 (W) × 150 (H) × 220 (D) mm
Weight	9 kg

Soldering Iron

Power consumption	65 W (26 V)
Tip to ground resistance	<2 Ω
Tip to ground potential	<2 mV
Heating element	Ceramic heater
Standard tip	Shape-B (No. T18-B)
Cord length	1.2 m
Total length**	217 mm (with B tip)
Weight**	46 g (with B tip)

Desoldering tool

Power consumption	140 W (24 V)
Nozzle to ground resistance	<2 Ω
Nozzle to ground potential	<2 mV
Heating element	Composite heater
Standard nozzle	ø1 mm S type (No. N61-05)
Cord length	1.2 m
Total length***	168 mm (with ø1 mm S type nozzle)
Weight***	190 g (with ø1 mm S type nozzle)

Handpiece (Hot air)

Power consumption	670 W (100 V), 810 W (110 V), 1070 W (220 V), 1170 W (230 V), 1270 W (240 V)
Standard nozzle	ø4 mm (No. N51-02)
Total length**	250 mm
Weight**	180 g

* Air flow capacity is rated as free flowing. Restrictions created by various nozzles may reduce the maximum airflow capacity.

** Without cord.

*** Without cord and hose.

FR-870B ESD SAFE

IR Preheater **Digital**



- Infrared preheater that provides the optimal heating effect over the whole workpiece surface
- Non-contact system enables the application of this preheater to doublesided boards.
- 2 independent switchable work grid partitions

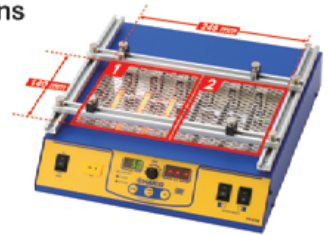

FR-872 ESD SAFE

Large Size IR Preheater **Digital**



- Large heating area 286 (W) x 350 (D) mm
- 4 independent switchable work grid partitions



FR-830 ESD SAFE

Preheater **Analog**



- Compact pre-heater best suited for heat processing on localized areas
- Featuring quick heatup and less variations in temperature



Features of FR-870B and FR-872

Power Mode

Control heater output from 0% to 100%.

T/C Mode

Sense the temperature of the sensor attached to the board and control to maintain the set temperature for the board.



Auto Mode

Auto mode provides three steps (step 1 to 3) to create an optimal heating profile for the workpiece.

With Power Mode

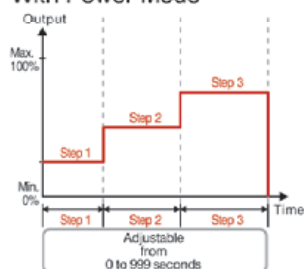

With T/C Mode

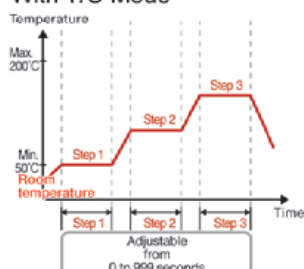

Features of FR-830

Preheating in a short time

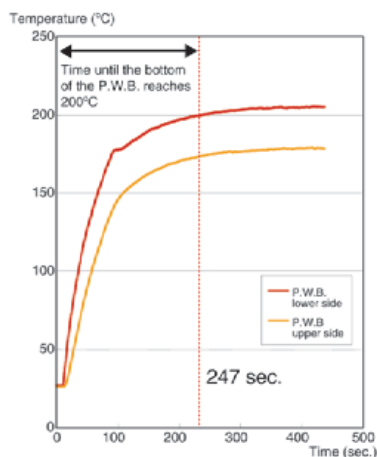

Test criteria

Measurement method	Temperature measured using sensors mounted on both the top and bottom surfaces of the P.W.B.
Distance between air outlet and P.W.B.	10 mm
Temperature setting	300°C

Packing List

FR-870B	Unit, Thermocouple, Power cord, Heater lamp, Instruction manual
FR-872	Unit, Thermocouple, Heater, Power cord, Instruction manual

Specifications

Model No.	FR-870B	FR-872
Power consumption	500 W (100 V) 610 W (110 V) 730 W (120 V) 1130 W (220 V) 1240 W (230 V)	1050 W (100 V) 1250 W (110 V) 1440 W (120 V) 1150 W (220 V) 1250 W (230 V)
Operation mode	Power mode, T/C mode Auto power mode, Auto T/C mode	
Setting range	Power mode: 0 to 100% T/C mode: 50 to 200°C Set time: 0 to 999 seconds	
Heating element	Carbon heater	High efficiency carbon heater
Heater area dimensions	248 (W) × 140 (D) mm	286 (W) × 350 (D) mm
Heater zone	2	4
Temperature sensor	K-type thermocouple	
Heater lamp lifetime*	2100 hours	2100 hours
Heater control	Power mode: Percentage-based system T/C mode: PID control	
External connections	Start signal input possible	
Dimensions	290 (W) × 100 (H) × 311 (D) mm	AC 100 to 120 V: 360 (W) × 97 (H) × 535 (D) mm AC 220 to 230 V: 360 (W) × 97 (H) × 524 (D) mm
Weight	3.2 kg	5.6 kg

* Provided for reference purpose only and is not guaranteed.

Packing List

FR-830	Unit, Power cord, Instruction manual
--------	--------------------------------------

Specifications

Model No.	FR-830
Power consumption	210 W (100 V), 240 W (110 V), 470 W (120 V), 230 W (220 V), 250 W (230 V), 270 W (240 V)
Air flow	0.15 m ³ /min. (fan capability)
Temperature range	150 to 300°C (above the hot air outlet)
Dimensions*	140 (W) × 75 (H) × 185 (D) mm
Weight	0.75 kg

* The height (H) is the distance from the bottom of the feet to the top of the exhaust outlet.

Option

Part No.	Name	Specifications
B3263	Extension pipe	with lid
B2763	Hand switch	-
B1649	Foot switch	-

FA-430 ESD SAFE

Air-Purifying Smoke Absorber



- HEPA filter (High Efficiency Particulate Air Filter)
- Filters out 99.97% of particles greater than 0.3 μm
- Recommended for quiet laboratory and office

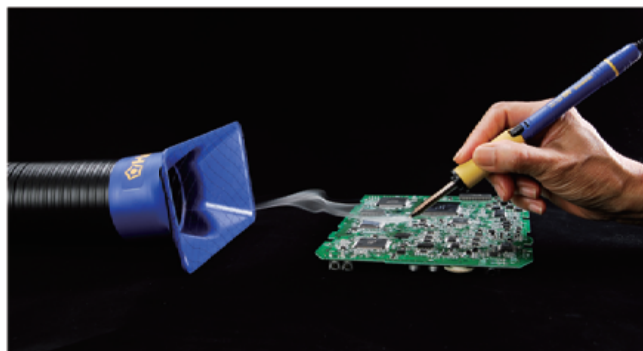

Features of FA-430

Filter efficiency is 99.97% of particles greater than 0.3 μm (HEPA filter).

Aerosol particle diameter range

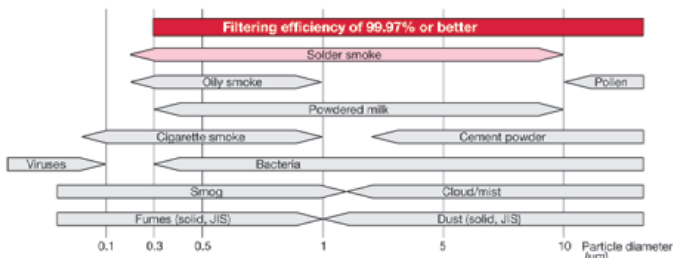

NOTE: Filter efficiency is an initial value of collection efficiency based on counting method for airborne dust collected by a single plate of filter (unfolded).

Packing List

FA-430	Main unit, Power cord, Cap, Main filter, Pre-filter (qty 10), Instruction manual
--------	--

* Ducts are optional parts.

Filter replacement notification function

Pre-filter

When the pre-filter is 80% clogged or has been used for 200 hours, the orange indicator flashes on and off.

HEPA main filter

When the 10th pre-filter needs replacing, the orange and red lamps flash on and off.

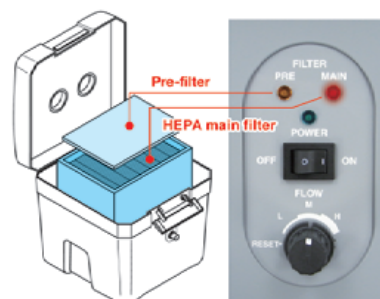

Specifications

Model No.	FA-430	
Power consumption	110 W	
Noise level*	50 dB (A) (MEDIUM mode)	
Suction capacity**	HIGH	4.7 m ³ /min.
	MEDIUM	3.7 m ³ /min.
	LOW	2.8 m ³ /min.
Filtering efficiency	HIGH	99.96% (0.3 μm)***
	MEDIUM	99.97% (0.3 μm)***
	LOW	99.97% (0.3 μm)***
Static pressure	1500 Pa	
Duct set (sold separately)****	ø55 mm × 1.2 m (ESD SAFE)	
Dimensions	330 (W) × 366 (H) × 343 (D) mm	
Weight	7.5 kg	

* Measured at a distance of 1 meter from the face of the unit in an anechoic chamber.

** When using two ducts

*** It is an initial value of collection efficiency based on counting method for airborne dust collected by a single plate of filter (unfolded).

**** Nets in duct sets are not protected against electrostatic discharge.

FA-431 ESD SAFE

Air-Purifying Smoke Absorber



- Excellent cost performance filter
- Filters out 97% of particles greater than 0.3 μm
- Optional sub-filters extend the life of Pre and Main filters
- Ideal for factories with a lot of soldering work

Features of FA-431

The life of pre-filter and main filter will be approximately 4 times* longer.

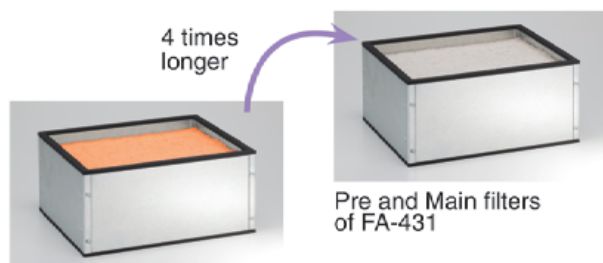

Pre and Main filters of FA-430

Pre and Main filters of FA-431

With the use of sub-filter, it will be approximately 10 times* longer.

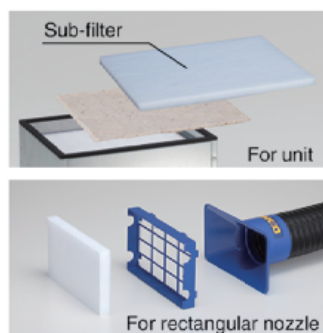

Remote control equipped
Very easy to switch ON/OFF



* The filter life will be differ depending on the work environments and work conditions.

Packing List

FA-431	Main unit, Power cord, Remote control, Cap, Main filter, Pre-filter (qty 10), Instruction manual
--------	--

* Ducts are optional parts.

Specifications

Model No.	FA-431	
Power consumption	110 W	
Noise level*	50 dB (A) (MEDIUM mode)	
Suction capacity**	HIGH	4.7 m ³ /min.
	MEDIUM	3.7 m ³ /min.
	LOW	2.8 m ³ /min.
Filtering efficiency	HIGH	97% ($\geq 0.3 \mu\text{m}$)
	MEDIUM	
	LOW	
Static pressure	1500 Pa	
Duct set (sold separately)***	$\phi 55 \text{ mm} \times 1.2 \text{ m}$ (ESD SAFE)	
Dimensions	330 (W) \times 366 (H) \times 343 (D) mm	
Weight	7.2 kg	

* Measured at a distance of 1 meter from the face of the unit in an anechoic chamber.

** When using two ducts

*** Nets in duct sets are not protected against electrostatic discharge.

Air-Purifying Smoke Absorber

Common Features of FA-430 and FA-431

Quiet operation and powerful suction

	FA-430/431		Previous model (HAKKO 421)	
	Noise level dB (A)	Air volume m ³ /min.	Noise level dB (A)	Air volume m ³ /min.
HIGH	53	4.7	60*	3.2*
MEDIUM	50	3.7		
LOW	44	2.8		

*Values measured when the unit was used with a 60 Hz power supply.

Flexible ducts and compact body for perfect placement



Movement of smoke is affected by the surrounding environment

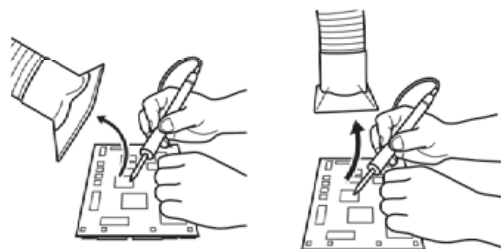

If the duct is mounted at an angle above the workpiece, it is affected by air conditioning.

If the duct is mounted directly above, it can be difficult to see the workpiece.

Recommended angle

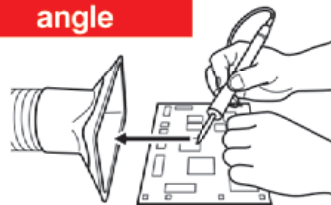

Duct is mounted on the worktable to provide excellent suction performance.

Freestanding ducts



Perfect placement provides suction where you need it.

Option

Part No.	Name	Specifications
C1571	Duct Set	With rectangular nozzle
C1572	Duct Set	With round nozzle
A5035	Sub-filter	For FA-431, set of 5
A5036	Sub-filter for rectangular nozzle	For FA-431, set of 20
A5037	Sub-filter for round nozzle	For FA-431, set of 20
B5146	Filter case for rectangular nozzle	For FA-431
B5147	Filter case for round nozzle	For FA-431



No.C1571



No.C1572

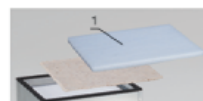

1: No.A5035

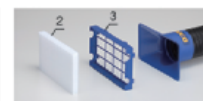

2: No.A5036
3: No.B5146

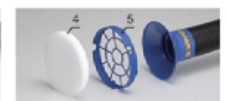

4: No.A5037
5: No.B5147

FA-400 ESD SAFE

Desktop Type Smoke Absorber



- Desktop solder smoke absorber that can be mounted horizontally or vertically
- An optional arm stand makes a third mounting position available.

2 Way Plus Placement

Vertically mounted:



Horizontally mounted:



Using a stand (option):



Packing List

FA-400	Unit, Filter, Instruction manual
--------	----------------------------------

Specifications

Model No.	FA-400
Power consumption	50 Hz: 15 W (100 V), 18 W (110 V), 19 W (220 V), 22 W (230 V), 24 W (240 V) 60 Hz: 13 W (100 V), 15 W (110 V), 19 W (120 V), 16 W (220 V), 18 W (230 V), 19 W (240 V)
Noise level*	50 Hz: 48 dB 60 Hz: 51 dB
Suction capacity**	Vertically: 1 m ³ /min. (50 Hz), 1.1 m ³ /min. (60 Hz) (max.) Horizontally: 0.4 m ³ /min. (50 Hz), 0.5 m ³ /min. (60 Hz) (max.)
Air velocity	Vertically: 1 m/sec. (50 Hz), 1.1 m/sec. (60 Hz) Horizontally: 2.6 m/sec. (50 Hz), 2.9 m/sec. (60 Hz)
Filter size	130 (W) × 130 (H) × 10 (D) mm
Dimensions	166 (W) × 212 (H) × 113 (D) mm
Weight***	0.91 kg

* Measured at a distance of 1 m from the face of the unit

** Measured with a filter present

*** Without cord

Option

Part No.	Name	Specifications
C1568	Arm stand	With knobs

490

External Air Compressor Type Smoke Absorber



- External air compressor type soldering smoke absorber
- Three inner filters attached on different levels absorb soldering smoke.
- Up to 2 soldering irons can be connected to one unit.

Compatible Soldering Station for HAKKO 490



FN-1010



FX-801



FX-838



FX-100



FX-951



FX-950



FM-203



FM-206



FX-888D



FX-889



DASH

Specifications

Model No.	490
Noise level	39 dB
Working pressure	392 to 686 kPa (4 to 7 kgf/cm ²)
Air consumption	40 L/min. (490 kPa)
Suction flow	23 L/min. (490 kPa)
Dimensions	ø120 × 200 (H) mm
Weight*	1.5 kg

* Unit only

** Use compressed air; no power supply is necessary.

Packing List

490	Unit, Absorption pipe set, Instruction manual
-----	---

* A second soldering iron can be attached to HAKKO 490 by purchasing an additional absorption pipe set.

494

Smoke Absorbing System



- Soldering smoke absorber for production-line use that enables the exhausting of fumes to an outdoor location
- Equipped with a suppressor to reduce exhaust noise during operation
- Up to 10 soldering irons can be connected to one unit

Example of Connections

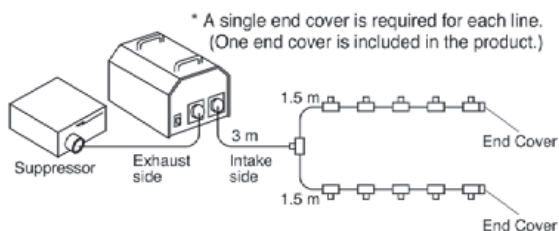

Packing List

494	Unit, Filter case, Filter cap, Pre-filter (5 pcs), Duct (3 m), End cover, Main filter (5 pcs), Inlet socket, Exhaust duct (5 m), Nylon strap, Suppressor, Absorption pipe set, Instruction manual
-----	---

*When ordering HAKKO 494, specify the part number of the absorption pipe set.

Option

Part No.	Name	Specifications
C1540	Absorption pipe set <R>	Any with a handle $\phi 16$ mm or smaller
B1246	Parallel piping joint	-

Specifications

Model No.	494
Power consumption	50 Hz: 150 W 60 Hz: 200 W
Noise level*	With hose: 55 dB Without hose: 71 dB
Suction capacity	50 Hz: 1.56 m ³ /min. 60 Hz: 1.82 m ³ /min.
Static pressure	50 Hz: 2.3 kPa (240 mmAq.) 60 Hz: 3.2 kPa (325 mmAq.)
Dimensions**	322 (W) × 300 (H) × 386 (D) mm
Weight***	18 kg

* Measured at a distance of 1 m from the face of the unit.

** Without handle and cord

*** Unit only

FE-510

Static Eliminator



- Static eliminator enables the selection of the area in which static will be neutralized.
- Locking mechanism maintains the angle of the eliminator unit.
- Error output signal function is useful when incorporating the unit into line applications.

Features

Static elimination area

Wide-angle louver

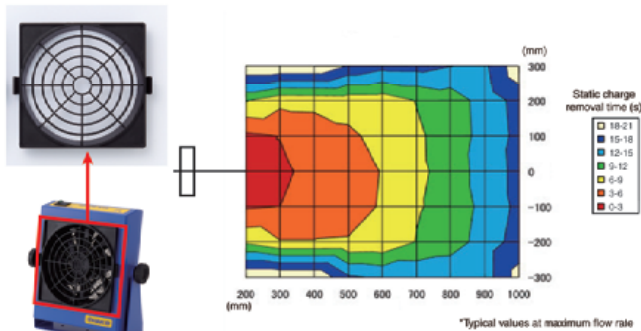

Straight louver

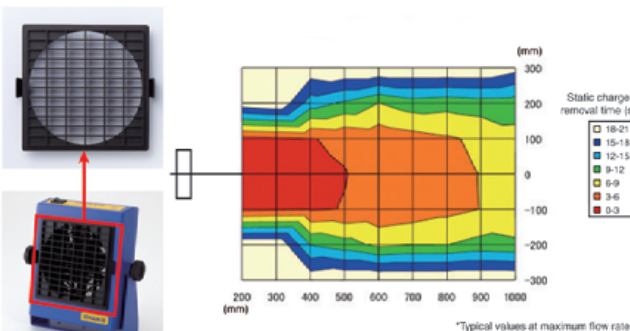

Error output signal



Superb ease of maintenance

The discharge electrode can be replaced simply by turning it gently in the clockwise direction.



Packing List

FE-510

Unit (with wide-angle louver), Straight louver, Cleaning brush, Filter, AC adapter, Output signal connection lead (1 set), Instruction manual

Specifications

Model No.	FE-510
AC adapter output/Capacity	DC 24 V 10 VA
Discharge method	High frequency AC method
High voltage output	Approx. AC 2000 V
Ion balance*	±10 V or less
Static elimination time*	Straight louver: Approx. 1.5 sec. Wide-angle louver: Approx. 2.5 sec.
High voltage abnormality output (ALARM)	MOS FET relay output Maximum allowed current: 100 mA Applied voltage: DC 30 V or less
Cleaning check output (C.C)	MOS FET relay output Maximum allowed current: 100 mA Applied voltage: DC 30 V or less
Air flow	1.5 to 3 m ³ /min.
Air flow out angle	Vertically 360° variable (every 10°)
Quantity of produced ozone**	0.04 ppm or less
Operating environment	Ambient temperature: 0 to 40°C Ambient humidity: 15 to 65% (without condensation)
Material for discharge electrode	Tungsten
Dimensions	150 (W) × 182 (H) × 50 (D) mm (without stand)
Weight***	0.79 kg

AC adapter

AC adapter output/Capacity	DC 24 V 1 A
Dimensions	34 (W) × 72 (H) × 51 (D) mm
Weight	100 g

* Typical value measured (before shipment) at a distance of 300 mm from the center of the fan outlet with the maximum flow rate

** Measured at a point 150 mm away from the center of the fan outlet

*** Including stand

442B

Wrist Strap



- This antistatic wrist strap prevents the human body from becoming charged with static electricity.
- The stretchable band is easy to adjust.
- A conductive thread is used for the band lining.

Specifications

Part No.	442B-01	442B-02	442B-04	442B-05	442B-06	442B-07
Color	Blue		Light green		Gray	
Grounding wire	1.5 m	2.5 m	1.5 m	2.5 m	1.5 m	2.5 m

Wrist Strap Tester

FG-470 New

Wrist Strap Tester



- Easy-to-use, quick-response tester for wrist straps
- A user-friendly pad secures pass/fail judgement on a wrist strap.
- Highly visible LED lamps and buzzer will indicate test result.

* Buzzer sounds only for "PASS".

Features

Connection patterns to choose depending on wrist straps

* Banana plug and grounding wire are included in FG-470.



Dedicated holder included

A mounting holder can make it easy to plug and unplug even with one hand. No tool is required to remove a unit. A unit can be portable off the holder.



* Example of installation

* 4 Wood screws provided

Packing List

FG-470	Unit, 006P 9 V dry battery (for trial), Grounding wire, Banana plug, Mounting holder, Wood screws (qty 4), Instruction manual
--------	---

Specifications

Model No.	FG-470	
Power supply	006P 9 V dry battery (alkaline cell recommended)	
Indication	LOW	$R < 800 \text{ k}\Omega$
	PASS	$800 \text{ k}\Omega \leq R \leq 9 \text{ M}\Omega$
	HIGH	$R > 9 \text{ M}\Omega$
Judgment level accuracy	800 kΩ	+ 10% / - 0%
	9 MΩ	+ 0% / - 10%
Battery life	Approx. 50,000 times (9 V alkaline)	
Grounding wire	1 m	
Operating environment	0 to 40°C, 20 to 90%RH (without condensation)	
External dimensions	85 (W) × 44 (H) × 90 (D) mm	
	With mounting holder	92 (W) × 48 (H) × 97 (D) mm
Weight*	120 g	
	With mounting holder	160 g

* Without battery

FG-460

Footwear Tester

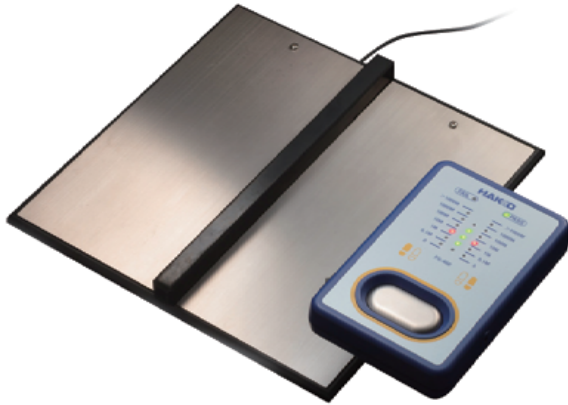

- Very easy-to-use footwear tester
- Information of measurement and evaluation of electrical resistance at a glance
- Meet the criteria of standards such as JIS T 8103:2010 and ANSI/ESD S20.20

Features

Individual measurement

Measure the anti-static performance of shoes individually. Prevents faulty measurement with the divider on test plate.

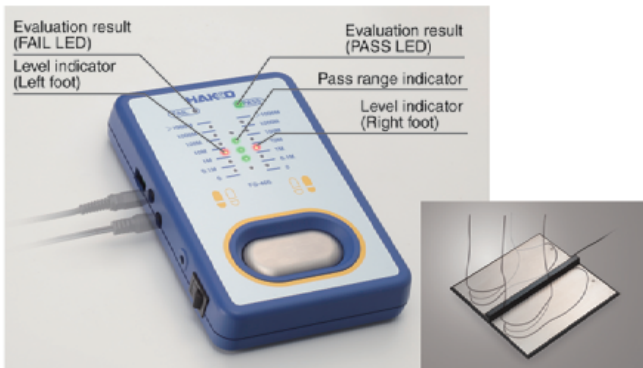

Evaluation external output

Side view



External output terminal

Example of interlock



Optional Stand (C5032)



Packing List

FG-460	Unit, Mounting base, AC adapter*, Test plate, Mounting screw (qty 2)***, Pan head screw (qty 2), Wood screw (qty 2), Instruction manual
---------------	---

* AC adapter may not be included depending on the specifications.

** Delivered as they are screwed onto the unit.

NOTE: Stand (C5032) is sold separately.

Specifications

Model No.	FG-460	
Rating	DC 24 V 33 mA	
Measurement voltage	DC 20 V	
Measurement range	Upper evaluation limit	1000 M Ω ($1 \times 10^9 \Omega$) 100 M Ω ($1 \times 10^8 \Omega$) 10 M Ω ($1 \times 10^7 \Omega$)
	Lower evaluation limit	1 M Ω ($1 \times 10^6 \Omega$) 0.1 M Ω ($1 \times 10^5 \Omega$) R < 0.1 M Ω ($1 \times 10^5 \Omega$)
	Conductivity evaluation	R < 0.1 M Ω ($1 \times 10^5 \Omega$)
Evaluation level accuracy	R < 0.1 M Ω	$\pm 5\%$
	0.1 M Ω \leq R \leq 100 M Ω	$\pm 10\%$
	100 M Ω < R	$\pm 8\%$
Operating environment	Ambient temperature / humidity range 0 to 40°C, 20 to 90%RH (without condensation)	
Environment condition	Applicable rated pollution degree 2 (according to IEC / UL61010-1)	
Dimensions	120 (W) \times 30 (H) \times 185 (D) mm	
Weight*	0.55 kg	

Test plate

Cord length	1.6 m
Dimensions**	300 (W) \times 30 (H) \times 300 (D) mm
Weight**	1.9 kg

AC adapter

Output voltage	DC 24 V
----------------	---------

* Including mounting base

** Without cord

Option

Part No.	Name
C5032	Stand

FG-450

Static Level Meter



- Portable static level meter for the measurement of electric potential of films and plastic objects
- Useful when checking electric potential measurements in production lines.
- Also suitable for performing operation test of static eliminators.

Features

Rotating sensor head



Selectable two modes in measurement

- Measuring static electricity (resolution: 10 V)



The red light image is projected to a point about 30 mm from the meter.



- Measuring ion balance (resolution: 1 V)



Packing List

FG-450	Unit (with carrying case), Grounding wire, Strap, 006P 9 V Manganese dry battery (for trial), Ion balance plate (with screw), Instruction manual
--------	--

Specifications

Model No.	FG-450
Power supply	006P 9 V dry battery
Measurable potential range	Normal mode: 0.00 to ±19.99 kV (resolution: 0.01 kV) Ion balance mode: 0.000 to ±1.999 kV (resolution: 0.001 kV)
Signal detection method	Oscillating chopper method
Display refresh frequency	0.5 seconds
Measurement precision	±10% of reading ±2 digits
Continuous operating limit	Approx. 10 hours (with an alkaline battery)
Measurement distance	30 mm (between object being measured and sensor)
Measurement distance adjustment	Red LED beam focusing method
Sensor head rotation angle	180° (stops every 45°)
Display	LCD display with built-in backlight
Polarity display	Positive polarity/negative polarity display
Mode switching	Switch modes by pressing MODE button
Battery check	Remaining charge displayed in display panel
Operating environment	0 to 40°C, 20 to 70%RH (without condensation)
Dimensions	68 (W) × 138 (H) × 22 (D) mm
Weight*	160 g

* Including battery

Option

Part No.	Name	Specifications
B3586	Body changing level measurement plate	-

FG-102

Soldering Iron Thermometer with Traceability Management System



- Free of errors in temperature measurement
- Free of transcription errors for measured temperature
- Standardization of temperature measurement
- Secure management of tip temperature records

Packing List

FG-102	Unit, Battery (6 pcs, for trial), Barcode reader, USB cable, Software (CD-ROM), Sensor (10 pcs), Barcode sticker for soldering iron ID (30 pcs), Barcode sticker for operator ID (30 pcs), Instruction manual
---------------	---

Option / Replacements

Part No.	Name	Specifications
A1310	Temperature probe	for soldering bath & pot
C1541	Temperature probe	for hot air station
A1556	Sensor A	–
A1557	Sensor B	–
C5009	Bar code reader	–
191-212	Sensor	lead-free, set of 10

Specifications

Model No.	FG-102
Power supply	AA sized (LR6) battery × 6 (alkaline cell recommended)
Temperature resolution	1°C
Temperature measurement range	0 to 700°C
Temperature precision	±3°C (300 to 600°C) ±5°C (other than above)
Temperature sensor*	K (CA) type thermocouple
Display	LCD
Operating environment	0 to 40°C, 20 to 90%RH (without condensation)
Environmental conditions	Applicable rated pollution degree 2 (according to IEC/UL 61010-1)
Dimensions**	193 (W) × 90 (H) × 219 (D) mm
Weight***	0.93 kg

* Temperature sensor (No.191-212 or No.191-212C) can only be used if measure temperatures below 500°C. To measure higher temperatures, use an applicable temperature probe.

** Without barcode reader

*** Without battery and barcode reader

**** Traceability management function can only be used for soldering irons.

Features

An Innovation in Tip Temperature Control

Flow chart of management

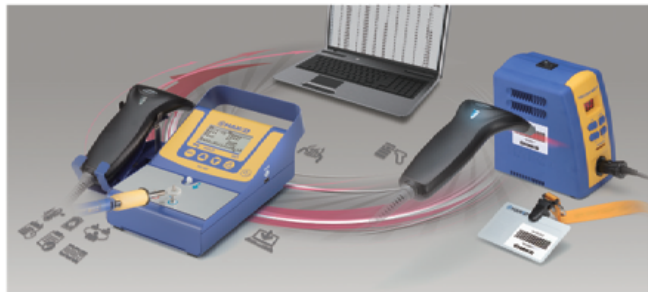

1. Scan the unit and the measurer's ID by a barcode reader.
2. Measure the temperature.
3. Press the REC button to save the data on the unit main body.
4. Transfer and save the data on the PC.

Free of errors in temperature measurement by standardization of temperature measurement

The unit has a function to notify the end of measurement. When measurement is finished, "H" icon stops blinking. The unit can find measurement errors and prompt an operator to repeat measurement. The display shows "Fail" if tip loses appropriate contact with sensor before completion of measurement.

Pass/Fail judgment on measured temperature

Pass/Fail judgment on measured temperature can be automatically made if an acceptable temperature range is registered in advance (the display shows "OK" or "Fail").

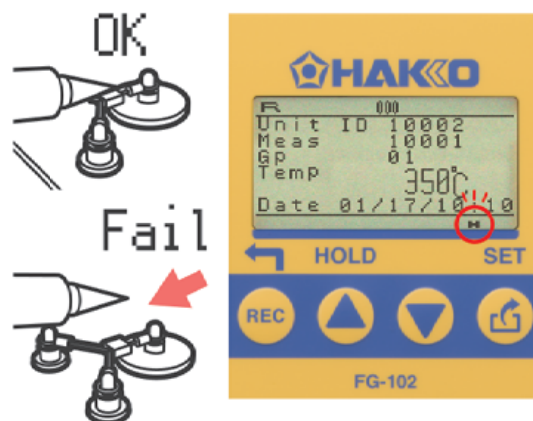

Make it easy to manage tip temperature records by transferring the data to computer



No	InstID	Gr No	MeasID	Temp	Set Temp	Month	day	hour	min	OK/NG
1	10023	0	10005	375	0	10	21	14	47	--
2	10024	0	10005	372	0	10	22	14	48	--
3	10025	0	10005	372	0	10	23	14	49	--
4	10026	0	10005	373	0	10	24	14	50	--
5	10027	0	10005	375	0	10	25	14	51	--
6	10028	0	10005	375	0	10	26	14	52	--
7	10029	0	10005	373	0	10	27	14	53	--
8	10030	0	10005	378	0	10	28	14	54	--
9	10001	1	10005	371	380	10	29	14	55	OK
10	10002	1	10005	371	380	10	30	14	55	OK
11	10003	1	10005	372	380	10	31	14	56	OK
12	10004	1	10005	382	380	10	32	14	57	OK
13	10005	5	10005	382	380	10	33	15	3	NG
14	10006	5	10005	380	380	10	34	15	4	NG

Free of transcription errors for measured temperature

More Features



Group control

Groups can be created based on different set temperatures for different operations. Pass/Fail judgment on measured temperatures can be automatically made for different acceptable temperature ranges.



Automatic counting of the number of measurements



Notification of the calibration date

FG-100B

Thermometer with Auto-measurement Function



- Automatic temperature measurement can minimize individual differences in measuring temperature.
- Measurement counter can be useful for control of changing sensor.
- Fine sensor can deliver accurate measurements.

FG-101

Soldering Iron Tester



- Tip temperature, leak voltage, and tip-to-ground resistance can be easily measured with high accuracy.
- Soldering iron tester useful for daily maintenance of station-type soldering irons
- When the “MAX HOLD” button is pressed, “MAX HOLD” is displayed and the highest tip temperature is held on the display.



What is leak voltage and tip-to-ground resistance?

Leak voltage

Leak current is the current that leaks from the tip to a board or device. Leak voltage is a specific measurement of the level of this current. The leakage can adversely affect delicate devices, so it is necessary to check leak voltage on a daily basis.



Tip-to-ground resistance

Most leak current flows from the tip via the ground wire to the outlet ground terminal, and is prevented from affecting the device. Because of this, tip-to-ground resistance is another important issue that must be checked daily.

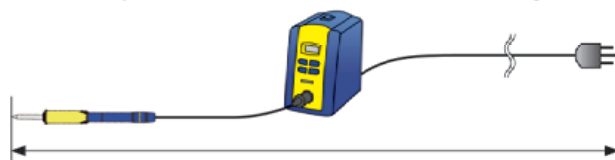

Features for FG-100B

Minimize individual differences in how to complete measurement and read result.

* Image photo below

AUTO HOLD function and MAX HOLD function cannot be used at the same time.



1. AUTO HOLD Function

The measurement will end automatically when tip temperature is stabilized.

The measurement process will be the same no matter who does it.

2. MAX HOLD Function

Max measured tip temperature will be displayed.

This function can be useful for quality control of components and P.W.B.

3. Temperature Measurement Count Function

Number of tip temperature measurement will be automatically counted.

This function can be useful for control of changing sensor.

Temperature Sending Function

Measurement result by AUTO HOLD function or MAX HOLD function can be sent to a soldering station (FN-1010 : refer to P.18) through infrared.

This function can eliminate manual process of recording results, the time for the process, and human error.

Packing List

FG-100B	Unit, 006P 9 V Manganese dry battery (for trial), Instruction manual, Sensor (10 pcs)
FG-101	Unit, Fuse, Conduction wire, Sensor (10 pcs), Multi-adapter, European adapter, Ground clip, Power cord, Instruction manual

Specifications

Model No.	FG-100B
Power supply	006P 9 V dry battery (alkaline cell recommended)
Temperature resolution	1°C
Temperature measurement range	0 to 700°C
Temperature precision	±3°C (300 to 600°C) ±5°C (other than above)
Temperature sensor*	K (CA) type thermocouple
Display	LCD: 3 1/2 digits
Operating environment	0 to 40°C, 20 to 90%RH (without condensation)
Environmental conditions	Applicable rated pollution degree 2 (according to IEC/UL 61010-1)
Dimensions**	68 (W) × 140 (H) × 38 (D) mm
Weight***	125 g

* The temperature sensor (No.191-212 or No.191-212C) can only be used to measure temperatures below 500°C. To measure higher temperatures, use an applicable temperature probe.

** Excluding protrusions

*** Without battery

Model No.	FG-101
Power consumption	2.8 W
Temperature resolution	1°C
Temperature measurement range	0 to 700°C
Temperature precision	±3°C (300 to 600°C) ±5°C (other than above)
Temperature sensor*	K (CA) type thermocouple
Voltage resolution	0.1 mV
Voltage measurement range	0 to 40 mV (AC)
Voltage precision	± (5% of reading + 1 digit)
Resistance resolution	0.1 Ω
Resistance measurement range	0 to 40 Ω
Resistance precision	± (5% of reading + 1 digit)
Display	LCD: 3 1/2 digits
Operating environment	0 to 40°C, 20 to 90%RH (without condensation)
Environmental conditions	Applicable rated pollution degree 2 (according to IEC/UL 61010-1)
Dimensions	200 (W) × 50 (H) × 120 (D) mm
Weight	1 kg

* The temperature sensor (No.191-212 or No.191-212C) can only be used to measure temperatures below 500°C. To measure higher temperatures, use an applicable temperature probe.

Option / Replacements

Part No.	Name	Specifications
A1310	Temperature probe	For solder bath and pot
C1541	Temperature probe	For hot air station
A1556	Sensor A	-
A1557	Sensor B	-
191-212	Sensor/10 pcs	-

FV-310

Heating Gun



- Stepless control on temperature and airflow for optimal settings
- Easy replacement of heating element
- Temperature range: 80 to 530°C
- Airflow range: 0.15 m³/min.

Packing List

FV-310	Unit, Instruction manual
--------	--------------------------



Provided in a carrying case

Specifications

Power Consumption	1000 W
Maximum Temperature*	530°C (80 to 530°C continuously variable)
Air Velocity	600 m/min.
Air Flow	0.15 to 0.25 m ³ /min.
Dimensions**	240 (W) × 190 (H) × 70 (D) mm
Weight**	0.6 kg

* Measured at the point 10 mm from the pipe.

** Without cord

Features

Stepless control on temperature and airflow for optimal settings

Fine control of temperature and airflow for a variety of application contributes to improvement of work efficiency.



Types of applications

A	Drying painting and putty
B	Peeling sticker
C	Shrinking
D	Heat shrink tubing
E	Curving plastic material

Temperature distribution chart

* The temperature and airflow volume are reference values; these values are not guaranteed.

Temperature control knob (TEMP.) Airflow control knob (AIR)	1	2	3	4	5
1 (0.15 m ³ /min.)	120 °C	175 °C	295 °C	425 °C	530 °C
2 (0.17 m ³ /min.)	110 °C	165 °C	270 °C	390 °C	505 °C
3 (0.2 m ³ /min.)	100 °C	145 °C	230 °C	320 °C	425 °C
4 (0.23 m ³ /min.)	90 °C	130 °C	205 °C	285 °C	380 °C
5 (0.25 m ³ /min.)	85 °C	115 °C	190 °C	270 °C	345 °C

Easy replacement of heating element

It requires only a screwdriver to remove pipe and replace heating element.

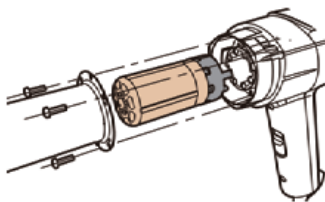

Safety design for fall-prevention during hands-free operation

Anti-slip rubbers on the back improve stability and safety during hands-free operation.



Use of stand, an option part, secures stability for hands-free application.

Stand
No.B5166

Option



Drying, painting and putty

Heat shrink tubing
Use of hook type nozzle and stand

Peeling sticker

Shrinking

Curving plastic material
Use of nozzle holder and single nozzle

Welding floor coverings
Use of nozzle holder and V type nozzle

Welding PVC sheet
Use of nozzle holder and spatula type nozzle along with roller

Spatula type nozzle 20 mm
No.N70-01

Spatula type nozzle 62 mm
No.N70-02

Hook type nozzle 20 mm
No.N70-03

Hook type nozzle 40 mm
No.N70-04

* Use this nozzle on the nozzle holder (N70-05).

Nozzle holder
No.N70-05

Single nozzle 12 mm
No.N70-06

V type nozzle for 4 mm welding rod
No.70-07

Roller
No.A1115

* Use this nozzle on the nozzle holder (N70-05).

* Use this nozzle on the nozzle holder (N70-05).

MELTER

Glue Gun



- Glue gun with temperature control function is applicable also to the adhesion of electronic components.
- Useful when fixing up sealing of carton boxes, dressing cases, and packages
- Only used with a stick-type adhesive that is easy to replenish (ø11.5 mm)

Applications

When using polyamide adhesives

- Reinforce and insulate soldered parts
- Fasten capacitors, resistors, etc.
- Fasten jumper wires
- Perform insulation potting for terminals
- Fasten the ends of coils
- Fasten deflecting yokes and variable coils

When using EVA adhesives

- Glue paper products (cardboard boxes, gift boxes, etc.)
- Fasten wood products
- Fasten plastics and metals
- Fasten textiles and shock absorbent packing
- Reseal products during packaging

Packing List

804	Unit, #13 Spanner, #14 Spanner, Instruction manual
-----	--

Specifications

Model No.	804
Power consumption	100 W
Melting temperature	100 to 200°C (variable)
Standard nozzle	ø2 mm (No. A1083)
Discharge capacity	900 g/h
Dimensions	207 (L) × 173 (H) × 45 (D) mm
Weight*	350 g

* Without cord

Adhesive Used

This model has been designed for use with stick adhesives (those hardened into the shape of a stick) only. Be sure to use adhesives recommended by HAKKO. (No. 810: UL94V-O recognized)

Part No.	810	811	812
Name	Polyamide	EVA	
Packing	1 kg		14 pcs
Color	Yellowish brown	Milky white	
Size	ø11.5 × 220 mm		
Viscosity	2300 cps. (2300 mPa·s)	5800 cps. (5800 mPa·s)	
Open time*	10 seconds	40 seconds	
Temperature at which adhesive is heat resistant	100°C	55°C	
Suitability	P.W.B.	○	—
	Wood	○	○
	Paper	○	○
	Metal	○	○
	Plastic	○	○
Packing	In aluminum foil bag	In polyethylene bag	In blister pack

Adhesives marked with ○ are more suited for that material than adhesives marked with ○.

* Application period

Topic Failure-Free Heat-Shrinking of Waterproof tube

By using FV-310 Heating Gun, and an optional nozzle, everyone can shrink waterproof heat-shrink tube, which is difficult work, quickly, beautifully and equally.

Using the optional nozzle shown below, the hot air from the nozzle flows along the hook-shaped baffle, so that the entire section of heat-shrink tube is shrunk quickly.



Tempertature distribution chart

* The temperature and airflow volume are reference values; these values are not guaranteed.

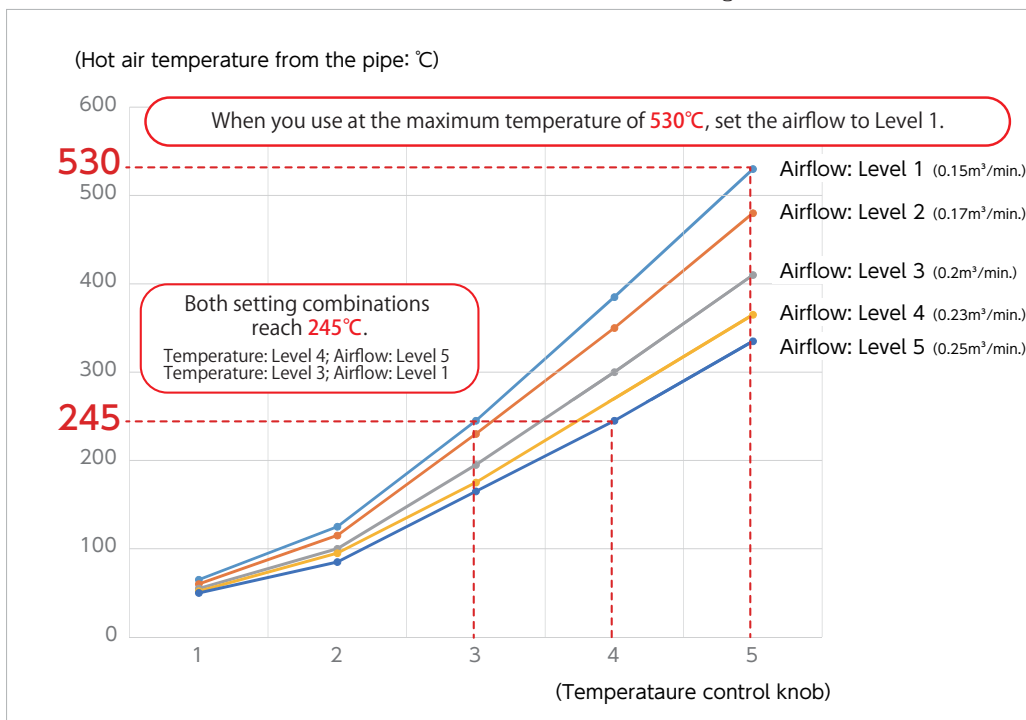

Although there is a click feeling, adjustment is stepless. Temperature and airflow suitable for the work can be set.



HEAD OFFICE

4-5, SHIOKUSA 2-CHOME, NANIWA-KU, OSAKA, 556-0024 JAPAN
TEL: +81-6-6561-3225 FAX: +81-6-6561-8466
<http://www.hakko.com> E-mail: sales@hakko.com

OVERSEAS AFFILIATES

U.S.A.

AMERICAN HAKKO PRODUCTS, INC.

28920 AVENUE WILLIAMS VALENCIA, CA 91355, U.S.A.
TEL: (661) 294-0090 FAX: (661) 294-0096
Toll Free (800)88-HAKKO
<http://www.hakkousa.com>

HONG KONG

HAKKO DEVELOPMENT CO., LTD.

ROOM 1504, EASTERN HARBOUR CENTRE,
28 HOI CHAK STREET, QUARRY BAY, HONG KONG.
TEL: 2811-5588 FAX: 2590-0217
<http://www.hakko.com.cn> E-mail: info@hakko.com.hk

SINGAPORE

HAKKO PRODUCTS PTE LTD

1, GENTING LINK #02-04
PERFECT ONE, SINGAPORE 349518
TEL: 6748-2277 FAX: 6744-0033
<http://www.hakko.com.sg> E-mail: sales@hakko.com.sg

Please access to the following address for the other sales affiliates and distributors.

<http://www.hakko.com>



ISO 9001
ISO 14001
JSAQ181, JSAE601

Production Section only is certified by ISO 9001.



CM001