

● Features:

1. Emitted Color : Super Yellow Green and Super Orange Red.
2. Lens Appearance : Water Clear
3. Bi-color type.
4. 1.6x1.25x0.4mm(0604) standard package
5. Suitable for all SMT assembly methods.
6. Compatible with infrared and vapor phase reflow solder process.
7. Compatible with automatic placement equipment.

● Applications:

1. Automotive : Dashboards, stop lamps, turn signals.
2. Backlighting : LCDs, Key pads advertising.
3. Status indicators : Consumer & industrial electronics.
4. General use.

● Package Dimensions:

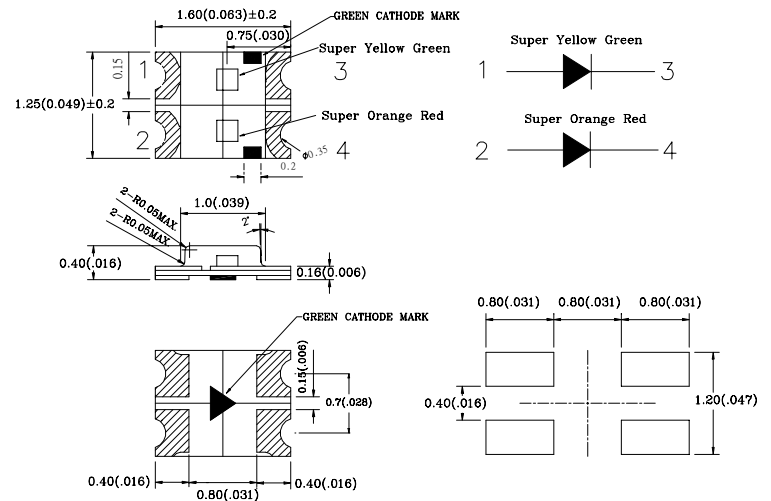

NOTES:

1. All dimensions are in millimeters (inches).
2. Tolerance is $\pm 0.10\text{mm}$ ($0.004''$) unless otherwise specified.
3. Specifications are subject to change without notice.

● Absolute Maximum Ratings(Ta=25°C)

Parameter	Symbol	Super Yellow Green	Super Orange Red	Unit
Power Dissipation	Pd	100	100	mW
Forward Current	I _F	30	30	mA
Peak Forward Current * 1	I _{FP}	100	100	mA
Reverse Voltage	V _R	5		V
Operating Temperature	Topr	-25°C ~ 80°C		-
Storage Temperature	Tstg	-30°C ~ 85°C		-
Soldering Temperature	Tsol	See Page6		-

* 1 Condition for I_{FP} is pulse of 1/10 duty and 0.1msec width.

● Electrical and optical characteristics(Ta=25°C)

Parameter	Symbol	Condition	Color	Min.	Typ.	Max.	Unit
Forward Voltage	V _f	I _F =20mA	Super Yellow Green Super Orange Red	-	2.0 2.0	2.6 2.6	V
Luminous Intensity	I _v	I _F =20mA	Super Yellow Green Super Orange Red	18.5 63.0	35.0 100.0	-	mcd
Reverse Current	I _R	V _R =5V	Super Yellow Green Super Orange Red	-	-	100	μA
Peak Wave Length	λ _p	I _F =20mA	Super Yellow Green Super Orange Red	-	570 630	-	nm
Dominant Wave Length	λ _d	I _F =20mA	Super Yellow Green Super Orange Red	566 615	-	576 625	nm
Spectral Line Half-width	Δλ	I _F =20mA	Super Yellow Green Super Orange Red	-	30 17	-	nm
Veiwng Angle	2θ _{1/2}	I _F =20mA	Super Yellow Green Super Orange Red	-	120	-	deg

● Typical Electro-Optical Characteristics Curves

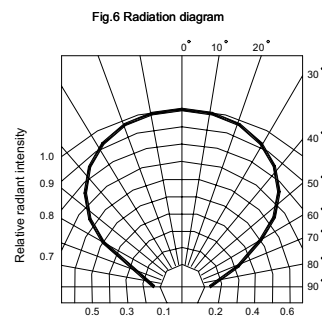
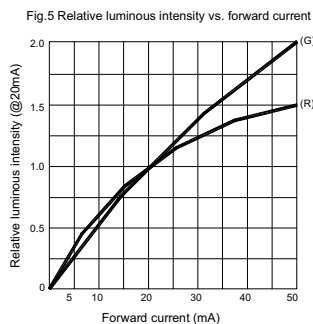
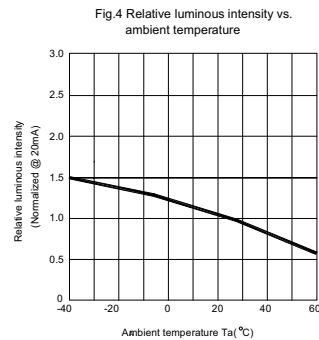
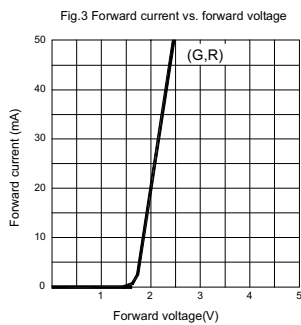
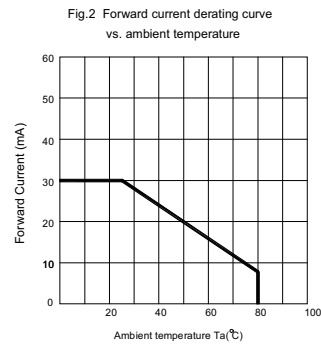
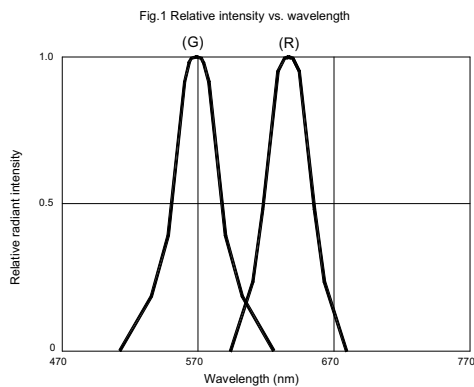

● Tapping and packaging specifications(Units: mm)

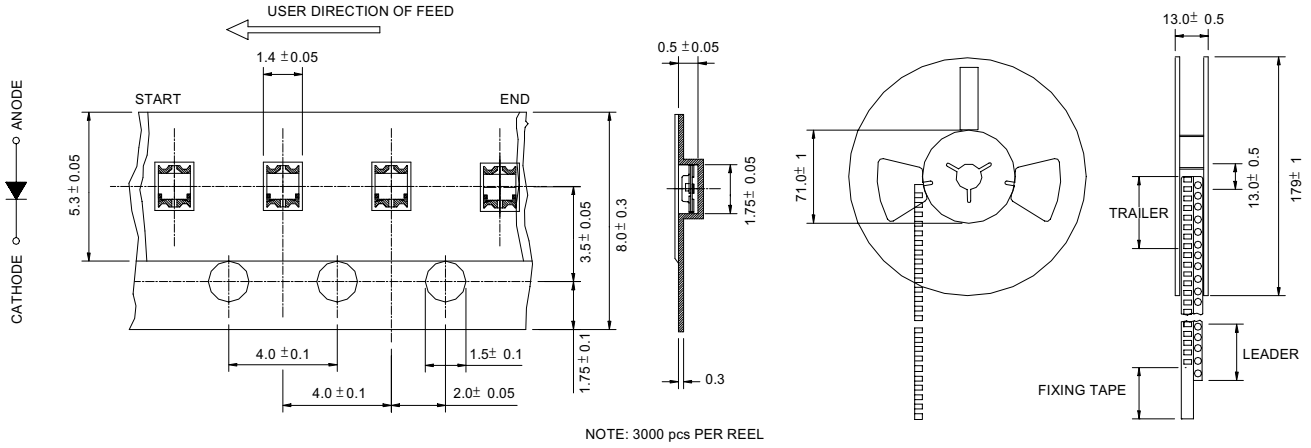

● Package Method:(unit:mm)

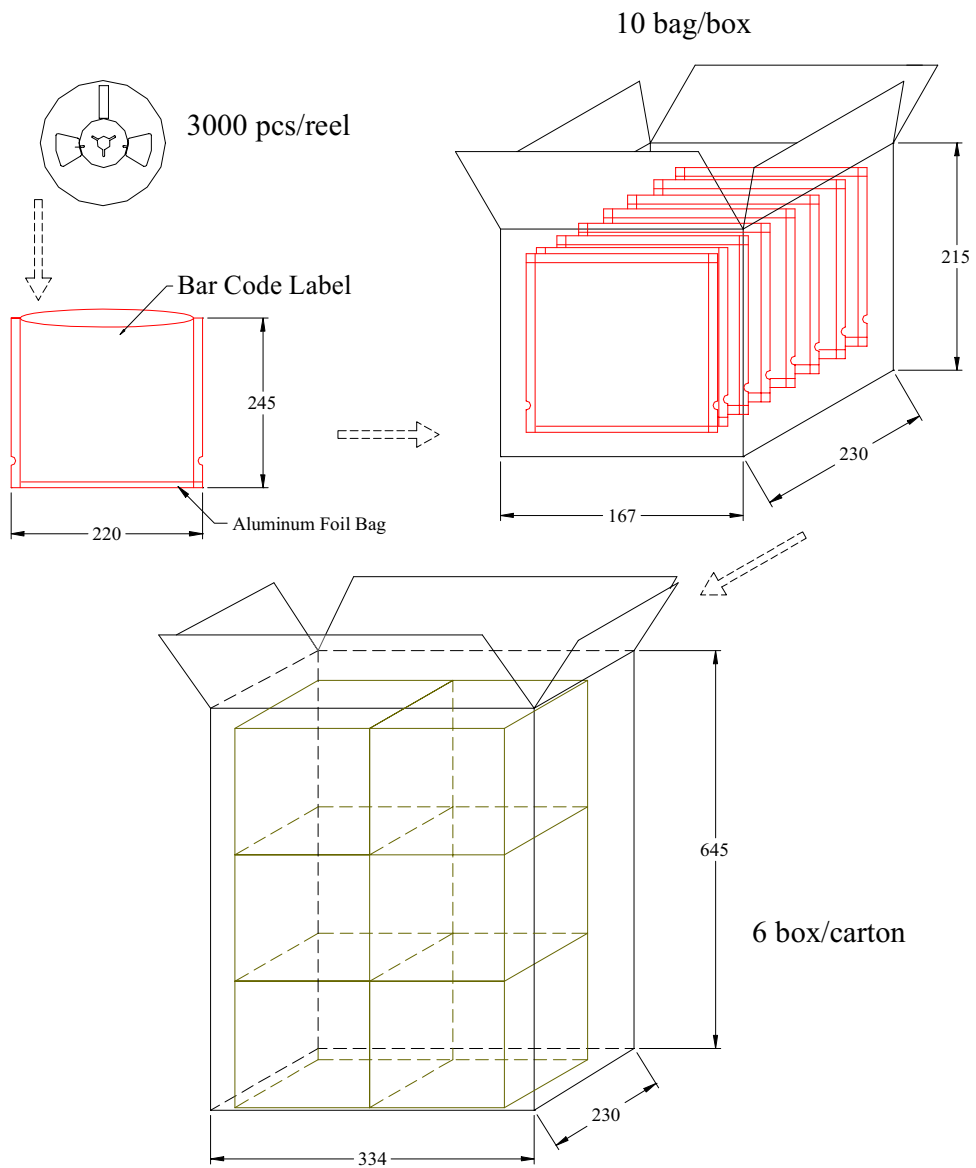



BRIGHT LED ELECTRONICS CORP.

BL-HGEJE36H-TRB

● Bin Limits

COLOR	Super Yellow Green				Super Orange Red			
IF(mA)	20mA				20mA			
ITEM	IV (mcd)		λ d (nm)		IV (mcd)		λ d (nm)	
Spec	18.5-63.0		566-576		63.0-210.0		615-625	
NO.	MIN	MAX	MIN	MAX	MIN	MAX	MIN	MAX
1	18.50	28.0	566	568	63.0	94.0	615	625
2					94.0	140.0		
3					140.0	210.0		
4			568	570	63.0	94.0		
5					94.0	140.0		
6					140.0	210.0		
7			570	572	63.0	94.0		
8					94.0	140.0		
9					140.0	210.0		
10			572	574	63.0	94.0		
11					94.0	140.0		
12					140.0	210.0		
13			574	576	63.0	94.0		
14					94.0	140.0		
15					140.0	210.0		
16	28.0	42.0	566	568	63.0	94.0	615	625
17					94.0	140.0		
18					140.0	210.0		
19			568	570	63.0	94.0		
20					94.0	140.0		
21					140.0	210.0		
22			570	572	63.0	94.0		
23					94.0	140.0		
24					140.0	210.0		
25			572	574	63.0	94.0		
26					94.0	140.0		
27					140.0	210.0		
28			574	576	63.0	94.0		
29					94.0	140.0		
30					140.0	210.0		
31	42.0	63.0	566	568	63.0	94.0	615	625
32					94.0	140.0		
33					140.0	210.0		
34			568	570	63.0	94.0		
35					94.0	140.0		
36					140.0	210.0		
37			570	572	63.0	94.0		
38					94.0	140.0		
39					140.0	210.0		
40			572	574	63.0	94.0		
41					94.0	140.0		
42					140.0	210.0		
43			574	576	63.0	94.0		
44					94.0	140.0		
45					140.0	210.0		

Iv : Tolerance for each Bin limit is ± 15 %
 λd: Tolerance for each Bin limit is ± 1 nm

● Reliability Test

Classification	Test Item	Reference Standard	Test Conditions	Result
Endurance Test	Operation Life	MIL-STD-750:1026 MIL-STD-883:1005 JIS-C-7021 :B-1	Connect with a power $I_f=20\text{mA}$ T_a =Under room temperature Test time=1,000hrs	0/20
	High Temperature High Humidity Storage	MIL-STD-202:103B JIS-C-7021 :B-11	$T_a=+65^\circ\text{C}\pm 5^\circ\text{C}$ RH=90%-95% Test time=240hrs	0/20
	High Temperature Storage	MIL-STD-883:1008 JIS-C-7021 :B-10	High $T_a=+85^\circ\text{C}\pm 5^\circ\text{C}$ Test time=1,000hrs	0/20
	Low Temperature Storage	JIS-C-7021 :B-12	Low $T_a=-35^\circ\text{C}\pm 5^\circ\text{C}$ Test time=1,000hrs	0/20
Environmental Test	Temperature Cycling	MIL-STD-202:107D MIL-STD-750:1051 MIL-STD-883:1010 JIS-C-7021 :A-4	$-35^\circ\text{C} \sim +25^\circ\text{C} \sim +85^\circ\text{C} \sim +25^\circ\text{C}$ 60min 20min 60min 20min Test Time=5cycle	0/20
	Thermal Shock	MIL-STD-202:107D MIL-STD-750:1051 MIL-STD-883:1011	$-35^\circ\text{C}\pm 5^\circ\text{C} \sim +85^\circ\text{C}\pm 5^\circ\text{C}$ 20min 20min Test Time=10cycle	0/20
	Solder Resistance	MIL-STD-202:201A MIL-STD-750:2031 JIS-C-7021 :A-1	Preheating : $140^\circ\text{C}-160^\circ\text{C}$, within 2 minutes. Operation heating : 235°C (Max.), within 10seconds. (Max.)	0/20

● Judgment criteria of failure for the reliability

Measuring items	Symbol	Measuring conditions	Judgement criteria for failure
Forward voltage	V_F (V)	$I_F=20\text{mA}$	Over $U_x1.2$
Reverse current	I_R (μA)	$V_R=5\text{V}$	Over U_x2
Luminous intensity	I_v (mcd)	$I_F=20\text{mA}$	Below $SX0.5$

Note: 1.U means the upper limit of specified characteristics. S means initial value.

2.Measurment shall be taken between 2 hours and after the test pieces have been returned to normal ambient conditions after completion of each test.

● Soldering :

1. Manual Of Soldering

The temperature of the iron tip should not be higher than 300°C (572°F) and Soldering within 3 seconds per solder-land is to be observed.

2. Reflow Soldering

Preheating : 140°C~160°C ±5°C ,within 2 minutes.

Operation heating : 235°C (Max.) within 10 seconds.(Max)

Gradual Cooling (Avoid quenching).

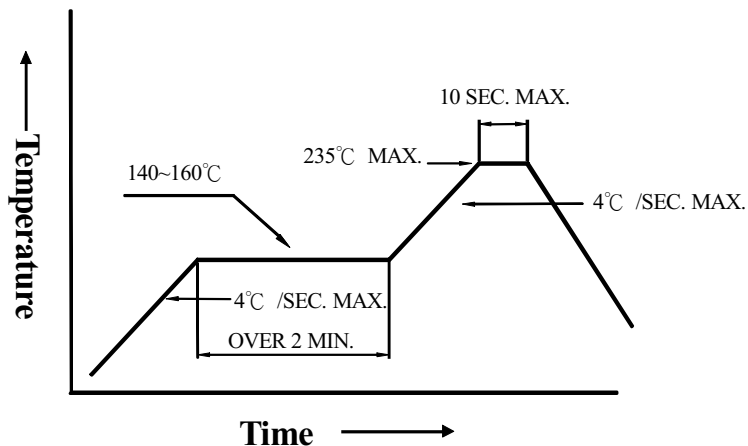

3. DIP soldering (Wave Soldering) :

Preheating : 120°C~150°C ,within 120~180 sec.

Operation heating : 245°C ±5°C within 5 sec. 260°C (Max)

Gradual Cooling (Avoid quenching).

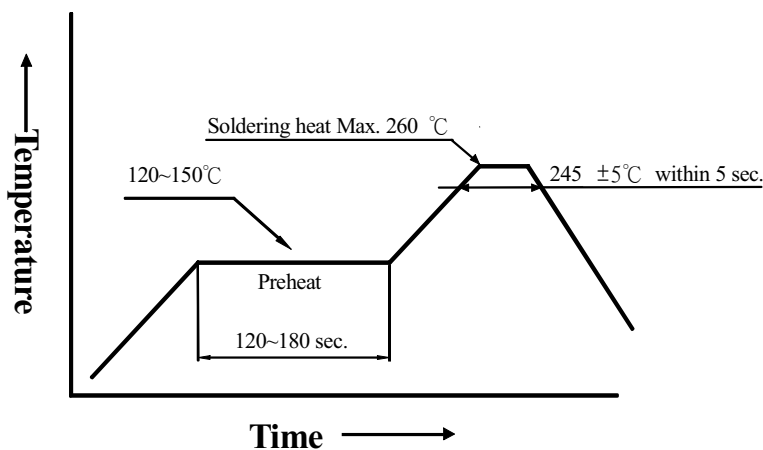

● Handling :

Care must be taken not to cause to the epoxy resin portion of BRIGHT LEDs while it is exposed to high temperature.

Care must be taken not rub the epoxy resin portion of BRIGHT LEDs with hard or sharp article such as the sand blast and the metal hook.

● Notes for designing:

Care must be taken to provide the current limiting resistor in the circuit so as to drive the BRIGHT LEDs within the rated figures. Also, caution should be taken not to overload BRIGHT LEDs with instantaneous voltage at the turning ON and OFF of the circuit.

When using the pulse drive care must be taken to keep the average current within the rated figures. Also, the circuit should be designed so as to be subjected to reverse voltage when turning off the BRIGHT LEDs.

● Storage:

In order to avoid the absorption of moisture, it is recommended to solder BRIGHT LEDs as soon as possible after unpacking the sealed envelope.

If the envelope is still packed, to store it in the environment as following:

- (1) Temperature : 5°C-30°C (41°F) Humidity : RH 60% Max.
- (2) After this bag is opened, devices that will be applied to infrared reflow, vapor-phase reflow, or equivalent soldering process must be:
 - a. Completed within 24 hours.
 - b. Stored at less than 30% RH.
- (3) Devices require baking before mounting, if:
 - (2) a or (2) b is not met.
- (4) If baking is required, devices must be baked under below conditions:
 - 12 hours at 60°C±3°C.

● Package and Label of Products:

- (1) Package: Products are packed in one bag of 3000 pcs (one taping reel) and a label is attached on each bag.
- (2) Label:

