

UR-Series

UL1077 Recognized Supplementary Protector

- DIN Rail Mounted
- 17.5mm width per pole
- Thermal Magnetic
- 480Y/277V AC, 50/60Hz
- 10kA Short Circuit Withstand Capacity
- Applications (on the load side of Branch Circuit Protection) include: Sensitive Electronics, Power Supplies, Appliance circuits, etc.



UR - Series	
Voltage Rating	480Y/ 277 VAC
Short Circuit Withstand Rating	0.5 - 10A (RC): 10 kA with no back-up fuse 8 - 63A (RC): 10 kA with UL-listed Class J back-up fuse; 5 kA with no back-up fuse
Calibration Temperature	30°C (86°F)
Ambient Temperature	-25°C to +55°C (-13°F to 131°F)
Storage Temperature	-40°C to +70°C (-40°F to 158°F)
Terminal Torque	max. 2.5Nm (22.2 lb.in)
Electrical Life	6000 switching cycles ON/ OFF
Mechanical Life	10000 switching cycles ON/ OFF
Vibration Resistance	> 15g according to DIN EN 60069-2-59 during a load with 1.05 x I _N
Resistance to mechanical shocks	25g @ 11ms

short circuit Withstand Ratings for UR-series supplementary protector

Trip Curve	Amp Range	Backup Protection	
		UL-Listed Class J Fuse up to 10kA	No Backup Fuse Required up to:
All	0.3 - 10A	70A	10kA
All	12 - 60A	4xRC*	5kA

*up to nearest rated current

Time versus Current Trip Curve

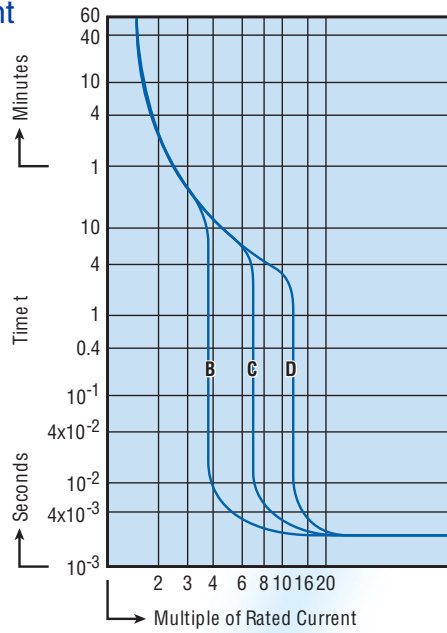

For exact trip curves and additional technical data please refer to pages 44-46.

Dimensions in mm

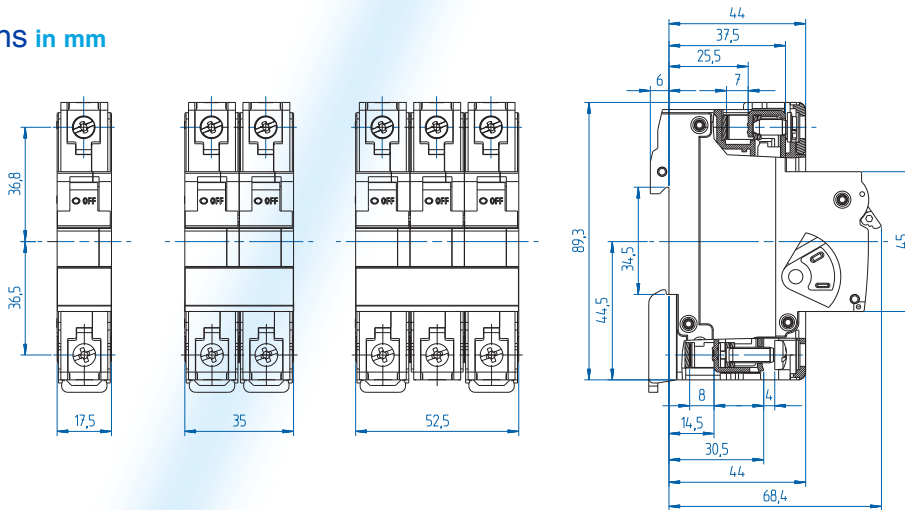

Application Overview

Trip-Characteristics*				Applications					
Characteristic Trip Boundaries				Lighting Wiring Protection Control Circuits	Business Equipment Appliances	Control Transformers	Power Supplies	General Electronics	Reactive Load
Thermal Trip		Magnetic Trip							
Must not Trip >100ms	Must Trip <1hr	Must not Trip >100ms	Must Trip at 100ms						
B-Characteristics									
1.13xRC	1.45xRC	3xRC	5xRC						
C-Characteristics									
1.13xRC	1.45xRC	5xRC	10xRC						
D-Characteristics									
1.13xRC	1.45xRC	10xRC	20xRC						

*The value of each characteristic is shown vertically beneath its corresponding heading.



Warning!

This information should only be used as a selection guide. The use of a Miniature Circuit Breaker/Supplementary Protector in an application with a certain Trip-Characteristic always requires prototype testing! It is the responsibility of the circuit design engineer to select the appropriate Miniature Circuit Breaker/Supplementary Protector for his specific application.

UL I 077

UR - Series B-Trip Characteristic

Application Examples:

Business equipment, wiring protection, lighting, appliances, control circuits, some motors and some electronic applications. Relatively long thermal trip delay but low magnetic trip point.



One Pole



Standard Pack: 12

Weight:

0.3A - 32A

1.75kg (3.86 lb.)

40A - 63A

2.07kg (4.56 lb.)

Rated Current	Rated Voltage	Type/ Cat. No.
0.5A	277VAC	1B05UR
1.0A	277VAC	1B1UR
2.0A	277VAC	1B2UR
3.0A	277VAC	1B3UR
4.0A	277VAC	1B4UR
5.0A	277VAC	1B5UR
6.0A	277VAC	1B6UR
8.0A	277VAC	1B8UR
10A	277VAC	1B10UR
12A	277VAC	1B12UR
13A	277VAC	1B13UR
15A	277VAC	1B15UR
16A	277VAC	1B16UR
20A	277VAC	1B20UR
25A	277VAC	1B25UR
30A	277VAC	1B30UR
32A	277VAC	1B32UR
40A	277VAC	1B40UR
50A	277VAC	1B50UR
60A	277VAC	1B60UR
63A*	277VAC	1B63UR



Standard Pack: 4

Weight:

0.3A - 32A

1.75kg (3.86 lb.)

40A - 63A

2.07kg (4.56 lb.)

Three Pole

Rated Current	Rated Voltage	Type/ Cat. No.
0.5A	480Y/277VAC	3B05UR
1.0A	480Y/277VAC	3B1UR
2.0A	480Y/277VAC	3B2UR
3.0A	480Y/277VAC	3B3UR
4.0A	480Y/277VAC	3B4UR
5.0A	480Y/277VAC	3B5UR
6.0A	480Y/277VAC	3B6UR
8.0A	480Y/277VAC	3B8UR
10A	480Y/277VAC	3B10UR
12A	480Y/277VAC	3B12UR
13A	480Y/277VAC	3B13UR
15A	480Y/277VAC	3B15UR
16A	480Y/277VAC	3B16UR
20A	480Y/277VAC	3B20UR
25A	480Y/277VAC	3B25UR
30A	480Y/277VAC	3B30UR
32A	480Y/277VAC	3B32UR
40A	480Y/277VAC	3B40UR
50A	480Y/277VAC	3B50UR
60A	480Y/277VAC	3B60UR
63A*	480Y/277VAC	3B63UR

Two Pole



Standard Pack: 6

Weight:

0.3A - 32A

1.75kg (3.86 lb.)

40A - 63A

2.07kg (4.56 lb.)

Rated Current	Rated Voltage	Type/ Cat. No.
0.5A	480Y/277VAC	2B05UR
1.0A	480Y/277VAC	2B1UR
2.0A	480Y/277VAC	2B2UR
3.0A	480Y/277VAC	2B3UR
4.0A	480Y/277VAC	2B4UR
5.0A	480Y/277VAC	2B5UR
6.0A	480Y/277VAC	2B6UR
8.0A	480Y/277VAC	2B8UR
10A	480Y/277VAC	2B10UR
12A	480Y/277VAC	2B12UR
13A	480Y/277VAC	2B13UR
15A	480Y/277VAC	2B15UR
16A	480Y/277VAC	2B16UR
20A	480Y/277VAC	2B20UR
25A	480Y/277VAC	2B25UR
30A	480Y/277VAC	2B30UR
32A	480Y/277VAC	2B32UR
40A	480Y/277VAC	2B40UR
50A	480Y/277VAC	2B50UR
60A	480Y/277VAC	2B60UR
63A*	480Y/277VAC	2B63UR



Add-on Neutral Pole

Rated Current	Rated Voltage	Type/ Cat. No.
0.3-63A	277/480VAC	N63UM

Standard Pack: 5

Weight:

0.775kg (1.71)

Standard Dual Connection Terminal

- Box clamp terminals
Top: 18-3 AWG;
Bottom: 18-2 AWG
(Line/Load reversible)
- Ring tongue terminals

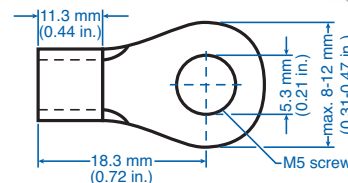
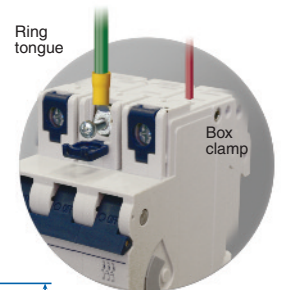

* May differ by manufacturer. Top terminal ring tongue max. thickness 1.6mm.

*63A is not UL Recognized.

UR - Series C-Trip Characteristic

Application Examples:

Low inrush motors, lighting, wiring protection, appliances, business equipment, and control circuit applications. Relatively long thermal trip delay and medium magnetic trip point.



One Pole



Standard Pack: 12
Weight:
0.3A - 32A
1.75kg (3.86 lb.)
40A - 63A
2.07kg (4.56 lb.)

Rated Current	Rated Voltage	Type/ Cat. No.
0.5A	277VAC	1C05UR
1.0A	277VAC	1C1UR
2.0A	277VAC	1C2UR
3.0A	277VAC	1C3UR
4.0A	277VAC	1C4UR
5.0A	277VAC	1C5UR
6.0A	277VAC	1C6UR
8.0A	277VAC	1C8UR
10A	277VAC	1C10UR
12A	277VAC	1C12UR
13A	277VAC	1C13UR
15A	277VAC	1C15UR
16A	277VAC	1C16UR
20A	277VAC	1C20UR
25A	277VAC	1C25UR
30A	277VAC	1C30UR
32A	277VAC	1C32UR
40A	277VAC	1C40UR
50A	277VAC	1C50UR
60A	277VAC	1C60UR
63A*	277VAC	1C63UR

Three Pole



Standard Pack: 4
Weight:
0.3A - 32A
1.75kg (3.86 lb.)
40A - 63A
2.07kg (4.56 lb.)

Rated Current	Rated Voltage	Type/ Cat. No.
0.5A	480Y/277VAC	3C05UR
1.0A	480Y/277VAC	3C1UR
2.0A	480Y/277VAC	3C2UR
3.0A	480Y/277VAC	3C3UR
4.0A	480Y/277VAC	3C4UR
5.0A	480Y/277VAC	3C5UR
6.0A	480Y/277VAC	3C6UR
8.0A	480Y/277VAC	3C8UR
10A	480Y/277VAC	3C10UR
12A	480Y/277VAC	3C12UR
13A	480Y/277VAC	3C13UR
15A	480Y/277VAC	3C15UR
16A	480Y/277VAC	3C16UR
20A	480Y/277VAC	3C20UR
25A	480Y/277VAC	3C25UR
30A	480Y/277VAC	3C30UR
32A	480Y/277VAC	3C32UR
40A	480Y/277VAC	3C40UR
50A	480Y/277VAC	3C50UR
60A	480Y/277VAC	3C60UR
63A*	480Y/277VAC	3C63UR

Two Pole



Standard Pack: 6
Weight:
0.3A - 32A
1.75kg (3.86 lb.)
40A - 63A
2.07kg (4.56 lb.)

Rated Current	Rated Voltage	Type/ Cat. No.
0.5A	480Y/277VAC	2C05UR
1.0A	480Y/277VAC	2C1UR
2.0A	480Y/277VAC	2C2UR
3.0A	480Y/277VAC	2C3UR
4.0A	480Y/277VAC	2C4UR
5.0A	480Y/277VAC	2C5UR
6.0A	480Y/277VAC	2C6UR
8.0A	480Y/277VAC	2C8UR
10A	480Y/277VAC	2C10UR
12A	480Y/277VAC	2C12UR
13A	480Y/277VAC	2C13UR
15A	480Y/277VAC	2C15UR
16A	480Y/277VAC	2C16UR
20A	480Y/277VAC	2C20UR
25A	480Y/277VAC	2C25UR
30A	480Y/277VAC	2C30UR
32A	480Y/277VAC	2C32UR
40A	480Y/277VAC	2C40UR
50A	480Y/277VAC	2C50UR
60A	480Y/277VAC	2C60UR
63A*	480Y/277VAC	2C63UR

Add-on Neutral Pole



Rated Current	Rated Voltage	Type/ Cat. No.
0.3-63A	277/480VAC	N63UM

Standard Pack: 5
Weight:
0.775kg (1.71)

Standard Dual Connection Terminal

- Box clamp terminals
Top: 18-3 AWG;
Bottom: 18-2 AWG
(Line/Load reversible)
- Ring tongue terminals

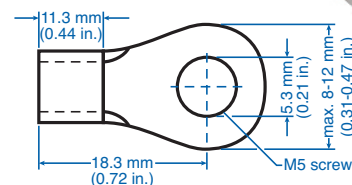
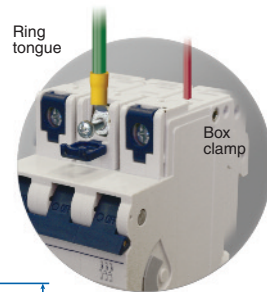

* May differ by manufacturer. Top terminal ring tongue max. thickness 1.6mm.

*63A is not UL Recognized.



UR - Series D-Trip Characteristic

Application Examples:

Control transformers, power supplies, reactive loads. Relatively long thermal trip delay and very high magnetic trip point.



One Pole

Rated Current	Rated Voltage	Type/ Cat. No.
0.5A	277VAC	1D05UR
1.0A	277VAC	1D1UR
2.0A	277VAC	1D2UR
3.0A	277VAC	1D3UR
4.0A	277VAC	1D4UR
5.0A	277VAC	1D5UR
6.0A	277VAC	1D6UR
8.0A	277VAC	1D8UR
10A	277VAC	1D10UR
12A	277VAC	1D12UR
13A	277VAC	1D13UR
15A	277VAC	1D15UR
16A	277VAC	1D16UR
20A	277VAC	1D20UR
25A	277VAC	1D25UR
30A	277VAC	1D30UR
32A	277VAC	1D32UR
40A	277VAC	1D40UR
50A	277VAC	1D50UR
60A	277VAC	1D60UR
63A*	277VAC	1D63UR

Standard Pack: 12

Weight:

0.3A - 32A
1.75kg (3.86 lb.)
40A - 63A
2.07kg (4.56 lb.)



Three Pole

Rated Current	Rated Voltage	Type/ Cat. No.
0.5A	480Y/277VAC	3D05UR
1.0A	480Y/277VAC	3D1UR
2.0A	480Y/277VAC	3D2UR
3.0A	480Y/277VAC	3D3UR
4.0A	480Y/277VAC	3D4UR
5.0A	480Y/277VAC	3D5UR
6.0A	480Y/277VAC	3D6UR
8.0A	480Y/277VAC	3D8UR
10A	480Y/277VAC	3D10UR
12A	480Y/277VAC	3D12UR
13A	480Y/277VAC	3D13UR
15A	480Y/277VAC	3D15UR
16A	480Y/277VAC	3D16UR
20A	480Y/277VAC	3D20UR
25A	480Y/277VAC	3D25UR
30A	480Y/277VAC	3D30UR
32A	480Y/277VAC	3D32UR
40A	480Y/277VAC	3D40UR
50A	480Y/277VAC	3D50UR
60A	480Y/277VAC	3D60UR
63A*	480Y/277VAC	3D63UR

Standard Pack: 4

Weight:

0.3A - 32A
1.75kg (3.86 lb.)
40A - 63A
2.07kg (4.56 lb.)



Two Pole

Rated Current	Rated Voltage	Type/ Cat. No.
0.5A	480Y/277VAC	2D05UR
1.0A	480Y/277VAC	2D1UR
2.0A	480Y/277VAC	2D2UR
3.0A	480Y/277VAC	2D3UR
4.0A	480Y/277VAC	2D4UR
5.0A	480Y/277VAC	2D5UR
6.0A	480Y/277VAC	2D6UR
8.0A	480Y/277VAC	2D8UR
10A	480Y/277VAC	2D10UR
12A	480Y/277VAC	2D12UR
13A	480Y/277VAC	2D13UR
15A	480Y/277VAC	2D15UR
16A	480Y/277VAC	2D16UR
20A	480Y/277VAC	2D20UR
25A	480Y/277VAC	2D25UR
30A	480Y/277VAC	2D30UR
32A	480Y/277VAC	2D32UR
40A	480Y/277VAC	2D40UR
50A	480Y/277VAC	2D50UR
60A	480Y/277VAC	2D60UR
63A*	480Y/277VAC	2D63UR

Standard Pack: 6

Weight:

0.3A - 32A
1.75kg (3.86 lb.)
40A - 63A
2.07kg (4.56 lb.)



Add-on Neutral Pole

Rated Current	Rated Voltage	Type/ Cat. No.
0.3-63A	277/480VAC	N63UM

Standard Pack: 5

Weight:

0.775kg (1.71)

Standard Dual Connection Terminal

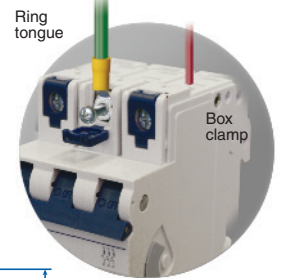

- Box clamp terminals
Top: 18-3 AWG;
Bottom: 18-2 AWG
(Line/Load reversible)
- Ring tongue terminals

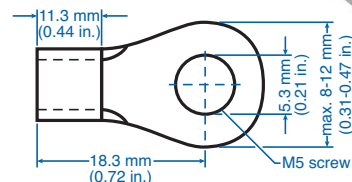

* May differ by manufacturer. Top terminal ring tongue max. thickness 1.6mm.

*63A is not UL Recognized.



Auxiliary Contact, Alarm Switch



Type/ Cat No.	Description	Contacts Type	Std Pk
H10UM	1 Auxiliary Contact	1NO	6
H11UM	2 Auxiliary Contacts	1NO + 1NC	6
H12UM	3 Auxiliary Contacts	1NO + 2NC	6
H21UM	3 Auxiliary Contacts	2NO + 1NC	6
HLS11M	1 Auxiliary/ 1 Signal Contacts	1NO + 1 Signal	6

Rated Operating Currents	10A@240V AC 3A@110V AC 1A@220V AC
Minimum Contact Load	1mA @ 24VDC
Torque	max. 0.8Nm (7 lb.in)
Wire Range:	
Single Wire	1.0mm ² - 2.5mm ² (18-14 AWG)
Stranded Wire	1.0mm ² - 1.5mm ² (18-16 AWG)
Stranded Wire with Ferrule	1.0mm ² - 1.5mm ² (18-16 AWG)

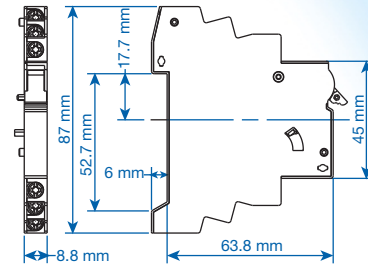

Dimensions HxxUM.

Shunt Trip



Type/ Cat No.	Description	Max. Operating Current @ Un	Std Pk
FA12UM	12 V AC/DC	1.3A	5
FA24UM	24 V AC/DC	0.6A	5
FA48UM	48 - 72 V AC/DC	0.2A	5
FA110UM	110 - 240 V AC/DC, 277V AC	0.25A @ 110V 0.5A @ 240V 0.58A @ 277V	5

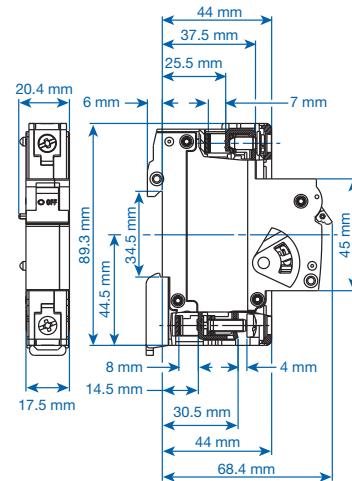

Dimensions FAxXUM, UA120UM, N63UM.

Undervoltage Trip

Type/ Cat No.	Line Voltage V _E	Std Pk
UA120UM	120 VAC, 60Hz	5

Reset-Hold Voltage = 0.85 x V_E

Drop-Out Voltage = 0.35 ~ 0.7 x V_E

Neutral Pole



Type/ Cat No.	Rated Current In	Rated Voltage	Std Pk
N63UM	0.3 - 63A	277Y/ 480 VAC	5



Mounting Screw 34mm

to connect the auxiliary contact and shunt trip or neutral Pole to the circuit breaker.

Type/ Cat No.	Standard Pack
E983419	10

Touch Protection Caps

to cover the terminal screws on the switching devices, neutral Poles and shunt trips for increased touch protection.



Type/ Cat No.	Standard Pack
BS.UJ	100



Lock-out Adapter

Type/ Cat No.	Standard Pack
EASS	10

ULI077

UR Series Trip Curves

B Trip Curve

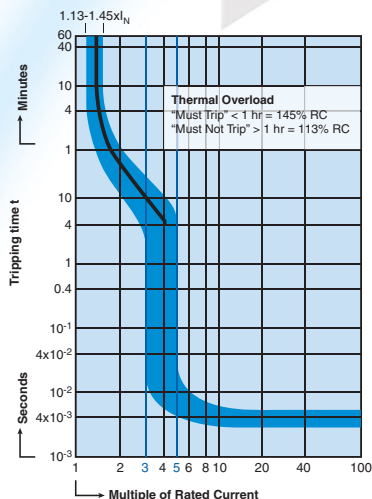

1.0A Through 10A Rated Current

C Trip Curve

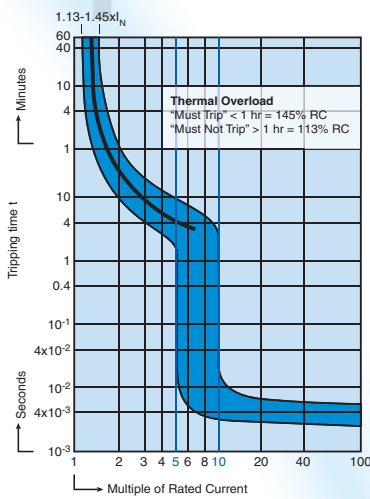

0.3A Through 10A Rated Current

D Trip Curve

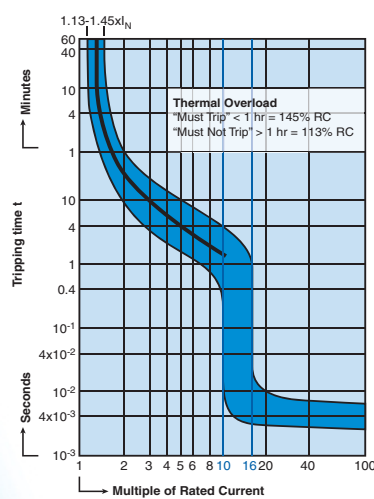

0.3A Through 10A Rated Current

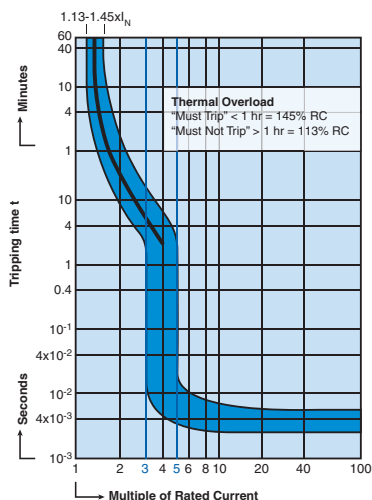

13A Through 63A Rated Current

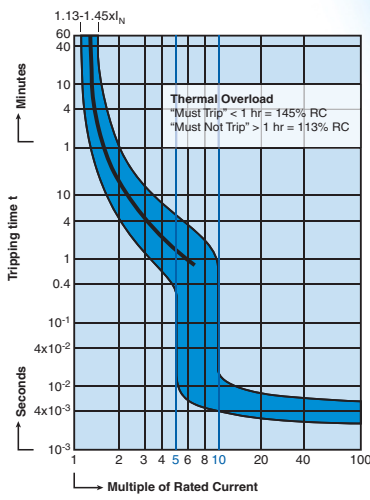

13A Through 63A Rated Current

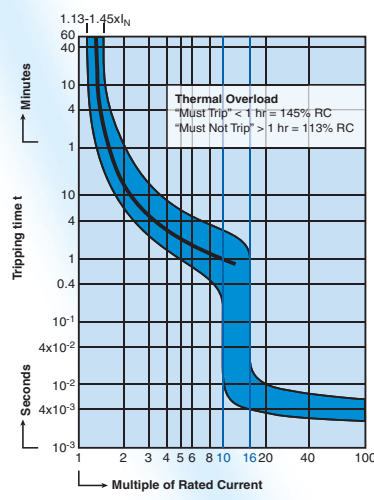

13A Through 63A Rated Current

“B” Magnetic Trip Parameters

Rated current 1.0A to 63A.

1. Hold for a minimum of 100ms at surge of 3 times rated current.
2. Trip in under 100ms at 5 times rated current.

“C” Magnetic Trip Parameters

Rated current 0.3A to 63A.

1. Hold for a minimum of 100ms at surge of 5 times rated current.
2. Trip in under 100ms at 10 times rated current.

“D” Magnetic Trip Parameters

Rated current 0.3A to 63A.

1. Hold for a minimum of 100ms at surge of 10 times rated current.
2. Trip in under 100ms at 16 times rated current.

UR Series Internal Resistance

Rated Current (A)	Trip Characteristic		
	B (Ohm)	C (Ohm)	D (Ohm)
0.5	-	6.8540	6.0009
1.0	1.7000	1.7000	1.7560
2.0	0.4190	0.4190	0.4190
3.0	0.2020	0.2020	0.2020
4.0	0.1090	0.1090	0.1090
5.0	0.0654	0.0654	0.0654
6.0	0.0528	0.0528	0.0491
8.0	0.0278	0.0278	0.0240
10	0.0216	0.0216	0.0187
12/ 13	0.0113	0.0084	0.0085
15/ 16	0.0085	0.0085	0.0076
20	0.0067	0.0067	0.0064
25	0.0050	0.0050	0.0041
30/ 32	0.0032	0.0032	0.0027
40	0.0025	0.0025	0.0022
50	0.0019	0.0019	0.0018
60/ 63*	0.0018	0.0018	0.0017

Mounting Instructions for UL489, UL508 and UL1077 Accessories

Neutral / Shunt Trip plus possibly Auxiliary Contact

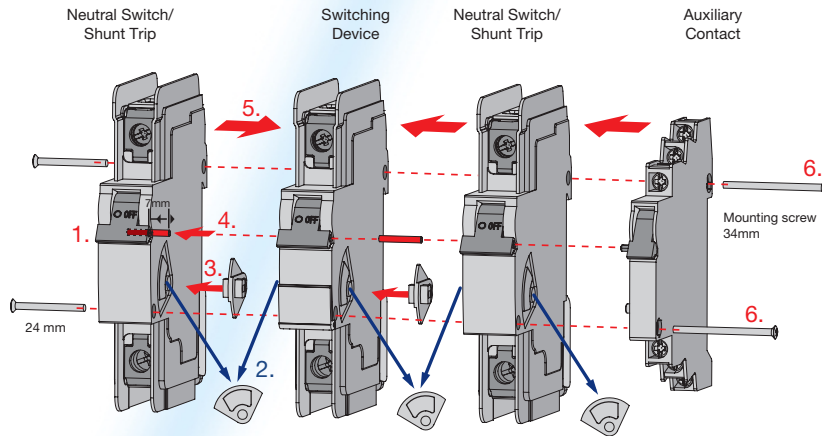

1. Neutral Poles N63UM, N32UL, N63UL or Shunt Trips FA..UM, FA..UL can be mounted on right or left side of device.
2. Bring blue knob of all devices into "OFF" position.
3. Remove grey cover from the switching device and attachment.
4. Insert drive plate between switching device and Neutral Poles N63UM, N32UL, N63UL or Shunt Trips FA..UM, FA..UL.
5. Insert connecting pin into knob.
6. Combine switching device and Neutral Poles N63UM, N32UL, N63UL or Shunt Trips FA..UM, FL..UL.
7. Screw device together.
8. Possibility of mounting Auxiliary contact H...UM, H...UL additionally on the right only, different screw type (see E983419 accessories) necessary.

Auxiliary Contact

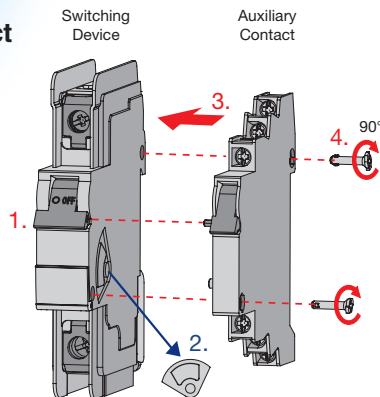

1. Auxiliary can be mounted on right side of device only.
2. Bring blue knob of both devices into "OFF" position.
3. Remove grey cover from switching device.
4. Combine switching device and Auxiliary Contact H...UM, H...UL.
5. Insert connection screws and connect the two devices by turning the screws by 90°.
6. After mounting close and open to check operation.